

## 1.5" microOLED

Intelligent GOLDELOX Display Module

$\mu$ OLED-128-G2

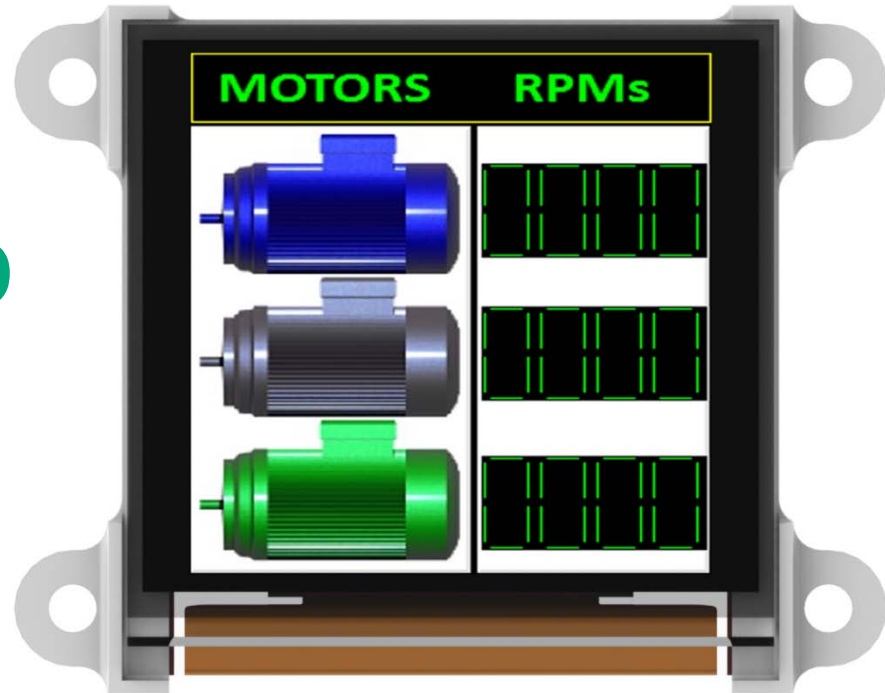

**4D SYSTEMS**  
*TURNING TECHNOLOGY INTO ART*

# MESSAGE FROM THE CEO

---

To our valued customers,

Thank you for your interest in 4D Systems and the products we have to offer.

We are constantly looking for ways to improve our customer experience and it is hoped that a Product Brief such as this, can instil confidence in choosing 4D Systems as your supplier of superior embedded electronic products.

We invite you to showcase our latest release and thank you again for your continued support.

---

Atilla Aknar  
Founder & CEO

# Table of Contents

1. Overview of the $\mu$ OLED-128-G2	4
2. Module Features	5
3. GOLDELOX Processor	6
4. 1.5" PMOLED Display	7
5. micro-SD Card Slot	8
6. Powering Your Device	9
7. What you Need	10
8. Development Environment	11
9. Getting Started	12
10. Mechanical Dimensions	13

# 1. Overview of the $\mu$ OLED-128-G2

The  $\mu$ OLED-128-G2 is an Intelligent Display Module that serves as the perfect embedded display solution for any product design that requires the brilliance of colour, animation or images all on a 1.5" OLED display.

Embedded at the heart of the design is the **GOLDELOX** Graphics Processor, which is driven by a highly optimised virtual core engine; EVE (Extensible Virtual Engine).

An extensive range of hardware and software peripherals have been integrated into the design, to give the user freedom to adapt the module to suit almost any application, such as; a **1.5" PMOLED** display, micro-SD card connector, GPIOs that can be used for Digital Input/Output, Analogue Input, One-Wire and Sound Generation.

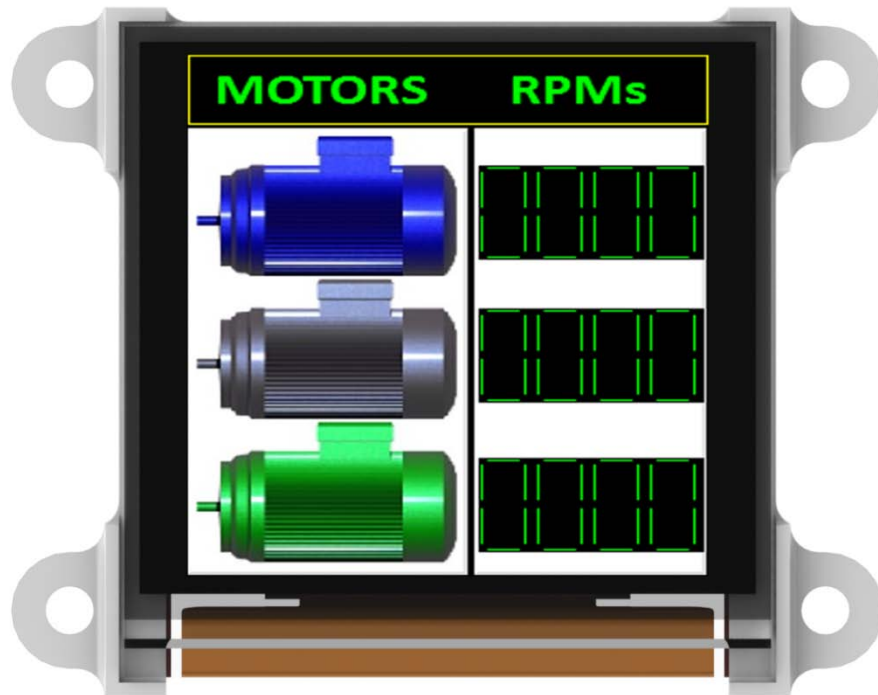

## 2. Module Features

- 01 1.5" PMOLED Screen
- 02 128 x 128 Resolution with 65K True to Life Colours
- 03 GOLDELOX Graphics Processor
- 04 10KB FLASH Memory, 510Bytes RAM
- 05 1 x UART Serial port
- 06 2 x GPIOs

Function	IO1	IO2
Digital Input	Yes	Yes
Digital Output	Yes	Yes
A/D Conversion 8/10 bits	Yes	No
Dallas 1-Wire Support	Yes	Yes
Sound Generation, RTTL Tunes	Yes	Yes
Joystick – 5 Position Multiswitch	Yes	No

- 07 1 x 32 bit free running System timer with 1ms resolution
- 08 4 x 16 bit timers with 1ms resolution
- 09 2 x 5 Pin Interface
- 10 micro-SD Card Slot
- 11 4 x Mounting tabs with 3mm holes
- 12 Light weight at only ~11gm

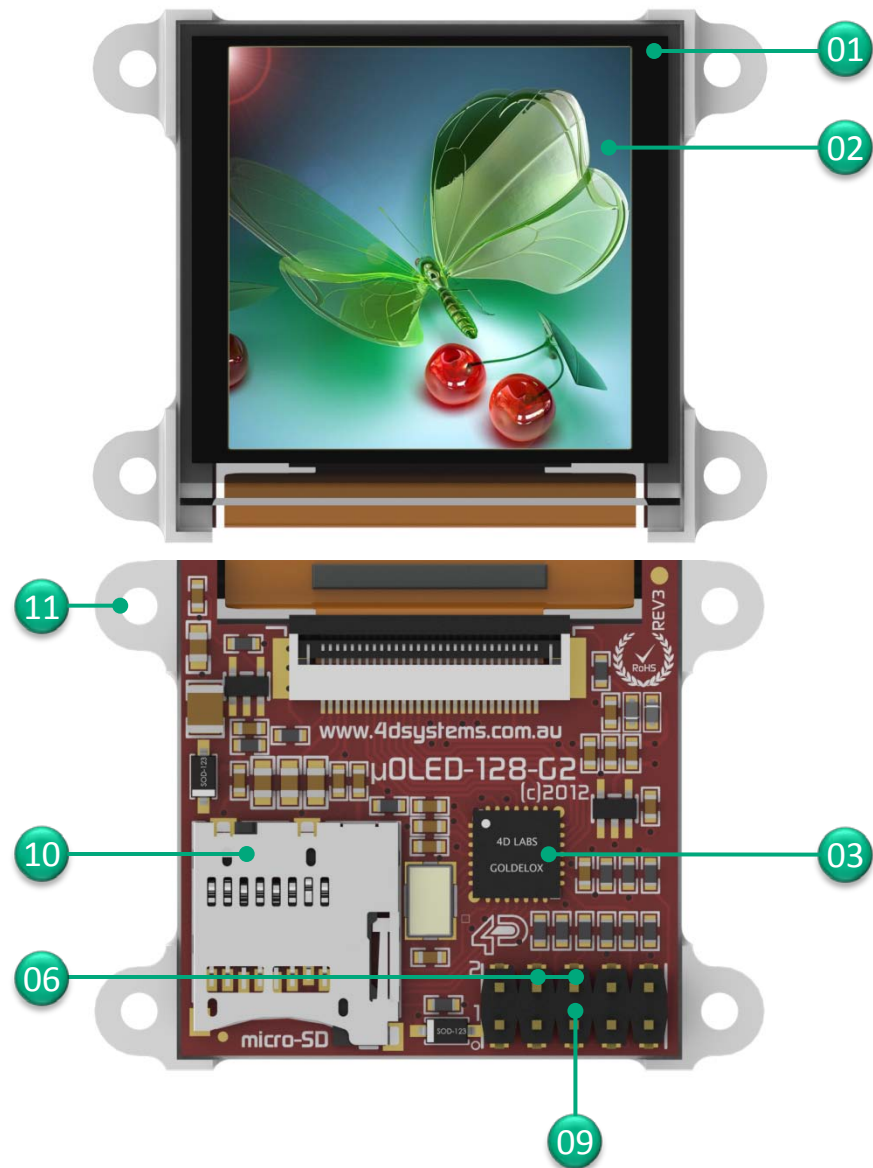

# 3. GOLDELOX Processor

At the core of the **μOLED-128-G2** design lies the **GOLDELOX** Graphics Processor. It has an array of dedicated graphics controls, supported by an ample supply of integrated peripherals.

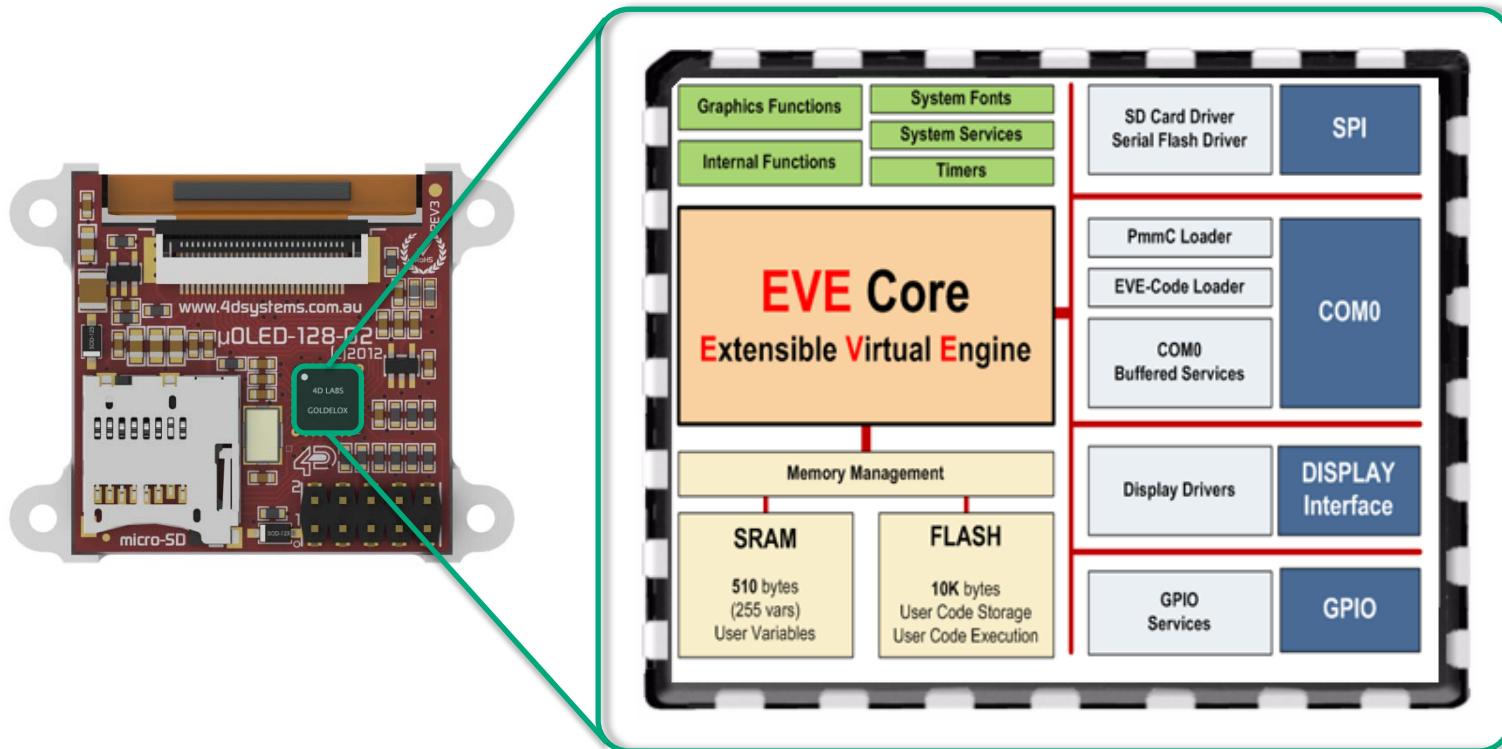

The GOLDELOX offers a complete suite of features, crafted to be at the forefront of any product requiring colour, animation, images and sound. The GOLDELOX is also powerful enough to control and communicate with peripheral devices over SPI, One Wire or Serial Port.

## 4. 1.5'' PMOLED Display

The **μOLED-128-G2** has a **1.5''** PMOLED display at the forefront of the design that exhibits the power and capabilities of the GOLDELOX processor. Combining a resolution of **128x128** pixels with **65K** True to Life colours, the μOLED-128-G2 delivers an astounding plethora of colours perfect for animations, slideshows and other multimedia presentations.



## 5. micro-SD Card Slot

The **μOLED-128-G2** supports **micro-SD** memory cards via the on-board micro-SD connector. This provides the user with expandable memory space suitable for all multimedia file retrieval; such as images, animations and movie clips, as well as data logging applications.

Supports up to 2GB micro-SD as well as micro-SDHC memory cards starting from 4GB and above.

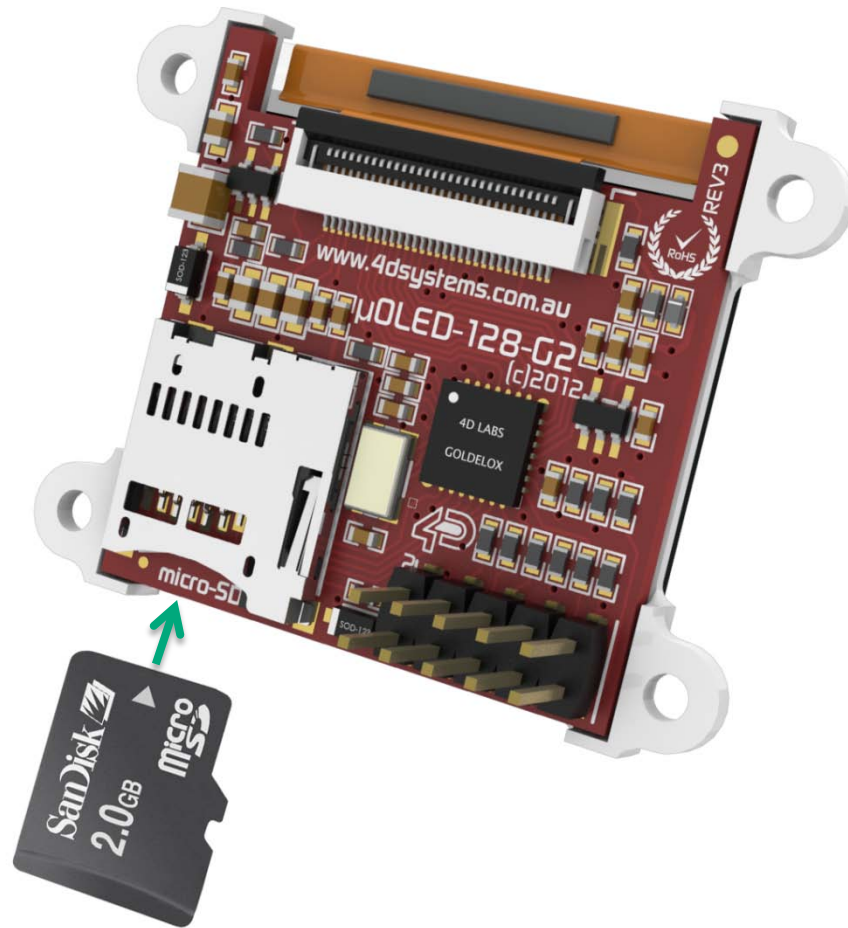



## 6. Powering Your Device

Powering the **μOLED-128-G2** is as simple as connecting to a PC via a 4D Programming Cable.

Alternatively, power can be supplied by a regulated 5V DC source.

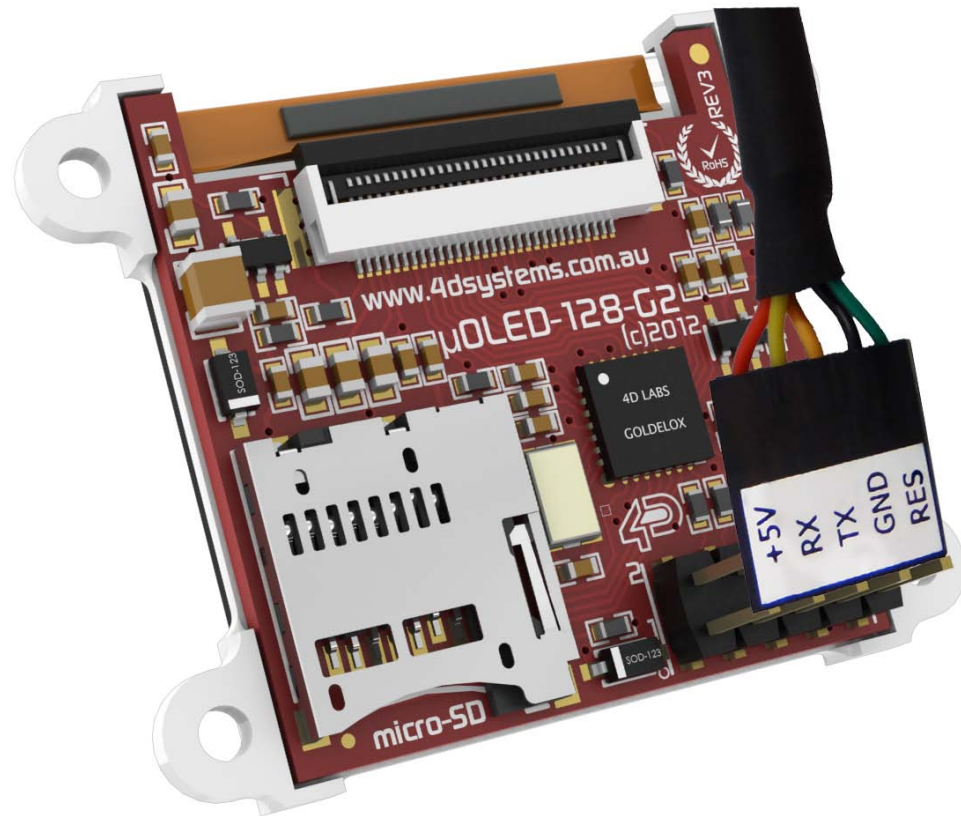

# 7. What you Need

## Essential items



4D Programming Cable



Windows Based PC

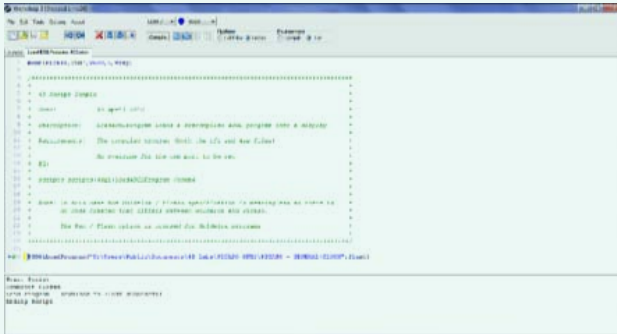

4D Workshop4 IDE Software Tool

## Optional Items



micro-SD Card & SD Adaptor

# 8. Development Environment

**Workshop4** is a comprehensive software IDE tool suite that provides an integrated software development platform for all of the 4D family of processors and modules. The Workshop4 IDE supports three different **Development Environments** for the user, to cater for different requirements and skill level.



**Designer:** The Designer environment enables the user to write 4DGL code in its natural form to program the  $\mu$ OLED-128-G2.



**ViSi:** A visual programming experience, suitably called ViSi, enables drag-and-drop type placement of objects to assist with 4DGL code generation and allows the user to visualise how the display will look while being developed.



**Serial:** A Serial environment is also provided to transform the  $\mu$ OLED-128-G2 into a slave serial module, allowing the user to control the display from any host microcontroller or device with a serial port.

# 9. Getting Started

Getting started is as simple as connecting the 4D Programming Cable to the Display Module, and choosing your Product and Development Environment in the 4D Workshop4 IDE.

4D Workshop4 IDE guides you through the relevant Aid Tools with adequate explanation to get your Application up and running in no time.

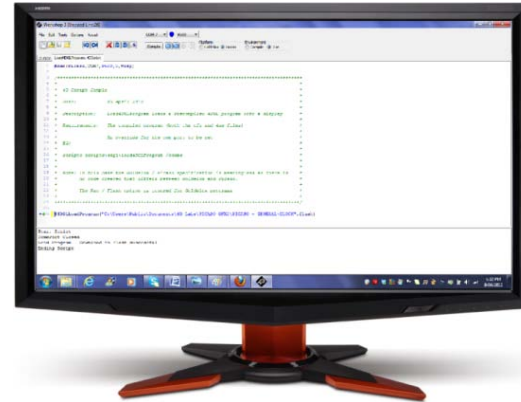
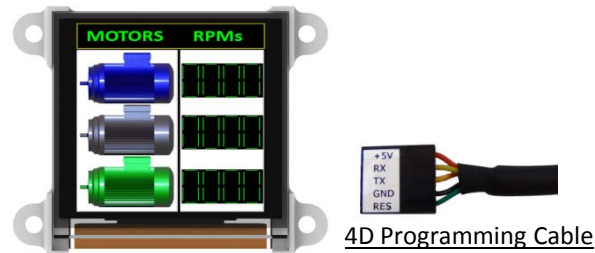

# 10. Mechanical Dimensions

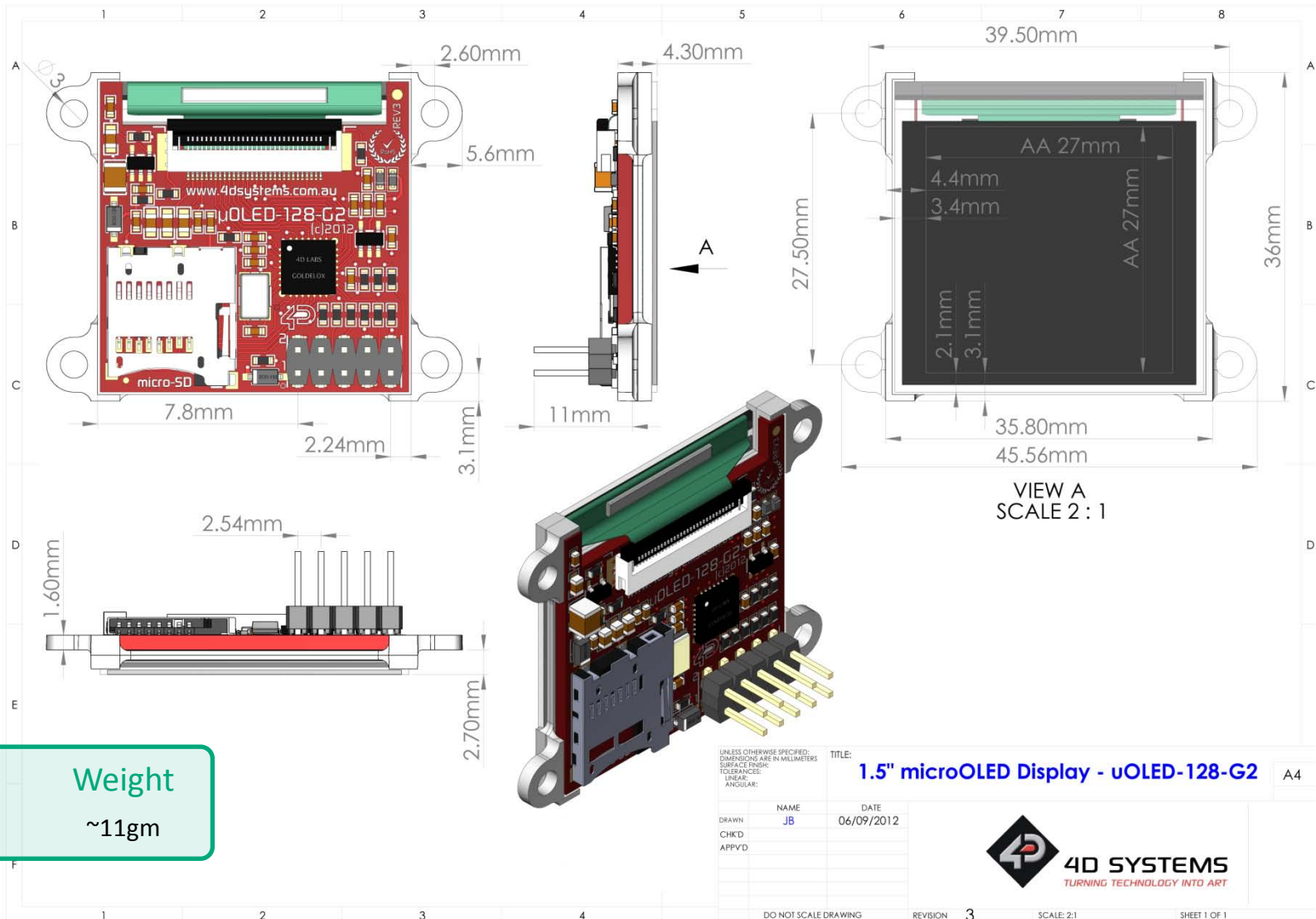

## Proprietary Information

The information contained in this document is the property of 4D Systems Pty. Ltd. and may be the subject of patents pending or granted, and must not be copied or disclosed without prior written permission.

4D Systems endeavours to ensure that the information in this document is correct and fairly stated but does not accept liability for any error or omission. The development of 4D Systems products and services is continuous and published information may not be up to date. It is important to check the current position with 4D Systems. 4D Systems reserves the right to modify, update or make changes to Specifications or written material without prior notice at any time.

All trademarks belong to their respective owners and are recognised and acknowledged.

## Disclaimer of Warranties & Limitation of Liability

4D Systems makes no warranty, either express or implied with respect to any product, and specifically disclaims all other warranties, including, without limitation, warranties for merchantability, non-infringement and fitness for any particular purpose. Information contained in this publication regarding device applications and the like is provided only for your convenience and may be superseded by updates. It is your responsibility to ensure that your application meets with your specifications.

In no event shall 4D Systems be liable to the buyer or to any third party for any indirect, incidental, special, consequential, punitive or exemplary damages (including without limitation lost profits, lost savings, or loss of business opportunity) arising out of or relating to any product or service provided or to be provided by 4D Systems, or the use or inability to use the same, even if 4D Systems has been advised of the possibility of such damages.

4D Systems products are not fault tolerant nor designed, manufactured or intended for use or resale as on line control equipment in hazardous environments requiring fail – safe performance, such as in the operation of nuclear facilities, aircraft navigation or communication systems, air traffic control, direct life support machines or weapons systems in which the failure of the product could lead directly to death, personal injury or severe physical or environmental damage ('High Risk Activities'). 4D Systems and its suppliers specifically disclaim any expressed or implied warranty of fitness for High Risk Activities.

Use of 4D Systems' products and devices in 'High Risk Activities' and in any other application is entirely at the buyer's risk, and the buyer agrees to defend, indemnify and hold harmless 4D Systems from any and all damages, claims, suits, or expenses resulting from such use. No licenses are conveyed, implicitly or otherwise, under any 4D Systems intellectual property rights.



For additional information on the  $\mu$ OLED-128-G2, please refer to the  $\mu$ OLED-128-G2 Datasheet or visit 4D Systems website at [www.4dsystems.com.au](http://www.4dsystems.com.au)

If you require specific help with a 4D Systems product, information can be sourced from the FAQ and relevant forum threads on the website, or by contacting a direct member of our Tech Support team at 4D Systems at [support@4dsystems.com.au](mailto:support@4dsystems.com.au)

For enquiries regarding sales, distributors, or business relations, please contact Sales at [sales@4dsystems.com.au](mailto:sales@4dsystems.com.au)