



User Manual

SOM-7569

COM Express Mini Module

ADVANTECH

Enabling an Intelligent Planet

Copyright

The documentation and the software included with this product are copyrighted 2017 by Advantech Co., Ltd. All rights are reserved. Advantech Co., Ltd. reserves the right to make improvements in the products described in this manual at any time without notice. No part of this manual may be reproduced, copied, translated or transmitted in any form or by any means without the prior written permission of Advantech Co., Ltd. Information provided in this manual is intended to be accurate and reliable. However, Advantech Co., Ltd. assumes no responsibility for its use, nor for any infringements of the rights of third parties, which may result from its use.

Acknowledgements

Intel® is a trademark of Intel® Corporation.

AMI is a trademark of American Megatrends, Inc.

IBM, PC, PS/2 and VGA are trademarks of International Business Machines Corporation.

Microsoft Windows®, DirectX® is a registered trademark of Microsoft Corp.

All other product names or trademarks are properties of their respective owners.

For more information on this and other Advantech products, please visit our websites at:

<http://www.advantech.com>

<http://www.advantech.com/eplatform>

For technical support and service, please visit our support website at:

<http://support.advantech.com/>

Product Warranty (2 years)

Advantech warrants to you, the original purchaser, that each of its products will be free from defects in materials and workmanship for two years from the date of purchase.

This warranty does not apply to any products which have been repaired or altered by persons other than repair personnel authorized by Advantech, or which have been subject to misuse, abuse, accident or improper installation. Advantech assumes no liability under the terms of this warranty as a consequence of such events.

Because of Advantech's high quality-control standards and rigorous testing, most of our customers never need to use our repair service. If an Advantech product is defective, it will be repaired or replaced at no charge during the warranty period. For out-of-warranty repairs, you will be billed according to the cost of replacement materials, service time and freight. Please consult your dealer for more details.

If you think you have a defective product, follow these steps:

1. Collect all the information about the problem encountered. (For example, CPU speed, Advantech products used, other hardware and software used, etc.) Note anything abnormal and list any onscreen messages you get when the problem occurs.
2. Call your dealer and describe the problem. Please have your manual, product, and any helpful information readily available.
3. If your product is diagnosed as defective, obtain an RMA (return merchandise authorization) number from your dealer. This allows us to process your return more quickly.
4. Carefully pack the defective product, a fully-completed Repair and Replacement Order Card and a photocopy proof of purchase date (such as your sales receipt) in a shippable container. A product returned without proof of the purchase date is not eligible for warranty service.
5. Write the RMA number visibly on the outside of the package and ship it prepaid to your dealer.

Declaration of Conformity

CE

This product has passed the CE test for environmental specifications. Test conditions for passing included the equipment being operated within an industrial enclosure. In order to protect the product from being damaged by ESD (Electrostatic Discharge) and EMI leakage, we strongly recommend the use of CE-compliant industrial enclosure products.

FCC Class B

Note: This equipment has been tested and found to comply with the limits for a Class B digital device, pursuant to part 15 of the FCC Rules. These limits are designed to provide reasonable protection against harmful interference in a residential installation. This equipment generates, uses and can radiate radio frequency energy and, if not installed and used in accordance with the instructions, may cause harmful interference to radio communications. However, there is no guarantee that interference will not occur in a particular installation. If this equipment does cause harmful interference to radio or television reception, which can be determined by turning the equipment off and on, the user is encouraged to try to correct the interference by one or more of the following measures:

- Reorient or relocate the receiving antenna.
- Increase the separation between the equipment and receiver.
- Connect the equipment into an outlet on a circuit different from that to which the receiver is connected.
- Consult the dealer or an experienced radio/TV technician for help.

FM

This equipment has passed the FM certification. According to the National Fire Protection Association, work sites are classified into different classes, divisions and groups, based on hazard considerations. This equipment is compliant with the specifications of Class I, Division 2, Groups A, B, C and D indoor hazards.

Technical Support and Assistance

1. Visit the Advantech website at <http://support.advantech.com> where you can find the latest information about the product.
2. Contact your distributor, sales representative, or Advantech's customer service center for technical support if you need additional assistance. Please have the following information ready before you call:
 - Product name and serial number
 - Description of your peripheral attachments
 - Description of your software (operating system, version, application software, etc.)
 - A complete description of the problem
 - The exact wording of any error messages

Warnings, Cautions, and Notes

Warning! Warnings indicate conditions that if not observed can result in personal injury!



Caution! Cautions are included to prevent hardware damage or data losses.



New batteries are at risk of exploding if incorrectly installed. Do not attempt to recharge, force open, or heat the battery. Replace the battery only with the same or equivalent type recommended by the manufacturer. Discard used batteries according to the manufacturer's instructions.

Note! Notes provide additional optional information.



Document Feedback

To assist us in making improvements to this manual, we would welcome comments and constructive criticism. Please send all such - in writing to: support@advantech.com

Packing List

Before setting up the system, check that the items listed below are included and in good condition. If any item does not accord with the table, please contact your dealer immediately.

- SOM-7569 CPU Module
- 1960079608T000 Heatspreader for N4200, N3350 CPU SKU
- 1960079610T000 Heatspreader for E3950, E3940, E3930 CPU SKU

Safety Instructions

1. Read these safety instructions carefully.
2. Keep this User Manual for later reference.
3. Disconnect this equipment from any AC outlet before cleaning. Use a damp cloth. Do not use liquid or spray detergents for cleaning.
4. For plug-in equipment, the power outlet socket must be located near the equipment and must be easily accessible.
5. Keep this equipment away from humidity.
6. Put this equipment on a reliable surface during installation. Dropping it or letting it fall may cause damage.
7. The openings on the enclosure are for air convection. Protect the equipment from overheating. **DO NOT COVER THE OPENINGS.**
8. Make sure the voltage of the power source is correct before connecting the equipment to the power outlet.
9. Position the power cord so that people cannot step on it. Do not place anything over the power cord.
10. All cautions and warnings on the equipment should be noted.
11. If the equipment is not used for a long time, disconnect it from the power source to avoid damage by transient overvoltage.
12. Never pour any liquid into an opening. This may cause fire or electrical shock.
13. Never open the equipment. For safety reasons, the equipment should be opened only by qualified service personnel.
14. If one of the following situations arises, get the equipment checked by service personnel:
 - The power cord or plug is damaged.
 - Liquid has penetrated into the equipment.
 - The equipment has been exposed to moisture.
 - The equipment does not work well, or you cannot get it to work according to the user's manual.
 - The equipment has been dropped and damaged.
 - The equipment has obvious signs of breakage.
15. **DO NOT LEAVE THIS EQUIPMENT IN AN ENVIRONMENT WHERE THE STORAGE TEMPERATURE MAY GO BELOW -20° C (-4° F) OR ABOVE 60° C (140° F). THIS COULD DAMAGE THE EQUIPMENT. THE EQUIPMENT SHOULD BE IN A CONTROLLED ENVIRONMENT.**
16. **CAUTION: DANGER OF EXPLOSION IF BATTERY IS INCORRECTLY REPLACED. REPLACE ONLY WITH THE SAME OR EQUIVALENT TYPE RECOMMENDED BY THE MANUFACTURER, DISCARD USED BATTERIES ACCORDING TO THE MANUFACTURER'S INSTRUCTIONS.**

The sound pressure level at the operator's position according to IEC 704-1:1982 is no more than 70 dB (A).

DISCLAIMER: This set of instructions is given according to IEC 704-1. Advantech disclaims all responsibility for the accuracy of any statements contained herein.

Safety Precaution - Static Electricity

Follow these simple precautions to protect yourself from harm and the products from damage.

- To avoid electrical shock, always disconnect the power from your PC chassis before you work on it. Don't touch any components on the CPU card or other cards while the PC is on.
- Disconnect power before making any configuration changes. The sudden rush of power as you connect a jumper or install a card may damage sensitive electronic components.

Contents

Chapter 1	General Information	1
1.1	Introduction	2
	Table 1.1: Acronyms.....	3
1.2	Functional Block Diagram	4
1.3	Product Specification	5
	Table 1.2: Feature List.....	5
	Table 1.3: Processor System	6
	Table 1.4: Graphics	7
	Table 1.5: Display Interface.....	7
	Table 1.6: Multiple-Display	8
Chapter 2	Mechanical Information	13
2.1	Board Information.....	14
	Figure 2.1 Board chips identify - Front.....	14
	Figure 2.2 Board chips identify - Front.....	14
	Figure 2.3 Board chips identify – Back	15
2.2	Mechanical Drawing.....	15
	Figure 2.4 Board Mechanical Drawing - Front	15
	Figure 2.5 Board Mechanical Drawing - Front	16
	Figure 2.6 Board Mechanical Drawing – Back.....	16
	Figure 2.7 Board Mechanical Drawing – Side	17
2.3	Assembly Drawing	17
	Figure 2.8 Assembly Drawing.....	17
	Figure 2.9 Main Chip Height and Tolerance	18
	Figure 2.10Main Chip Height and Tolerance	18
Chapter 3	AMI BIOS	19
	Figure 3.1 Setup program initial screen.....	20
3.1	Entering Setup	20
3.2	Main Setup	20
	Figure 3.2 Main setup screen	21
3.3	Advanced BIOS Features Setup	22
	Figure 3.3 Advanced BIOS features setup screen	22
3.3.1	Trusted Computing	23
	Figure 3.4 ACPI Settings	23
3.3.2	ACPI Settings.....	24
	Figure 3.5 ACPI Settings	24
3.3.3	Embedded Controller	25
	Figure 3.6 Embedded Controller.....	25
3.3.4	Serial Port 1 Configuration.....	26
	Figure 3.7 Serial Port 1 Configuration	26
3.3.5	Serial Port 2 Configuration.....	27
	Figure 3.8 Serial Port 2 Configuration	27
3.3.6	Hardware Monitor	28
	Figure 3.9 Hardware Monitor	28
3.4	W83627DHGSEC Super IO Configuration.....	29
	Figure 3.10W83627DHGSEC Super IO Configuration	29
3.4.1	Serial Port 3 Configuration.....	30
	Figure 3.11Serial Port 3 Configuration	30
3.4.2	Serial Port 4 Configuration.....	31
	Figure 3.12Serial Port 4 Configuration	31

3.4.3	Parallel Port Configuration.....	32
	Figure 3.13Parallel Port Configuration	32
3.4.4	Serial Port Console Redirection.....	33
	Figure 3.14Serial Port Console Redirection	33
	Figure 3.15Legacy Console Redirection Settings	34
3.4.5	CPU Configuration.....	35
	Figure 3.16CPU Configuration	35
3.4.6	Socket 0 CPU Configuration.....	36
	Figure 3.17Socket 0 CPU Configurations.....	36
3.4.7	CPU Power Management.....	37
	Figure 3.18Socket 0 CPU Configurations.....	37
3.4.8	Network Stack Configuration	38
	Figure 3.19Network Stack Configuration	38
3.4.9	CSM Configuration	39
	Figure 3.20CSM Configuration	39
3.4.10	NVMe Configuration	40
	Figure 3.21NVMe Configuration	40
3.4.11	SDIO Configuration.....	41
	Figure 3.22SDIO Configuration	41
3.4.12	USB Configuration	42
	Figure 3.23USB Configuration.....	42
3.4.13	Platform Trust Technology.....	43
	Figure 3.24Platform Trust Technology	43
3.4.14	Security Configuration	44
	Figure 3.25Security Configuration	44
3.5	Chipset.....	45
	Figure 3.26Chipset Setup.....	45
3.5.1	North Bridge.....	46
	Figure 3.27North Bridge	46
3.5.2	South Bridge	47
	Figure 3.28South Bridge.....	47
3.5.3	Uncore Configuration.....	48
	Figure 3.29Uncore Configuration	48
3.5.4	South Cluster Configuration.....	49
	Figure 3.30South Cluster Configuration	49
	Figure 3.31HD-Audio Configuration	50
	Figure 3.32PCI Express Configuration	51
	Figure 3.33LAN	53
	Figure 3.34PCI Express Root Port 0 Configuration.....	54
	Figure 3.35PCI Express Root Port 1 Configuration.....	55
	Figure 3.36PCI Express Root Port 2 Configuration.....	56
	Figure 3.37PCI Express Root Port 3 Configuration.....	57
	Figure 3.38SATA Drives.....	58
	Figure 3.39SCC Configuration	59
	Figure 3.40USB Configuration.....	60
	Figure 3.41Miscellaneous Configuration	61
3.6	Security Setting.....	62
	Figure 3.42Security Setup.....	62
3.7	Boot Settings.....	63
	Figure 3.43Boot Setting.....	63
3.8	Save & Exit	64
	Figure 3.44Save & Exit.....	64

Chapter 4 S/W Introduction & Installation..... 65

4.1	S/W Introduction	66
4.2	Driver Installation	66
4.2.1	Windows Driver Setup	66
4.2.2	Other OS.....	66

4.3	Advantech iManager	66
-----	--------------------------	----

Appendix A Pin Assignments69

A.1	SOM-7569 Type 10 Pin Assignment.....	70
	Table A.1: SOM-7569 Row A,B	70

Appendix B Watchdog Timer73

B.1	Programming the Watchdog Timer	74
-----	--------------------------------------	----

Appendix C Programming GPIO75

C.1	GPIO Register.....	76
-----	--------------------	----

Appendix D System Assignments77

D.1	System I/O Ports	78
	Table D.1: System I/O ports.....	78
D.2	Interrupt Assignments	80
	Table D.2: Interrupt Assignments.....	80
D.3	1st MB Memory Map	81
	Table D.3: 1st MB Memory Map	81

Chapter 1

General Information

This chapter gives background information on the SOM-7569 COM Express Mini CPU Module.

Sections include:

- Introduction
- Functional Block Diagram
- Product Specification

1.1 Introduction

SOM-7569 is a COM Express Mini module with type 10 pin-out that fully complies with the PICMG (PCI Industrial Computer Manufactures Group) COM.0 R2.1 specification. SOM-7569 is a new, low power CPU module, equipped with the latest Intel® Atom™ E3900 & Pentium™ and Celeron™ N Series Processors single-chip processors, which are manufactured on new 14-nm process technology. SOM-7569 supports up to 8GB single channel DDR3L 1866(non-ECC)/1600(ECC) MT/s onboard memory, with higher memory bandwidth for better performance. In addition, this mini module supports eMMC onboard storage; it is suitable for lower power or handheld applications such for digital signage, medical, automation and transportation.

SOM-7569 features low power Intel® Gen 9-Low power graphics and HEVC, H.264, MVC, VP8, VP9, JPEG/MJPEG media encode & decode engine and MPEG2, VC-1, WMV9 decode, with up to 18 Execution Units. SOM-7569 supports 3-D rendering, media compositing, and video encoding and includes the latest DX, OpenGL 4.3, OGL ES 3.0, OpenCL 1.2 function. In addition, this mini module provides multiple display interfaces—one channel LVDS or eDP, and HDMI/DisplayPorts, which are able to support dual displays. This product is designed to support wide-range voltage input from 4.75 to 20V; this provides flexible options to fulfill various application requirements. SOM-7569 adopts a rich array of I/O interfaces including 4 PCIe x1 for better data transmission, and offers one Intel® i210IT/i210AT LAN controller, 2 SATA Gen3, 8 USB 2.0, 2 USB3.0, 2 COM ports, SMBus, I2C, and HD audio interface functions.

Advantech iManager was designed to satisfy a lot of embedded application requirements such as multi-level watchdog timer, voltage and temperature monitoring, and thermal protection through processor throttling, as well as LCD backlight on/off, brightness control, and embedded storage information. Combined with Advantech SUSI Access, it can remotely monitor and control devices via the internet for easy maintenance. All Advantech COM Express modules integrate iManager and SUSI Access to benefit customer's applications.

Table 1.1: Acronyms

Term	Define
AC'97	Audio CODEC (Coder-Decoder)
ACPI	Advanced Configuration Power Interface – standard to implement power saving modes in PC-AT systems
BIOS	Basic Input Output System – firmware in PC-AT system that is used to initialize system components before handing control over to the operating system
CAN	Controller-area network (CAN or CAN-bus) is a vehicle bus standard designed to allow microcontrollers to communicate with each other within a vehicle without a host computer
DDI	Digital Display Interface – containing DisplayPort, HDMI/DVI, and SDVO
EAPI	Embedded Application Programmable Interface <ul style="list-style-type: none"> ■ Software interface for COM Express® specific industrial function ■ System information ■ Watchdog timer ■ I2C Bus ■ Flat Panel brightness control ■ User storage area ■ GPIO
GbE	Gigabit Ethernet
GPIO	General purpose input output
HDA	Intel High Definition Audio (HD Audio) refers to the specification released by Intel in 2004 for delivering high definition audio that is capable of playing back more channels at higher quality than AC'97
I2C	Inter Integrated Circuit – 2 wire (clock and data) signaling scheme allowing communication between integrated circuit, primarily used to read and load register values
ME	Management Engine
PC-AT	“Personal Computer – Advanced Technology” – an IBM trademark term used to refer to Intel based personal computer in 1990s
PEG	PCI Express Graphics
RTC	Real Time Clock – battery backed circuit in PC-AT systems that keeps system time and date as well as certain system setup parameters
SPD	Serial Presence Detect – refers to serial EEPROM on DRAMs that has DRAM Module configuration information
TPM	Trusted Platform Module, chip to enhance the security features of a computer system
UEFI	Unified Extensible Firmware Interface
WDT	Watch Dog Timer

1.2 Functional Block Diagram

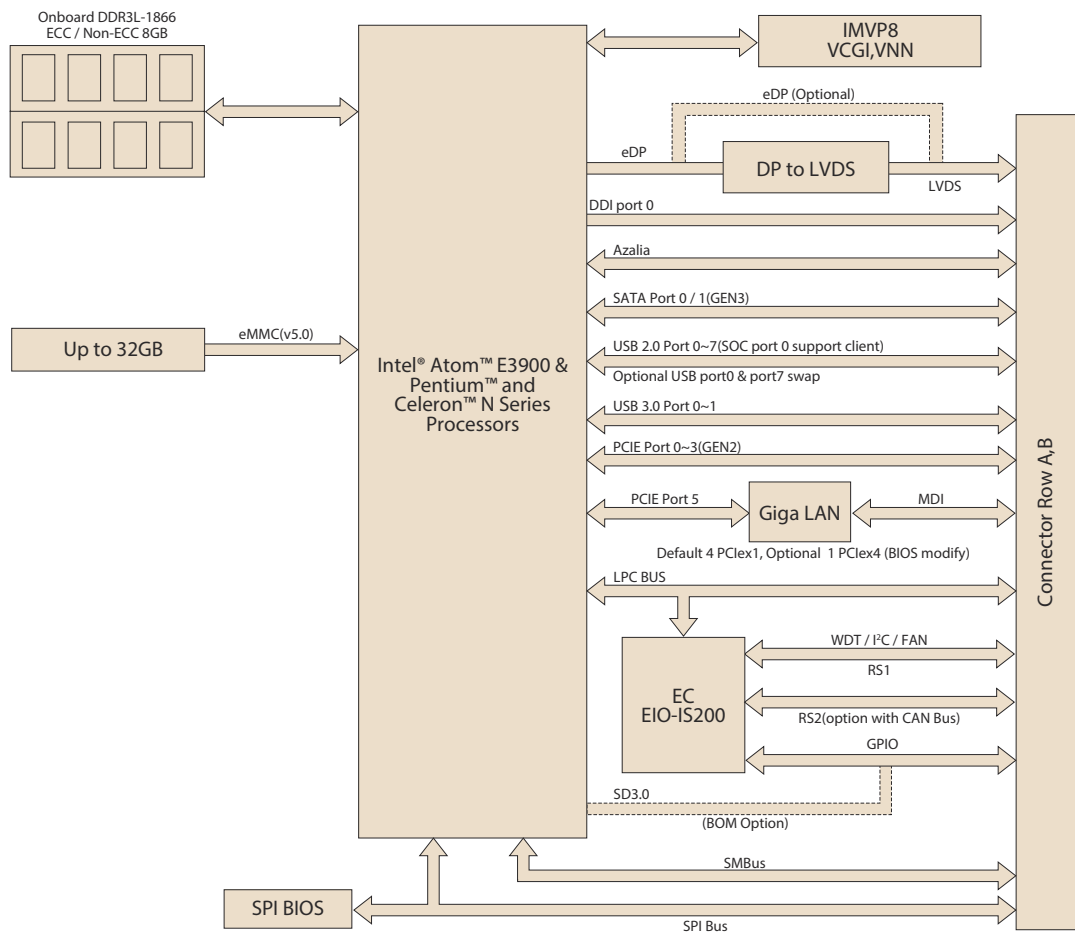

1.3 Product Specification

Compliance

- COM R.2.1 Type 10 Mini Module
- 84 x 55 mm

Feature List

Table 1.2: Feature List			
A-B	System I/O	Rev.2.1 Type 10	SOM-7569 R2.1 Type 10
	PCI Express Lanes 0 - 5	1 / 4	3/4
	LVDS Channel A	0 / 1	1
	LVDS Channel B	N/A	N/A
	eDP on LVDS CH A Pins	0 / 1	1 (Option)
	VGA Port	N/A	N/A
	TV-Out	N/A	N/A
	Digital Display Interface 0	0 / 1	1
	Serial Ports 1 - 2 **	0 / 2	2
	CAN Interfaces on SER1	0 / 1	1 (Option)
	SATA / SAS Ports	1 / 2	2
	AC'97 / HDA Digital Interface	0 / 1	1
	USB 2.0 Ports (Host)	4 / 8	8
	USB Client (USB2.0)	0 / 1	1 (Option)
	USB 3.0 Ports (Host)	0 / 2	2
	LAN Port 0	1 / 1	1
	Express Card Support	0 / 2	2
	LPC Bus	1 / 1	1
	SPI	1 / 2	1
A-B	System Management	Rev.2.1 Type 10	SOM-7569 R2.1 Type 10
	SDIO (Muxed on GPIO)	0 / 1	1 (Option)
	General Purpose I/O	8 / 8	8
	SMBus	1 / 1	1
	I2C	1 / 1	1
	Watchdog Timer	0 / 1	1
	Speaker Out	1 / 1	1
	External BIOS ROM Support	0 / 2	2
	Reset Function	1 / 1	1
A-B	Power Management	Rev.2.1 Type 10	SOM-7569 R2.1 Type 10
	Thermal Protection	0 / 1	1
	Battery Low Alarm	0 / 1	1
	Suspend / Wake Signals	0 / 3	3
	Power Button Support	1 / 1	1
	Power Good	1 / 1	1
	VCC_5V_SBY Contacts	4 / 4	4

Table 1.2: Feature List

	Sleep	0 / 1	1
	Lid Input	0 / 1	1
	Fan PWM / Tachometer **	0 / 2	2
	Trusted Platform Modules	0 / 1	1
A-B	Power	Rev.2.1 Type 10	SOM-7569 R2.1 Type 10
	VCC_12V Contacts	12 / 12	12
C-D	System I/O	Rev.2.1 Type 10	SOM-7569 R2.1 Type 10
	PCI Express Lanes 16 - 31	N/A	N/A
	PCI Express Graphics (PEG)	N/A	N/A
	Muxed SDVO Channels 1 - 2	N/A	N/A
	PCI Express Lanes 6 - 15	N/A	N/A
	PCI Bus - 32 Bit	N/A	N/A
	PATA Port	N/A	N/A
	LAN Port 1 - 2	N/A	N/A
	Digital Display Interfaces 1 - 3	N/A	N/A
	USB 3.0 Ports	N/A	N/A
C-D	Power	Rev.2.1 Type 10	SOM-7569 R2.1 Type 10
	VCC_12V Contacts	N/A	N/A

Processor System**Table 1.3: Processor System**

CPU	Std. Freq.	Max. Turbo Freq.	Core/Threat	LLC Cache	TDP(W)
Atom X7-E3950	1.6 GHz	2 GHz	4/4	2MB	12W
Atom X5-E3940	1.6 GHz	1.8 GHz	4/4	2MB	9.5W
Atom X5-E3930	1.3 GHz	1.8 GHz	2/2	2MB	6.5W
Pentium N4200	1.1 GHz	2.5 GHz	4/4	2MB	6W
Celeron N3350	1.1 GHz	2.4 GHz	2/2	2MB	6W

Memory

One channel DDR3L 1866 ECC / non-ECC onboard memory up to 8 GB.

Graphics

Intel Gen9-LP graphics supports up to 18 EUs (execution unit).

Table 1.4: Graphics

CPU	Graphics Controller	Base Freq.	Max. Burst Freq.	GfX EUs
Atom X7-E3950	Intel HD Graphics 505	500 MHz	650 MHz	18
Atom X5-E3940	Intel HD Graphics 500	400 MHz	600 MHz	12
Atom X5-E3930	Intel HD Graphics 500	400 MHz	550 MHz	12
Pentium N4200	Intel HD Graphics 505	200 MHz	750 MHz	18
Celeron N3350	Intel HD Graphics 500	200 MHz	650 MHz	12

- **3D API support**
DirectX (9.3, 10, 11.1, 12), OpenGL 4.3, OGL ES 3.0
- **Other API support**
OpenCL 1.2
- **Media Hardware Decoder**
HEVC (H.265) @L5, H.264 @5.2, MVC, MPEG2, VP8, VP9, VC-1, WMV9, JPEG/MJPEG
- **Media Hardware Encoder**
HEVC (H.265) @L4, H.264@ 5.2, MVC, VP8, VP9, JPEG/MJPEG
- **Media Content Protection**
PAVP, HDCP 2.2, WiDi, Play Ready3 DRM

Display Interface

Supports single channel 18/24-bit LVDS (optionally can be eDP). Supports DDI0 with configurable DisplayPort (DP), HDMI,DVI.

Table 1.5: Display Interface

	LVDS	eDP	DP	HDMI
# of Ports	Single channel 18/24-bit	1 port shared with LVDS	1 port shared with HDMI	1 port
Standard	ANSI/TIA/EIA-644-A-2001 standard	eDP1.4	DP1.2	HDMI1.4b
Max. Resolution	Up to 1366x768 @ 60Hz Option support eDP1.3	Up to 3840x2160 @ 60 Hz	Up to 4096x2160 @ 60 Hz	Up to 3840x2160 @ 30 Hz
Data Rate		5.4Gb/s	5.4Gb/s	2.9Gb/s
HDCP	N/A	N/A	1.4	1.4
HD Audio	N/A	N/A	Yes	Yes

Multiple-Display

Table 1.6: Multiple-Display

		Single Display	Dual Display	
		LVDS, eDP, DP/ HDMI/DVI	LVDS+DP/HDMI/DVI	eDP+DP/HDMI/DVI
eDP	LVDS	Single channel 18/24-bit, up to 1366 x 768	Single channel 18/24-bit, up to 1366 x 768	-
	eDP	3840x2160 @ 60 Hz	-	3840x2160 @ 60 Hz
DDIO	DP	Up to 4096x2160 @ 60 Hz	Up to 4096x2160 @ 60 Hz	
	HDMI	or Up to 3840x2160 @ 30 Hz	or Up to 3840x2160 @ 30 Hz	
	DVI	1920 x 1080@60Hz	1920 x 1080@60Hz	

Expansion Interface

■ PCIe x1

Intel natively integrates 4 PCI Express x1 lanes.

	PCIe P0	PCIe P1	PCIe P2	PCIe P3	LAN
Default	x1	x1	x1	x1	Yes
Option	x4				Yes

■ HD Audio Interface

Supports Intel HD Audio interface integrated in Intel SoC.

■ LPC

Supports Low Pin Count (LPC) 1.1 specification, without DMA or bus mastering. Allows connection to Super I/O, embedded controller, or TPM. LPC clock is 25MHz.

Serial Bus

■ SMBus

Supports SMBus 2.0 specification with Alert pin.

■ I2C Bus

Supports I2C bus 8-bit and 10-bit address modes, at both 100KHz and 400KHz.

I/O

■ Gigabit Ethernet

On-module Intel i210IT/i210AT supports IEEE802.3 for 1000BASE-T, 100BASE-TX, and 10BASE-T (802.3, 802.3u, and 802.3ab). Supports IPv4, IPv6, TCP/UDP, SCTP, ARP, Neighbor Discovery, EUI-64.

■ SATA

Supports 2 ports SATA Gen3 (6.0 Gb/s), backward compliant to SATA Gen2 (3.0 Gb/s) and Gen1 (1.5 Gb/s). Maximum data rate is 600 MB/s. Supports AHCI 1.3.1 mode (not support IDE mode).

■ USB3.0/USB2.0

2 ports USB3.0 (5.0 Gbps) and 8 ports USB2.0 (480 Mbps) which are backward compatible to USB1.x. For USB3.0, supports LPM (U0, U1, U2, and U3) manageability to saving power.

■ USB3.0

	P0	P1
SoC	P0	P1
Schematics	USB_0_1_OC#	
SoC USB_OC#	USB_OC0#	

■ USB2.0

	P0	P1	P2	P3	P4	P5	P6	P7
SoC	P0	P1	P2	P3	P4	P5	P6	P7
Schematics	USB_0_1_OC#		USB_2_3_OC#		USB_4_5_OC#		USB_6_7_OC#	
SoC USB_OC#	USB_OC0#				USB_OC1#			

■ SPI Bus

Supports BIOS flash only. SPI clock can be 50MHz, 33MHz, or 20MHz, capacity up to 16MB.

■ Watchdog

Supports multi-level watchdog time-out output. Provides 1-65535 levels, from 100ms to 109.22 minutes interval.

■ Serial port

2 ports 2-wire serial port (Tx/Rx) supports 16550 UART compliance.

- Programmable FIFO or character mode
- 16-byte FIFO buffer on transmitter and receiver in FIFO mode
- Programmable serial-interface characteristics: 5, 6, 7, or 8-bit character
- Even, odd, or no parity bit selectable
- 1, 1.5, or 2 stop bit selectable
- Baud rate up to 115.2K

■ BIOS

BIOS chip is on module by default. Allows users to place BIOS chip on carrier board with appropriate design and a pull-down to GND on BIOS_DISABLE# pin.

Note! *If system CMOS is cleared, we strongly suggest to go to BIOS setup menu and load default setting at first time of boot up.*



Power Management

■ Power Supply

Supports both ATX and AT power modes. VSB is for suspend power and can be optional if not required (suspend-to-RAM). RTC Battery may be optional if time/date is not required.

VCC: 5V +/- 5%

VSB: 5V +/- 5% (Suspend power)

RTC Battery Power: 2.0V – 3.3V

■ PWROK

Power OK from main power supply. A high value indicates that the power is good. This signal can be used to hold off Module startup to allow Carrier based FPGAs or other configurable devices time to be programmed.

■ Power Sequence

According to PICMG COM Express COM.0 R 2.1 specification.

■ Wake Event

Various wake-up event support allows the user to apply to different scenarios.

- Wake-on-LAN(WOL): Wake to S0 from S3/S4/S5
- USB Wake: Wake to S0 from S3
- PCIe Device Wake: depends on user inquiry and may need customized BIOS
- LPC Wake: depends on user inquiry and may need customized BIOS

- **Advantech S5 ECO Mode (Deep Sleep Mode)**

Advantech iManager provides additional features to allow the system enter a very low suspend power mode – S5 ECO mode. In this mode, the Module will cut all power including suspend and active power into the chipset and keep an on-module controller active. Therefore, only an under 50mW power will consume which means user battery pack can last longer time. While this mode is enabled in BIOS, the system (or module) will only allow a power button to boot rather than others such as WOL.

Environment

- **Temperature**

Operating: 0 ~ 60° C (32 ~ 140° F), with a fan-less heatsink under 0.7m/s air flow chamber

Storage: -40 ~ 85° C (-40 ~ 185° F)

Extend: -40 ~85 °C (-40 ~ 185 °F)

- **Humidity**

Operating: 40° C @ 95% relative humidity, non-condensing

Storage: 60° C @ 95% relative humidity, non-condensing

- **Vibrations**

IEC60068-2-64: Random vibration test under operation mode, 3.5Grms

- **Drop Test (Shock)**

Federal Standard 101 Method 5007 test procedure with standard packing

- **EMC**

CE EN55022 Class B and FCC Certifications: validate with standard development boards in Advantech chassis

- **MTBF**

Please refer Advantech SOM-7569 Series Reliability Prediction Report No: TBC.

The mission of Advantech Embedded Software Services is to "Enhance quality of life with Advantech platforms and Microsoft Windows embedded technology." We enable Windows Embedded software products on Advantech platforms to more effectively support the embedded computing community. Customers are freed from the hassle of dealing with multiple vendors (Hardware suppliers, System integrators, Embedded OS distributor) for projects. Our goal is to make Windows Embedded Software solutions easily and widely available to the embedded computing community.

To install the drivers, please connect to internet and browse the website <http://support.advantech.com.tw> to download the setup file.

Advantech iManager

Supports APIs for GPIO, smart fan control, multi-stage watchdog timer and output, temperature sensor, hardware monitor, etc. Followed by PICMG EAPI 1.0 specification that provides backward compatibility.

Advantech WISE-PaaS/RMM

Cloud-based centralized remote IPC, IoT device HW & SW status monitoring and management.

Reliable:

Remote monitoring and management for all connected devices with access control Integration of 3rd party protection and recovery solution and support server redundancy for service availability.

Scalable:

Supports up to 1000 IoT device connections.

Supports 3 layers of server hierarchy and unlimited sub-server amount.

Extensible:

Restful API web service, Node-red & WISE Agent framework allow users to make further development, customization, and integration based on their applications.

Power Consumption & Performance

For reference performance or benchmark data that compare with other module, please refer to “Advantech COM Performance & Power Consumption Table”.

Selection Guide w/ P/N:

Part No.	SoC	Base/ Burst Freq.	Core	LLC	CPU TDP	Onboard Mem- ory	Onboard Flash	Thermal Solution	Operating Temperature
SOM-7569CM0C-S2A1E	Pentium N4200	1.1GHz / 2.5GHz	4	2MB	6W	4GB / Non-ECC	N/A	Passive	0~60° C
SOM-7569CM0C-S1A1E	Celeron N3350	1.1GHz / 2.4GHz	2	2MB	6W	4GB / Non-ECC	N/A	Passive	0~60° C
SOM-7569CCBC-S6A1E	Atom X7-E3950	1.6GHz / 2GHz	4	2MB	12W	4GB / ECC	MLC 32GB	Passive	0~60° C
SOM-7569CM0C-S5A1E	Atom X5-E3940	1.6GHz / 1.8GHz	4	2MB	9.5W	4GB / ECC	N/A	Passive	0~60° C
SOM-7569CM0C-S3A1E	Atom X5-E3930	1.3GHz / 1.8GHz	2	2MB	6.5W	4GB / ECC	N/A	Passive	0~60° C
SOM-7569DCBX-S6A1E	Atom X7-E3950	1.6GHz / 2GHz	4	2MB	12W	8GB / ECC	MLC 32GB	TBC	-40 ~ 85° C
SOM-7569CCBX-S6A1E	Atom X7-E3950	1.6GHz / 2GHz	4	2MB	12W	4GB / ECC	MLC 32GB	TBC	-40 ~ 85° C
SOM-7569CM0X-S5A1E	Atom X5-E3940	1.6GHz / 1.8GHz	4	2MB	9.5W	4GB / ECC	N/A	TBC	-40 ~ 85° C
SOM-7569CM0X-S3A1E	Atom X5-E3930	1.3GHz / 1.8GHz	2	2MB	6.5W	4GB / ECC	N/A	TBC	-40 ~ 85° C

Note! Any other SKU or combination is project based support. Please contact sales for details.



Packing list

Part No.	Description	Quantity
-	SOM-7569 CPU Module (N4200, N3350 CPU SKU)	1
1960079608T000	Heatspreader * For N4200, N3350 CPU SKU	1
Part No.	Description	Quantity
-	SOM-7569 CPU Module (E3950, E3940, E3930 CPU SKU)	1
1960079610T000	Heatspreader * For E3950, E3940, E3930 CPU SKU	1

Development Board

Part No.	Description
SOM-DB5800-U0A2E	COMe Devel. Board Type10 pint-out Rev. A2

Accessory

Part No.	Description
1960056280N001	Semi-Heatsink 84L x 55W x 13.2H mm (0 ~ 60° C)
96LEDK-I057VG50NA1	5.7" LED PANEL 500N 640X480(G)
96LEDK-A084SV45NB2	8.4" LED PANEL 450N 800X600(G) G084SN05 V9
96LEDK-C150XG40NG1	15" LED PANEL 400N 1024X768(G) G150XGE-L04

Pin Description

Advantech provides useful checklists for schematic design and layout routing. In schematic checklist, it will specify detail about each pin electrical properties and how to connect for different user scenes. In layout checklist, it will specify the layout constraints and recommendations for trace length, impedance, and other necessary information during design.

Please contact your nearest Advantech branch office or call for getting the design documents and further advance supports.

Chapter 2

Mechanical Information

This chapter gives mechanical information on the SOM-7569 COM Express Mini CPU Module.

Sections include:

- Board Information
- Mechanical Drawing
- Assembly Drawing

2.1 Board Information

The figures below indicate the main chips on SOM-7569 COM Express Mini CPU Module.

Please aware on these positions while designing the customer's own carrier board to avoid mechanical problems and for thermal solutions contacts for best thermal dissipation performance.

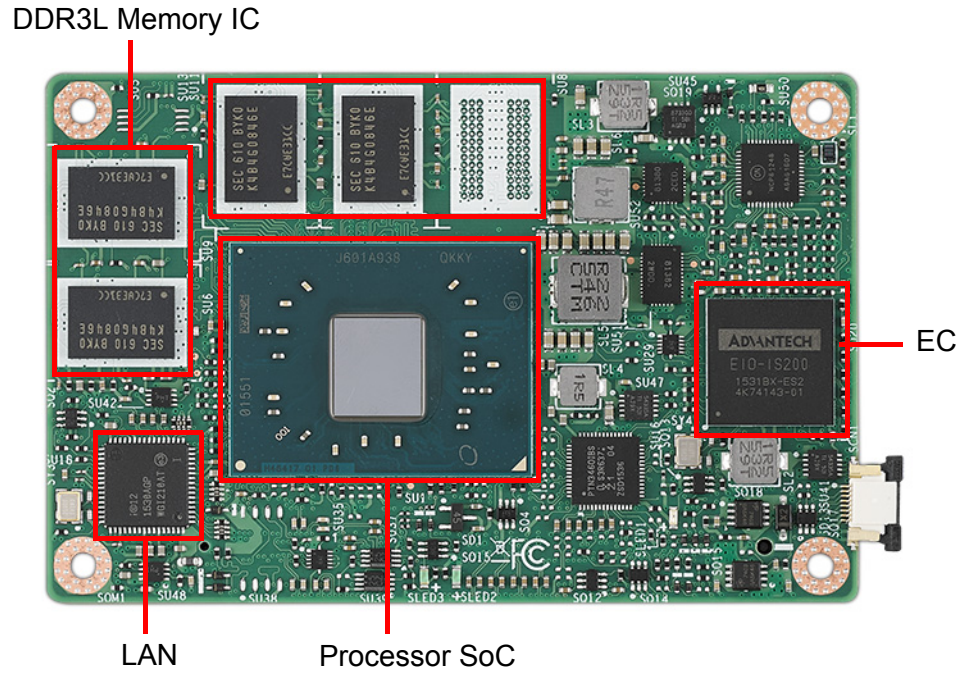

Intel® Pentium and Celeron N and J Series
Figure 2.1 Board chips identify - Front

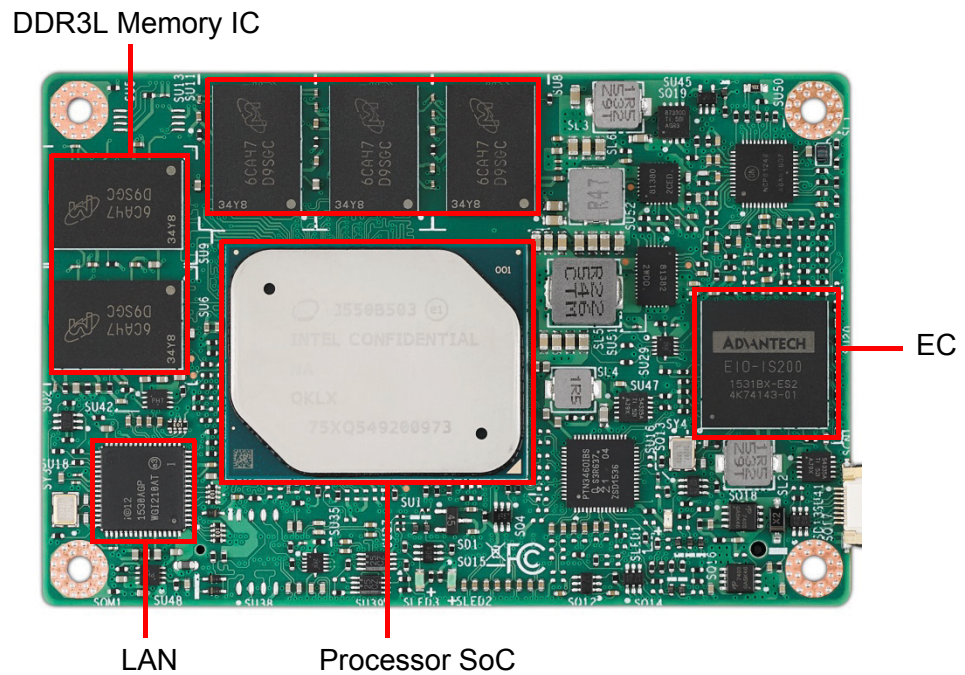

Intel® Atom™ Processor E3900 Series
Figure 2.2 Board chips identify - Front

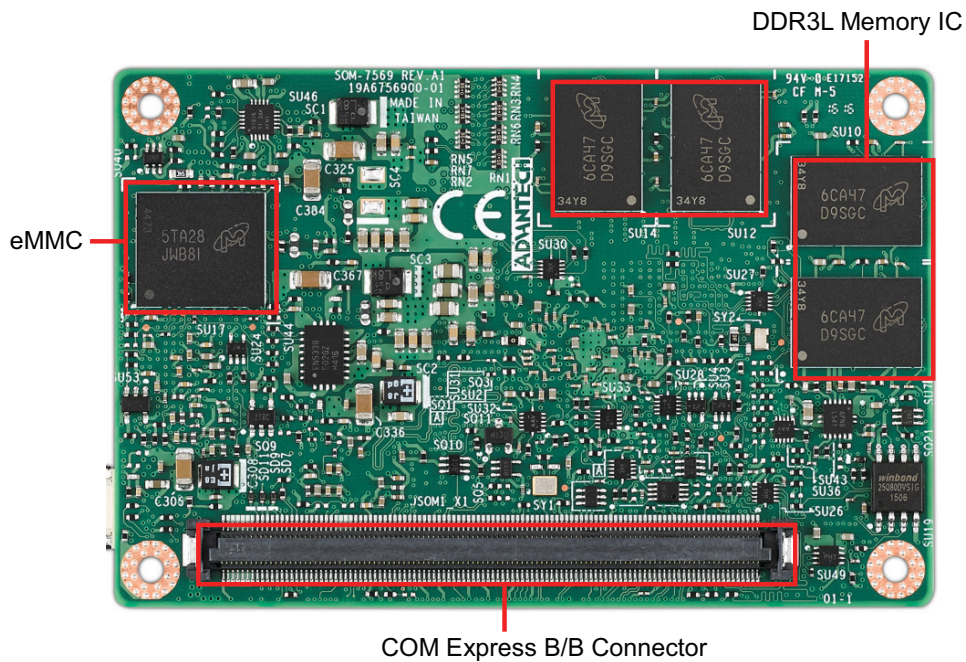
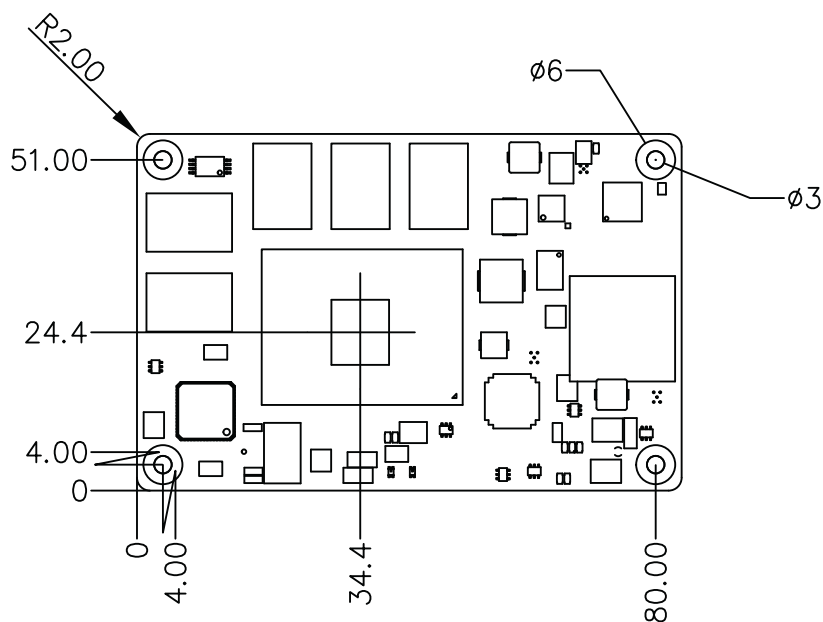

Figure 2.3 Board chips identify – Back

2.2 Mechanical Drawing

For more details about 2D/3D models, please look on Advantech’s COM support service website:

<http://com.advantech.com>.



Intel® Pentium and Celeron N and J Series
Figure 2.4 Board Mechanical Drawing - Front

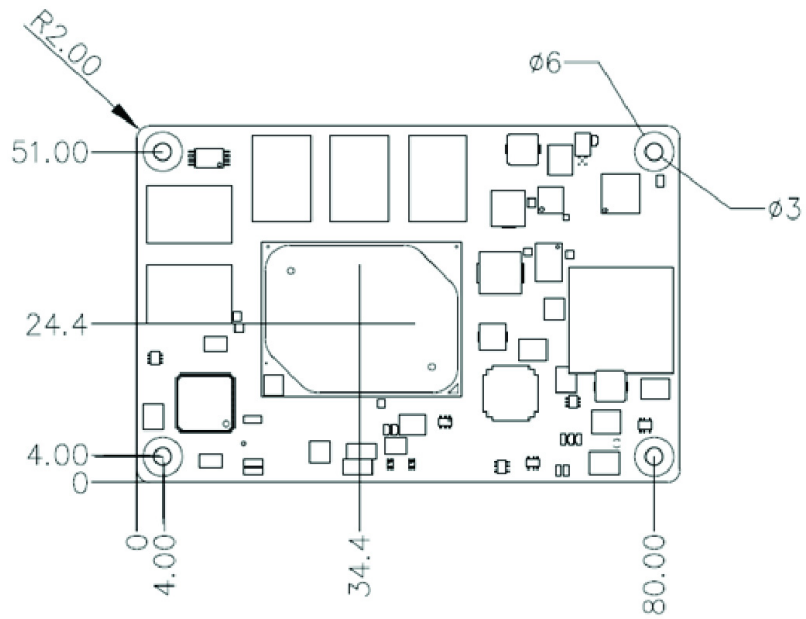

Intel® Atom™ Processor E3900 Series
Figure 2.5 Board Mechanical Drawing - Front

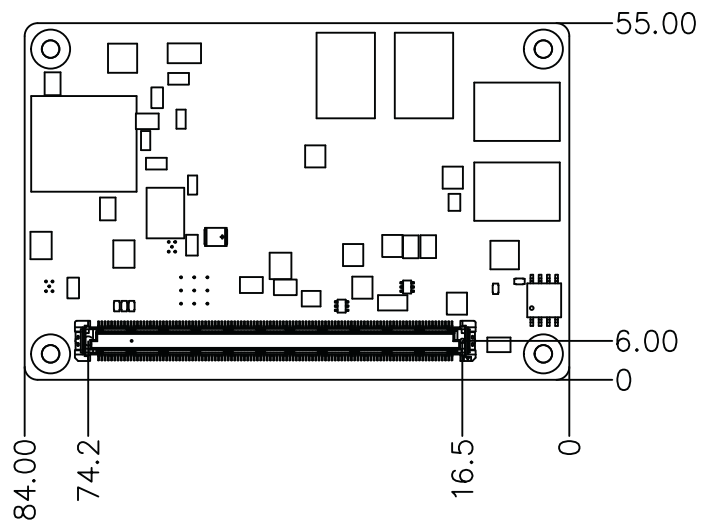

Figure 2.6 Board Mechanical Drawing – Back

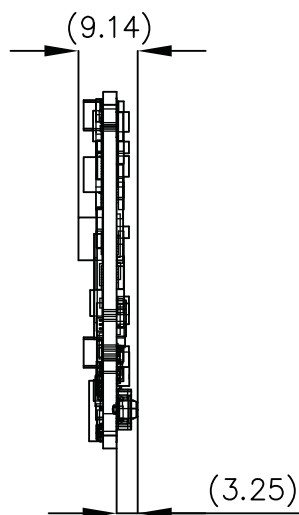

Figure 2.7 Board Mechanical Drawing – Side

2.3 Assembly Drawing

These figures demonstrate the assembly order from thermal module, COM Express CPU module to carrier board.

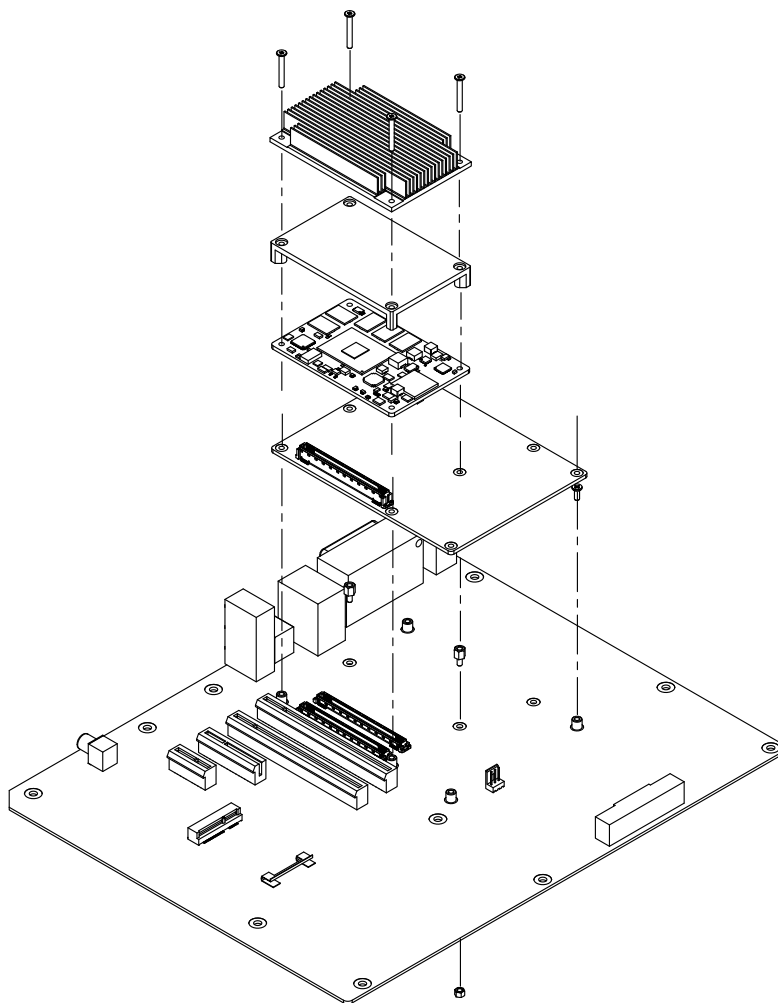
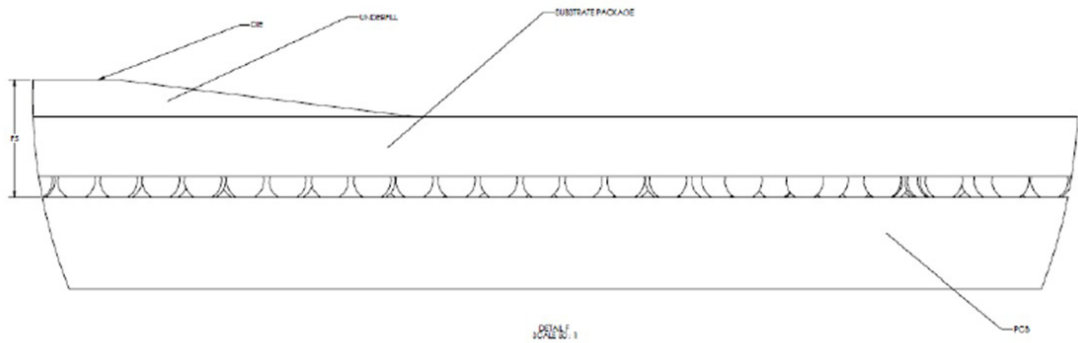

Figure 2.8 Assembly Drawing

Assembly Drawing

Please consider the CPU and chip height tolerance when designing your thermal solution.



Intel® Pentium and Celeron N and J Series
Figure 2.9 Main Chip Height and Tolerance

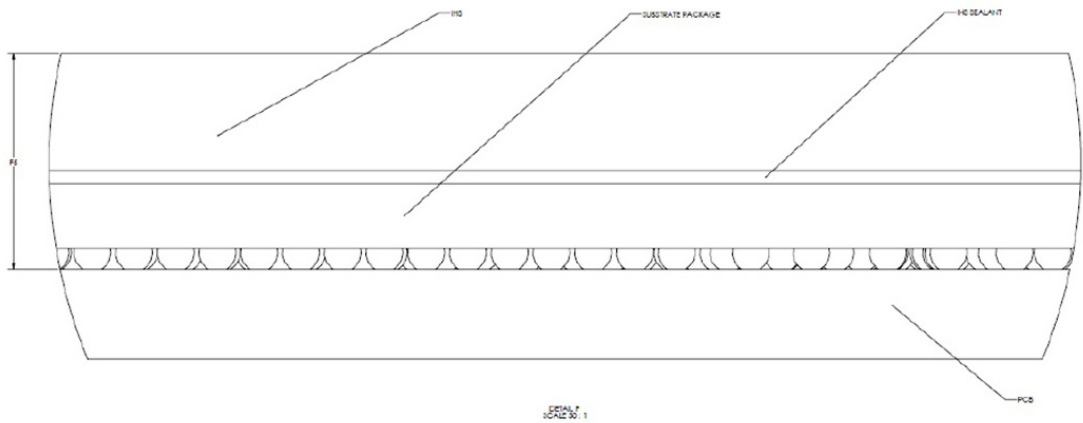

Intel® Atom™ Processor E3900 Series
Figure 2.10 Main Chip Height and Tolerance

Chapter 3

AMI BIOS

This chapter gives BIOS setup information for the SOM-7569 COM Express Mini CPU Module.

Sections include:

- Introduction
- Entering Setup
- Hot/Operation Key
- Exit BIOS Setup Utility

With the AMI BIOS Setup Utility, users can modify BIOS settings and control various system features. This chapter describes the basic navigation of the BIOS Setup Utility.



Figure 3.1 Setup program initial screen

AMI's BIOS ROM has a built-in Setup program that allows users to modify the basic system configuration. This information is stored in flash ROM so it retains the Setup information when the power is turned off.

3.1 Entering Setup

Turn on the computer and then press or <ESC> to enter Setup menu.

3.2 Main Setup

When users first enter the BIOS Setup Utility, users will enter the Main setup screen. Users can always return to the Main setup screen by selecting the Main tab. There are two Main Setup options. They are described in this section. The Main BIOS Setup screen is shown below.



Figure 3.2 Main setup screen

The Main BIOS setup screen has two main frames. The left frame displays all the options that can be configured. Grayed-out options cannot be configured; options in blue can. The right frame displays the key legend.

Above the key legend is an area reserved for a text message. When an option is selected in the left frame, it is highlighted in white. Often a text message will accompany it.

- **System time / System date**

Use this option to change the system time and date. Highlight System Time or System Date using the <Arrow> keys. Enter new values through the keyboard. Press the <Tab> key or the <Arrow> keys to move between fields. The date must be entered in MM/DD/YY format. The time must be entered in HH:MM:SS format.

3.3 Advanced BIOS Features Setup

Select the Advanced tab from the SOM-7569 setup screen to enter the Advanced BIOS Setup screen. Users can select any item in the left frame of the screen, such as CPU Configuration, to go to the sub menu for that item. Users can display an Advanced BIOS Setup option by highlighting it using the <Arrow> keys. All Advanced BIOS Setup options are described in this section. The Advanced BIOS Setup screens are shown below. The sub menus are described on the following pages.

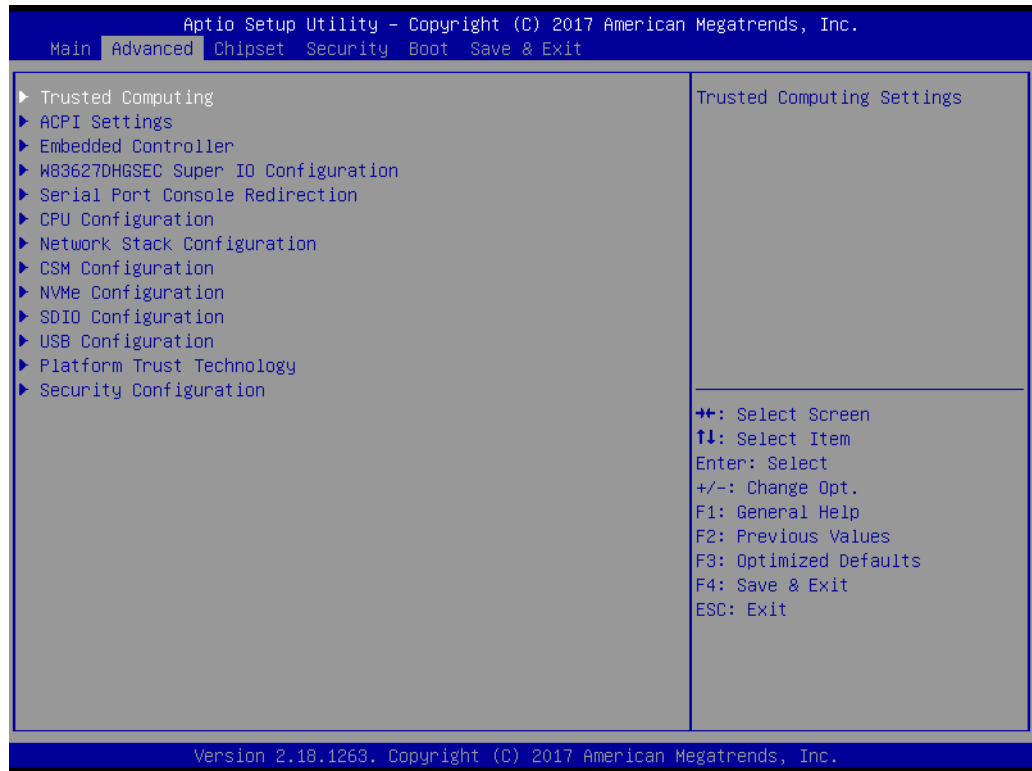

Figure 3.3 Advanced BIOS features setup screen

3.3.1 Trusted Computing



Figure 3.4 ACPI Settings

- Security Device Support**
 Enables or Disables BIOS support for security device. OS will not show Security Device. TCG EFI protocol and INT1A interface will not be available.

3.3.2 ACPI Settings

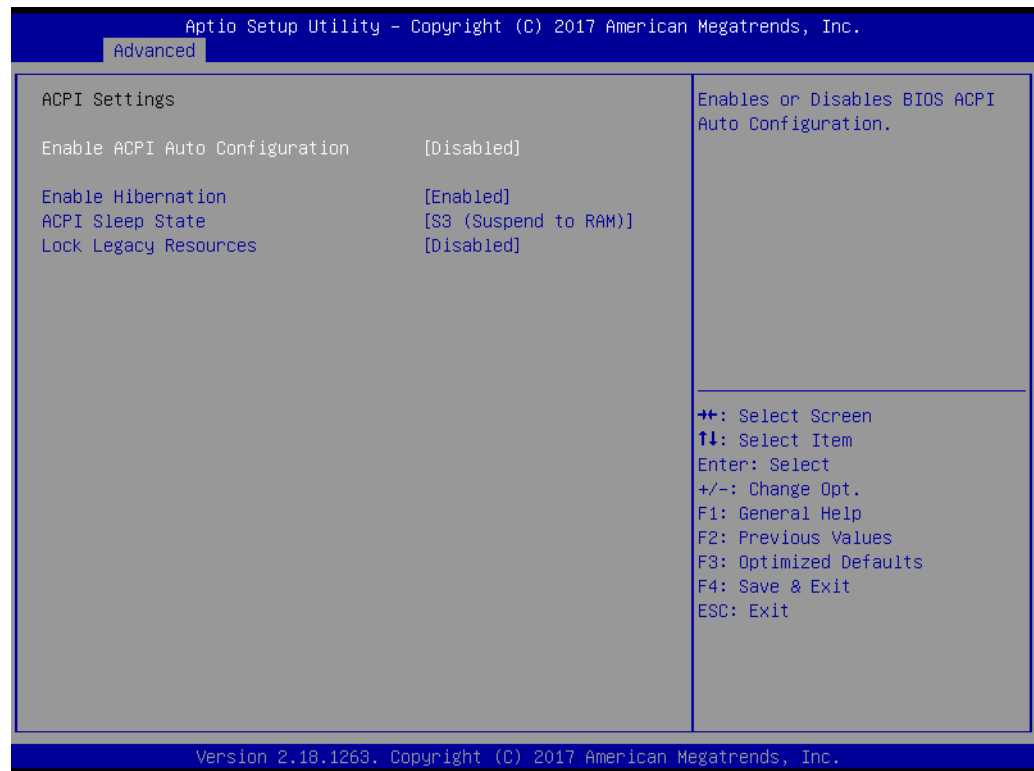

Figure 3.5 ACPI Settings

- **Enable ACPI Auto Configuration**
Enable/Disable BIOS ACPI Auto Configuration.
- **Enable Hibernation**
Enables or Disables System ability to Hibernation (OS/S4 Sleep State). This option may be not effective with some OS.
- **ACPI Sleep State**
Select the highest ACPI sleep state the system will enter when the SUSPEND button is pressed.
- **Lock Legacy Resources**
Enable or Disable Lock of Legacy Resources.

3.3.3 Embedded Controller

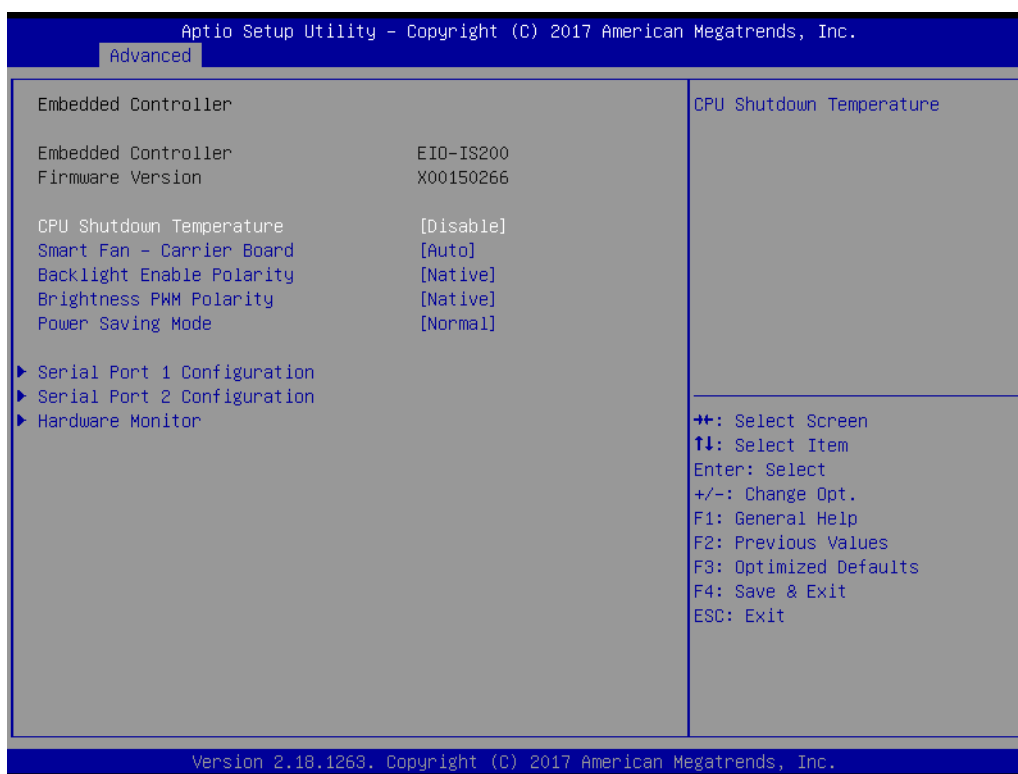

Figure 3.6 Embedded Controller

- **CPU Shutdown Temperature**
Enable/Disable CPU Shutdown Temperature.
- **Smart Fan – Carrier Board**
Control Carrier Board Smart FAN function. Get value from EC and only set value when Save Changes.
- **Backlight Enable Polarity**
Switch Backlight Enable Polarity for Native or Invert
- **Brightness PWM Polarity**
Backlight Control Brightness PWM Polarity for Native or Invert
- **Power Saving Mode**
Select Power Saving Mode
- **Serial Port 1 Configuration**
Set Parameters of Serial Port 1 (COMA)
- **Serial Port 2 Configuration**
Set Parameters of Serial Port 2 (COMB)
- **Hardware Monitor**
Monitor hardware status

3.3.4 Serial Port 1 Configuration

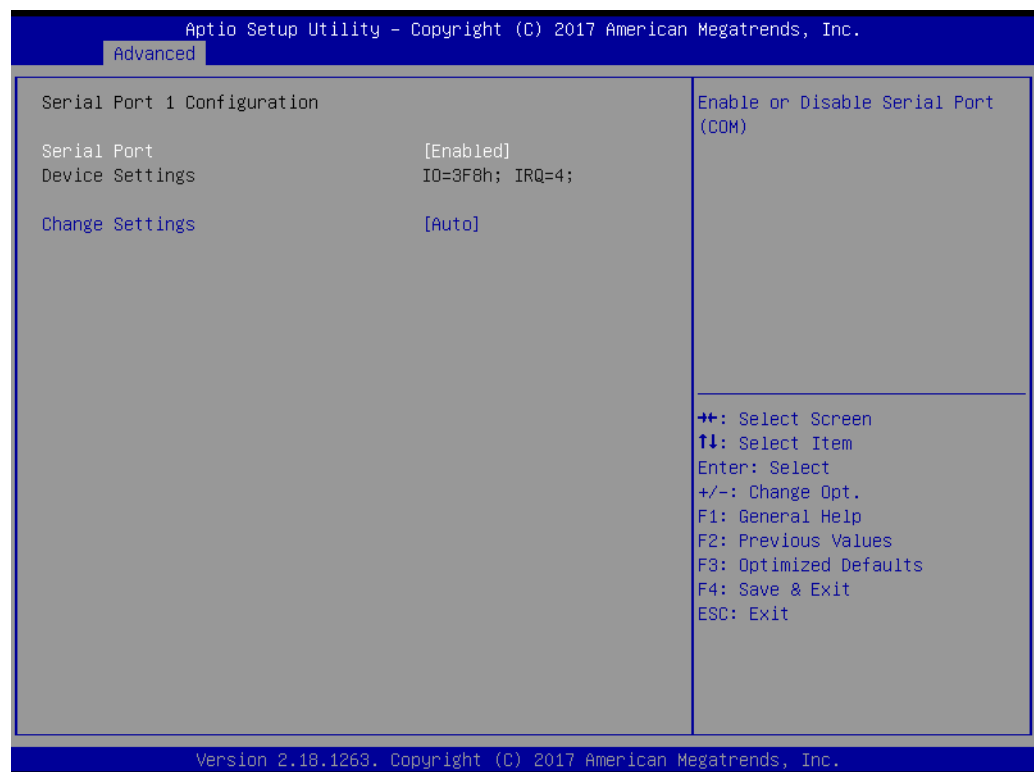

Figure 3.7 Serial Port 1 Configuration

- **Serial Port**
Enable/Disable Serial Port (COM).
- **Change Settings**
Select an optimal setting for Super IO device.

3.3.5 Serial Port 2 Configuration

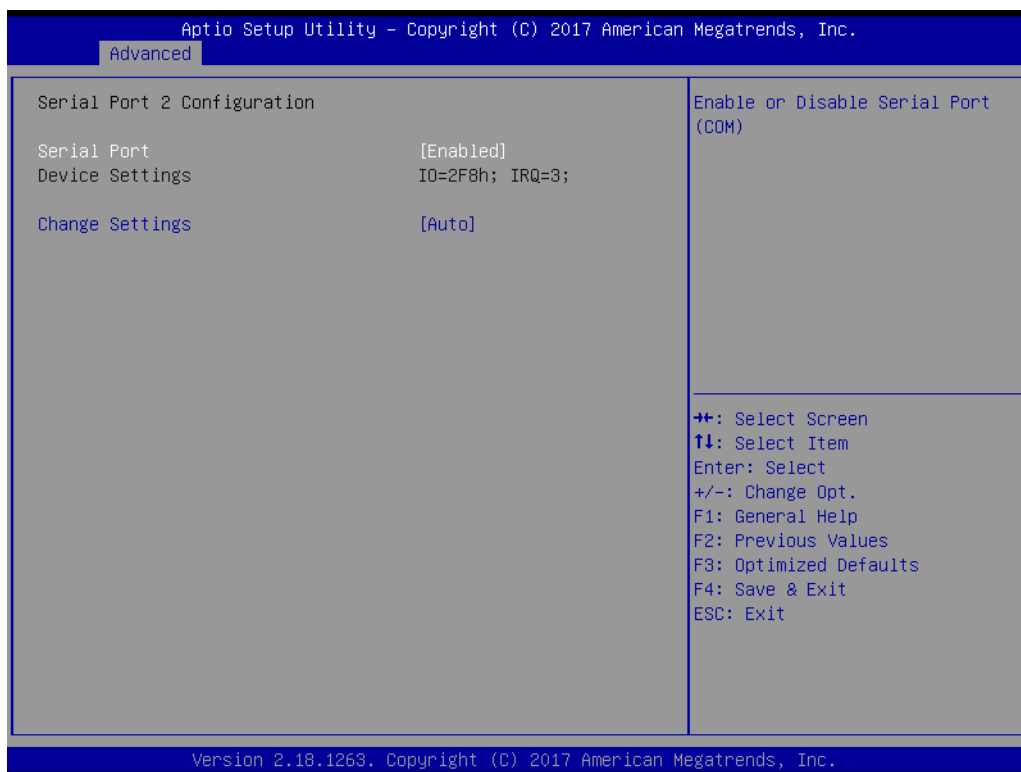

Figure 3.8 Serial Port 2 Configuration

- **Serial Port**
Enable/Disable Serial Port (COM).
- **Change Settings**
Select an optimal setting for Super IO device.

3.3.6 Hardware Monitor

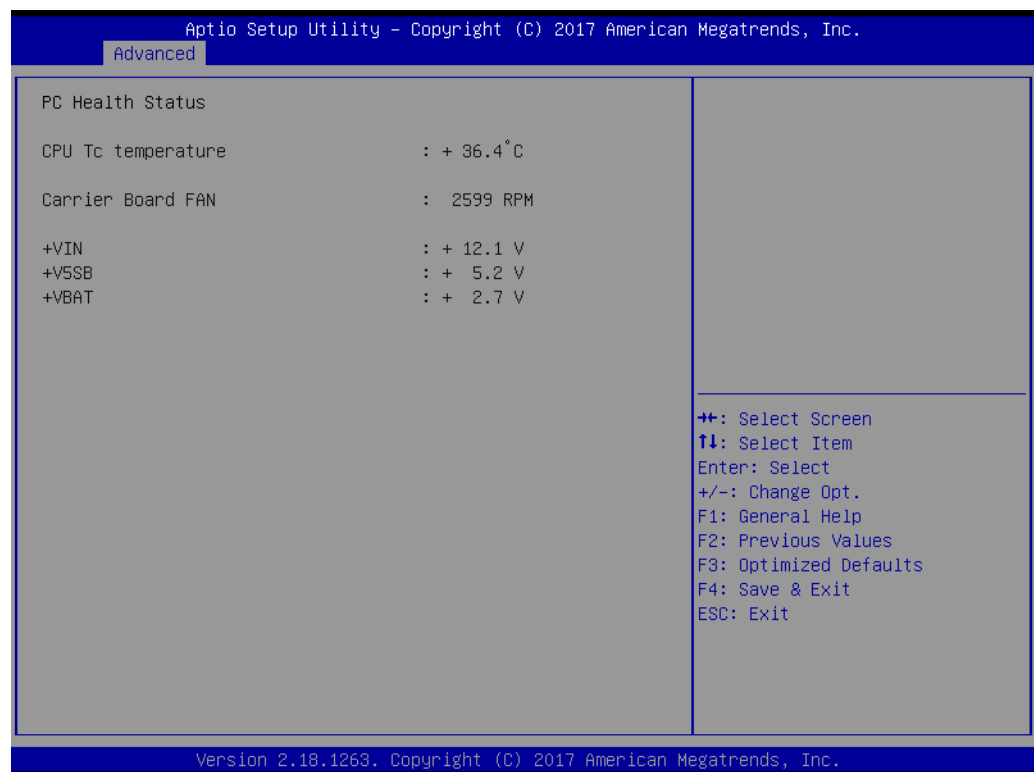

Figure 3.9 Hardware Monitor

- **Hardware Monitor Information**
This item shows Hardware information parameters.

3.4 W83627DHGSEC Super IO Configuration

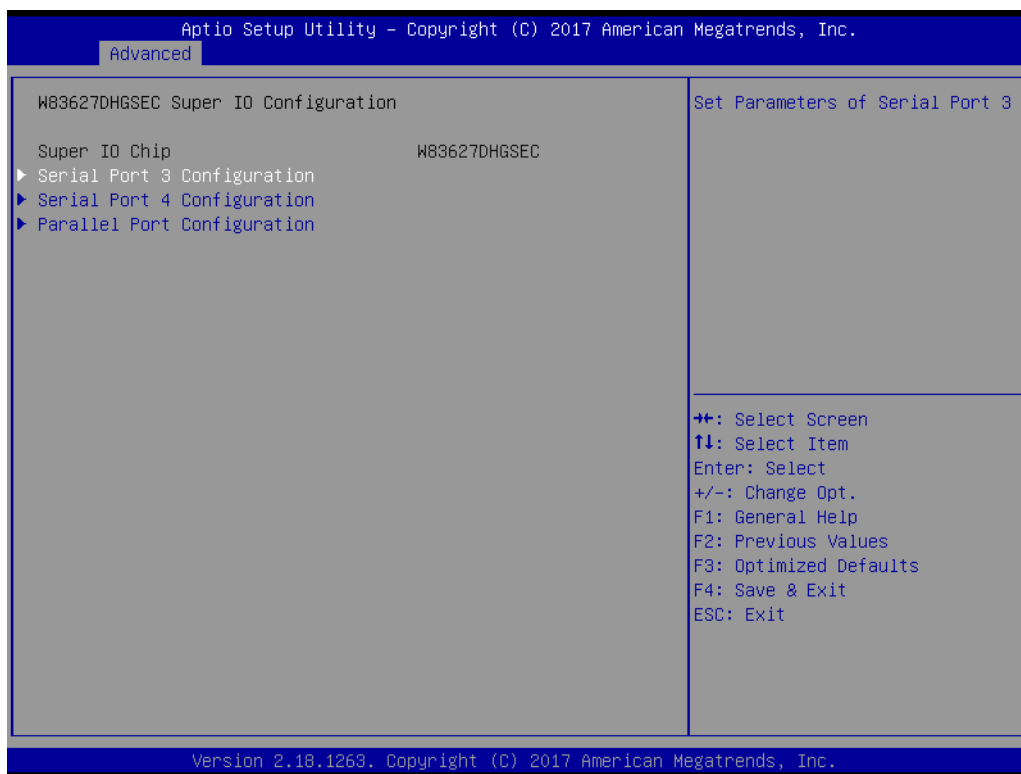

Figure 3.10 W83627DHGSEC Super IO Configuration

- **Serial Port 3 Configuration**
Set Parameters of Serial Port 3
- **Serial Port 4 Configuration**
Set Parameters of Serial Port 4
- **Parallel Port Configuration**
Set Parameters of Parallel Port (LPT/LPTE)

3.4.1 Serial Port 3 Configuration

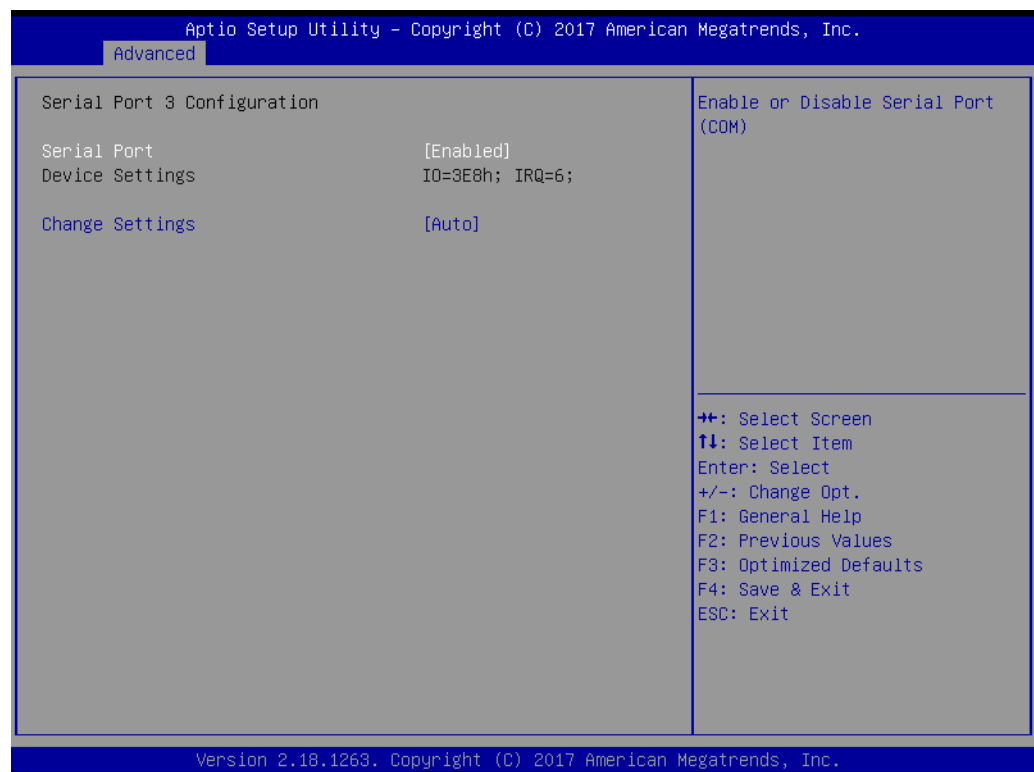

Figure 3.11 Serial Port 3 Configuration

- **Serial Port**
Enable or Disable Serial Port (COM).
- **Change Settings**
Select an optimal setting for Super IO device.

3.4.2 Serial Port 4 Configuration

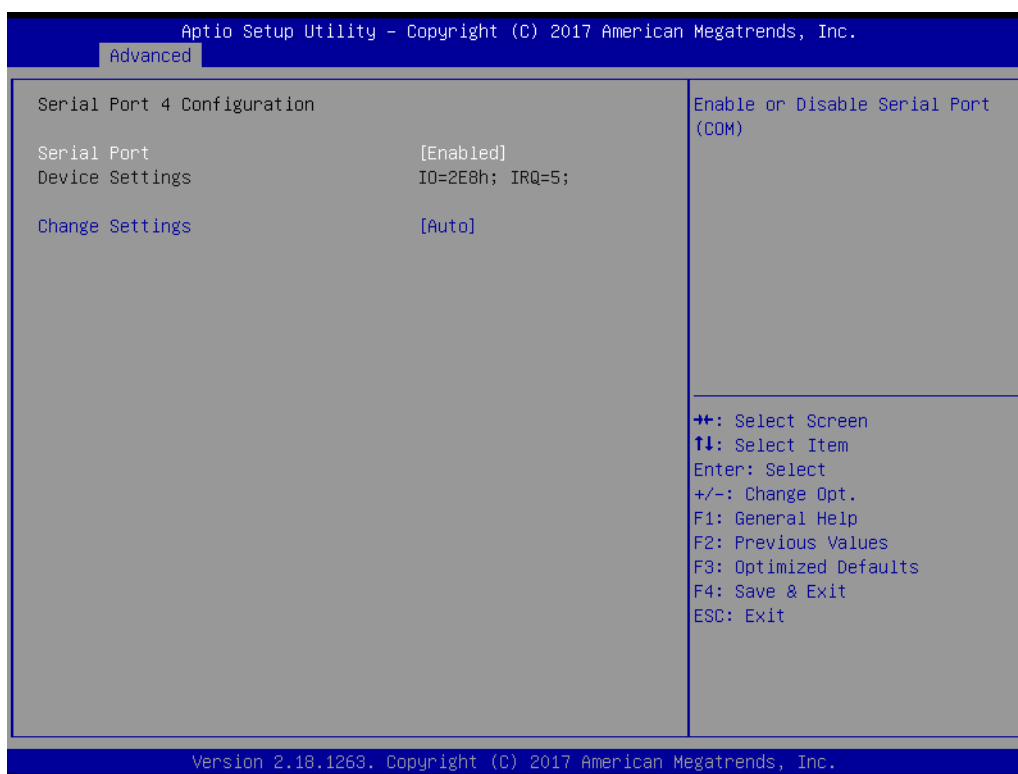

Figure 3.12 Serial Port 4 Configuration

- **Serial Port**
Enable or Disable Serial Port (COM)
- **Change Settings**
Select an optimal setting for Super IO device.

3.4.3 Parallel Port Configuration

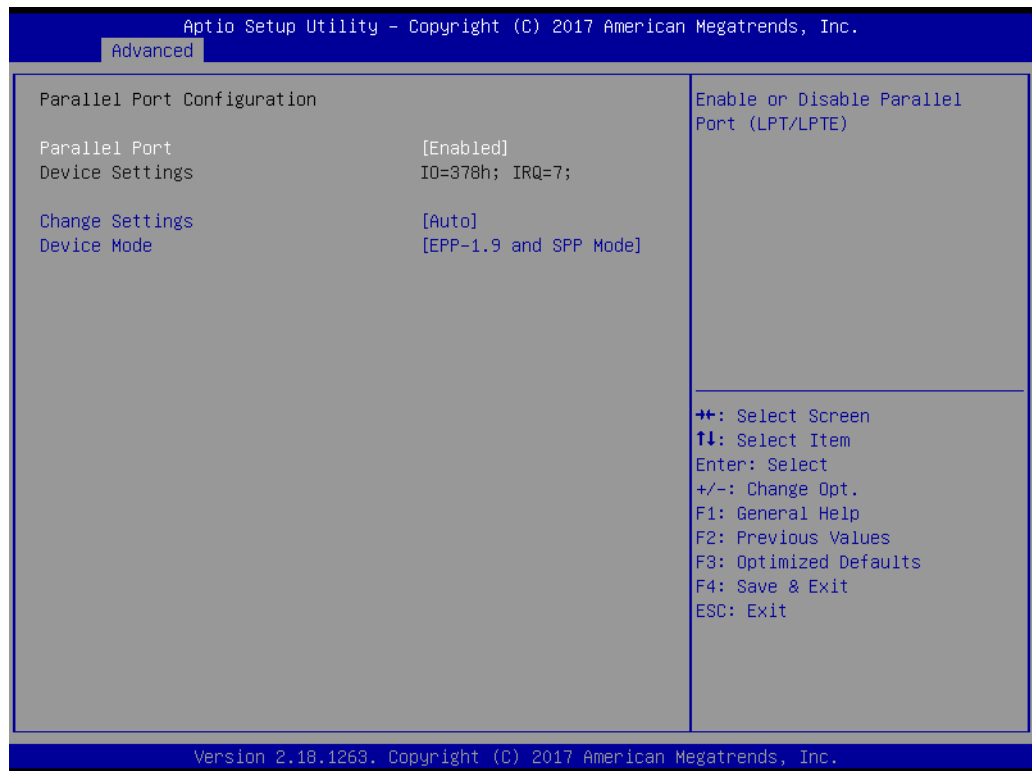

Figure 3.13 Parallel Port Configuration

- **Parallel Port**
Enable or Disable Parallel Port (LPT/LPTE).
- **Change Settings**
Select an optimal setting for Super IO device.
- **Device Mode**
Change the Printer Port mode.

3.4.4 Serial Port Console Redirection

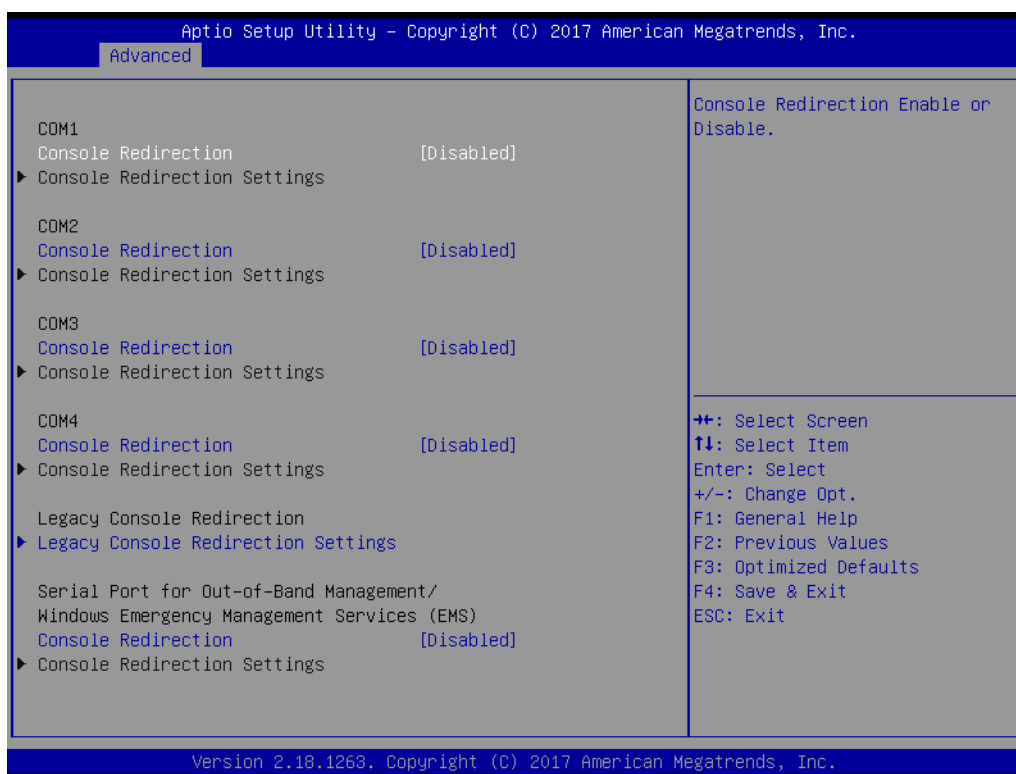

Figure 3.14 Serial Port Console Redirection

- **COM1 Console Redirection**
Console Redirection Enable or Disable.
- **COM2 Console Redirection**
Console Redirection Enable or Disable.
- **Legacy Console Redirection Settings**
Change Legacy Console Redirection Settings.
- **Console Redirection**
Console Redirection Enable or Disable.

3.4.4.1 Legacy Console Redirection Settings



Figure 3.15 Legacy Console Redirection Settings

- **Legacy Console Redirection Settings**
Select a COM port to display redirection of Legacy OS and Legacy OPROM Messages.

3.4.5 CPU Configuration

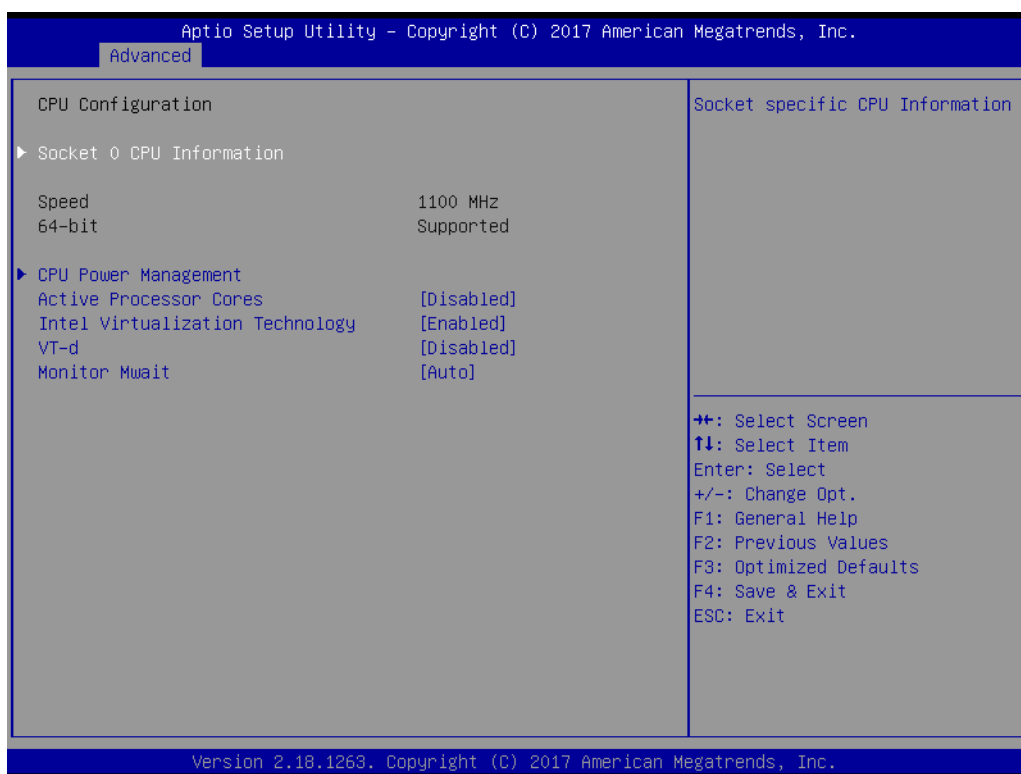

Figure 3.16 CPU Configuration

- **Socket 0 CPU Information**
Socket specific CPU Information.
- **CPU Power Management**
CPU Power Management options.
- **Active Processor Cores**
Number of cores to enable in each processor package.
- **Intel Virtualization Technology**
When enabled, a VMM can utilize the additional hardware capabilities provided by Vanderpool Technology.
- **VT-d**
Enable/Disable CPU VT-d.
- **Monitor Mwait**
Enable/Disable Monitor Mwait.

3.4.6 Socket 0 CPU Configuration

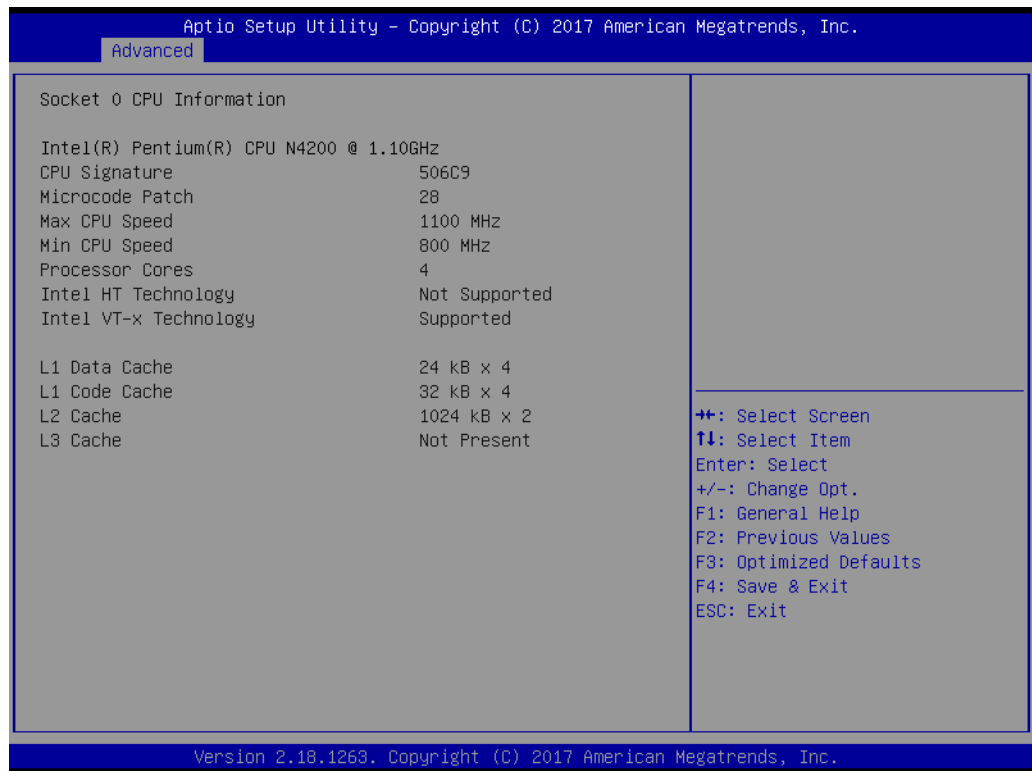

Figure 3.17 Socket 0 CPU Configurations

- **Socket 0 CPU Information**
Socket specific CPU Information.

3.4.7 CPU Power Management

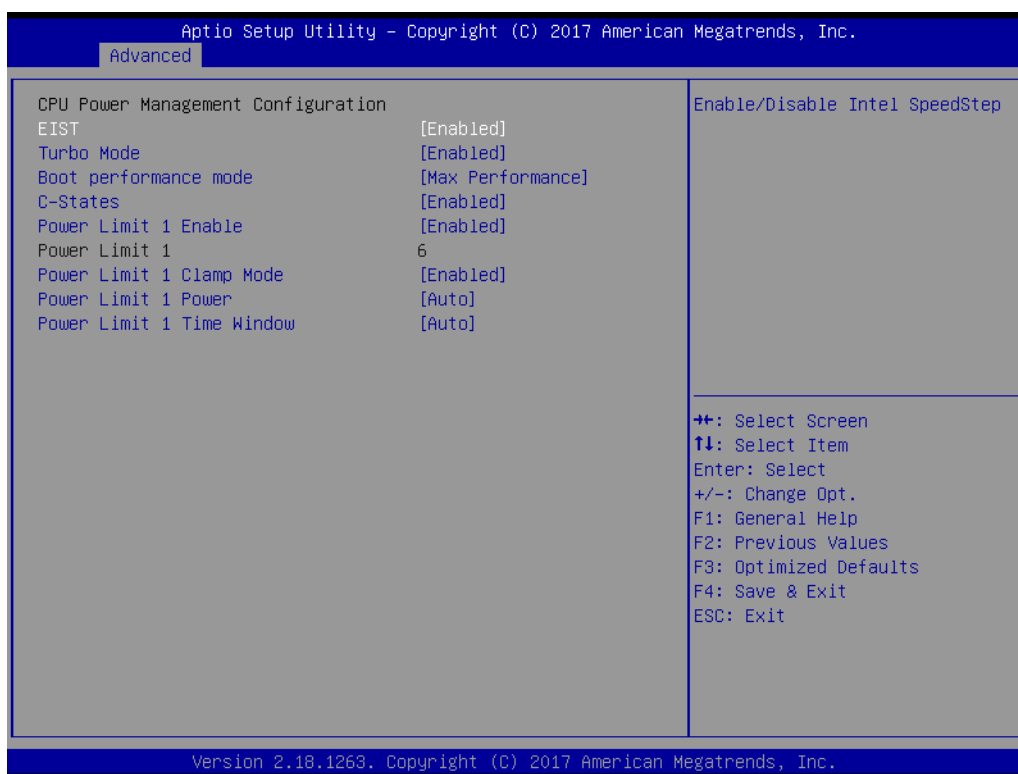

Figure 3.18 Socket 0 CPU Configurations

- **EIST**
Enable/Disable Intel SpeedStep.
- **Turbo Mode**
Enable/Disable Turbo Mode.
- **Boot performance mode**
Select the performance state that the BIOS will set before OS handoff.
- **C-States**
Enable/Disable C States.
- **Power Limit 1 Enable**
Enable/Disable Power Limit 1.
- **Power Limit 1 Clamp Mode**
Enable/Disable Power Limit 1 Clamp Mode.
- **Power Limit 1 Power**
Power Limit 1 in Watts. Auto will program Power Limit 1 based on silicon default support value.
- **Power Limit 1 Time Window**
Power Limit 1 Time Window Value in Seconds. Auto will program Power Limit 1 Time Window based on silicon default support value.

3.4.8 Network Stack Configuration



Figure 3.19 Network Stack Configuration

- **Network Stack**
Enable/Disable UEFI Network Stack.

3.4.9 CSM Configuration

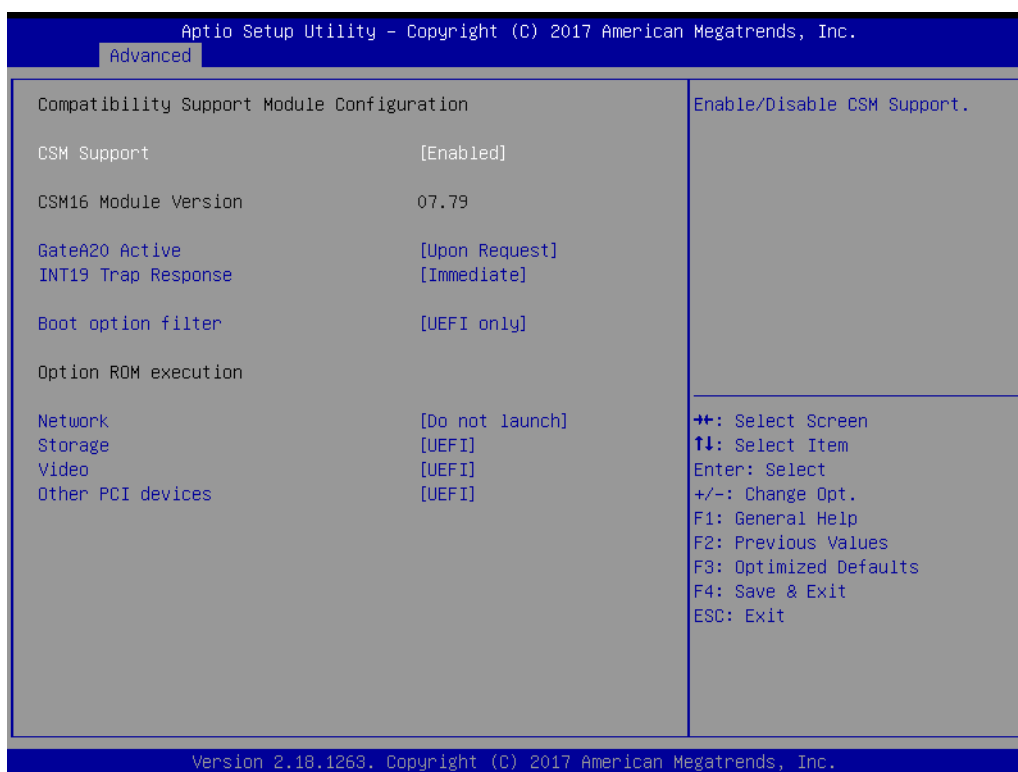

Figure 3.20 CSM Configuration

- **CSM Support**
Enable/Disable CSM Support.
- **GateA20 Active**
UPON Request- GA20 can be disabled using BIOS services. Always – do not allow disabling GA20; this option is useful when any RT code is executed above 1MB.
- **INT19 Trap Response**
BIOS reaction on INT19 trapping by Option ROM:
IMMEDIATE- execute the trap right away;
POSTPONED- execute the trap during legacy boot.
- **Boot option filter**
This option controls Legacy/UEFI ROMs priority.
- **Network**
Controls the execution of UEFI and Legacy PXE OpROM.
- **Storage**
Controls the execution of UEFI and Legacy Storage OpROM.
- **Video**
Controls the execution of UEFI and Legacy Video OpROM.
- **Other PCI devices**
Determines OpROM execution policy for devices other than Network, Storage, or Video.

3.4.10 NVMe Configuration

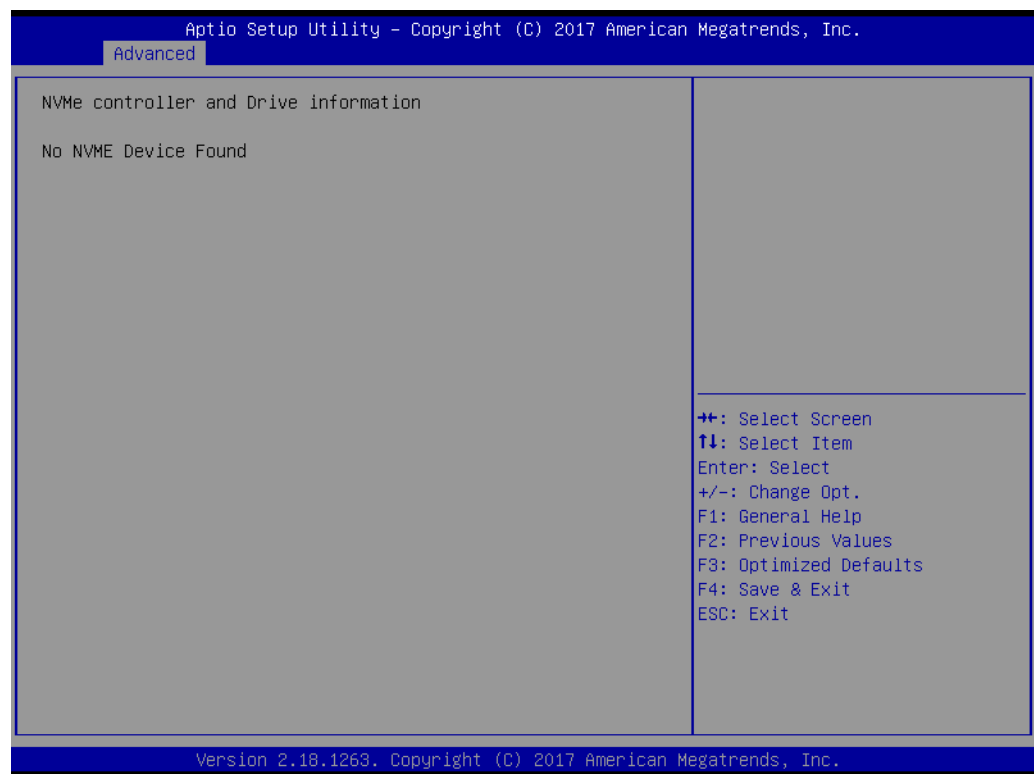

Figure 3.21 NVMe Configuration

- **NVMe Configuration**
NVMe controller and driver information.

3.4.11 SDIO Configuration

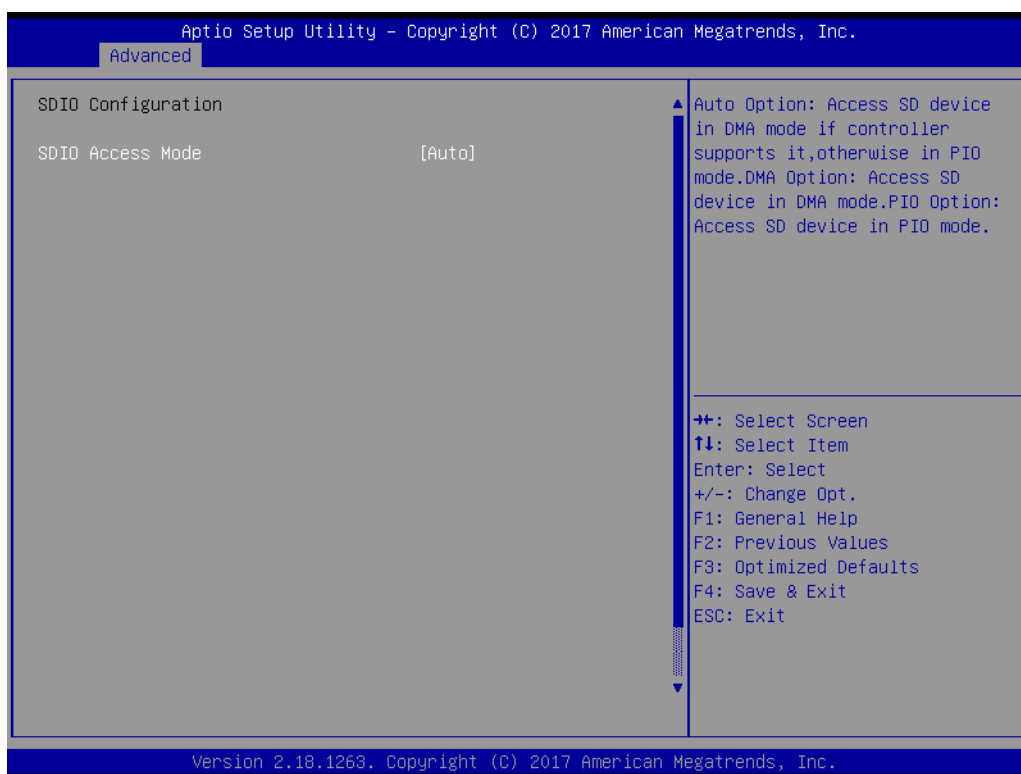

Figure 3.22 SDIO Configuration

- **SDIO Access Mode**

Auto option: Access SD device in DMA mode if controller supports it, otherwise in PIO mode. DMA option: Access SD device in DMA mode. PIO Option: Access SD device in PIO mode.

3.4.12 USB Configuration

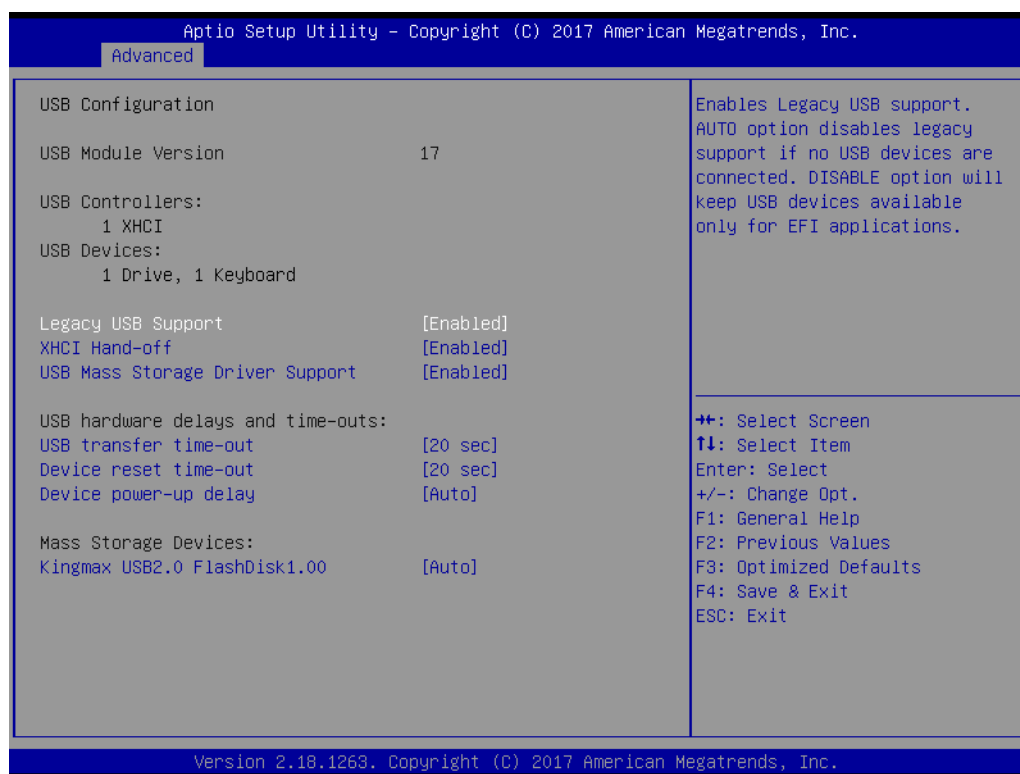

Figure 3.23 USB Configuration

- **Legacy USB Support**
Enables Legacy USB support. Auto option disables legacy support if no USB devices are connected. Disable option will keep USB devices available only for EFI applications.
- **XHCI Hand-off**
This is a workaround for OSES without XHCI ownership change should be claimed by XHCI driver.
- **USB Mass Storage Driver Support**
Enable/Disable USB Mass Storage Driver Support.
- **USB transfer time-out**
The time-out value for Control, Bulk, and Interrupt transfers.
- **Device reset time-out**
USB mass storage device Start Unit command time-out.
- **Device power-up delay**
Maximum time the device will take before it properly reports itself to the Host Controller.
'Auto' uses default value: for a Root port it is 100ms, for a Hub port the delay is taken from Hub descriptor.

3.4.13 Platform Trust Technology

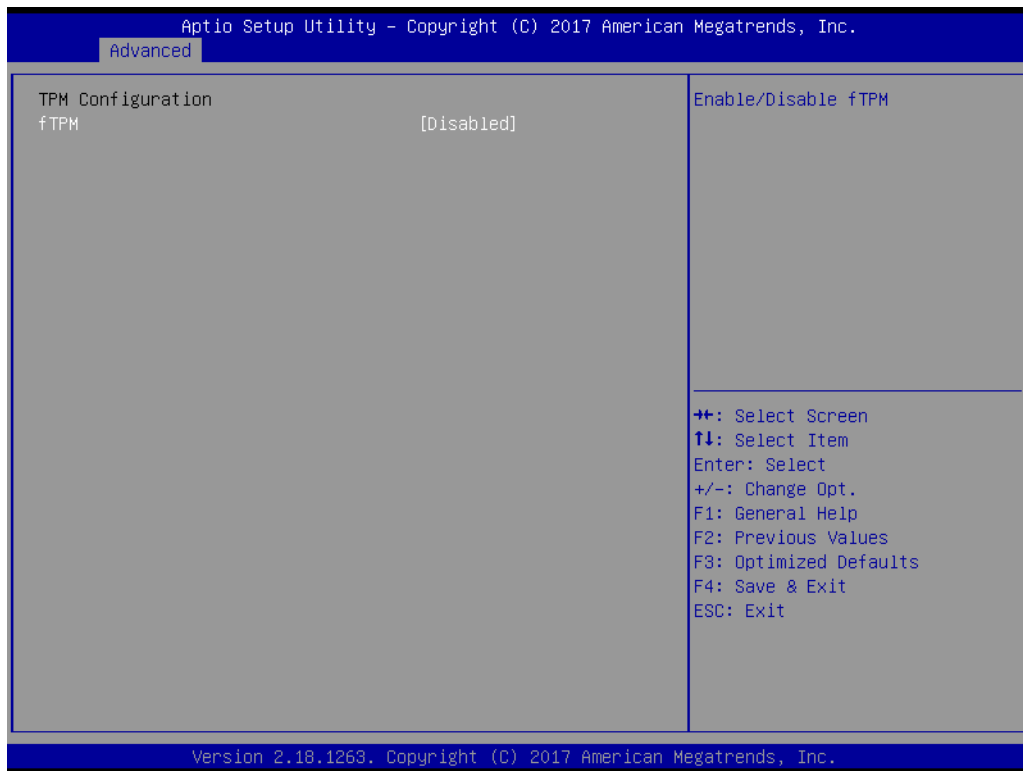

Figure 3.24 Platform Trust Technology

- **fTPM**
Enable/Disable fTPM

3.4.14 Security Configuration

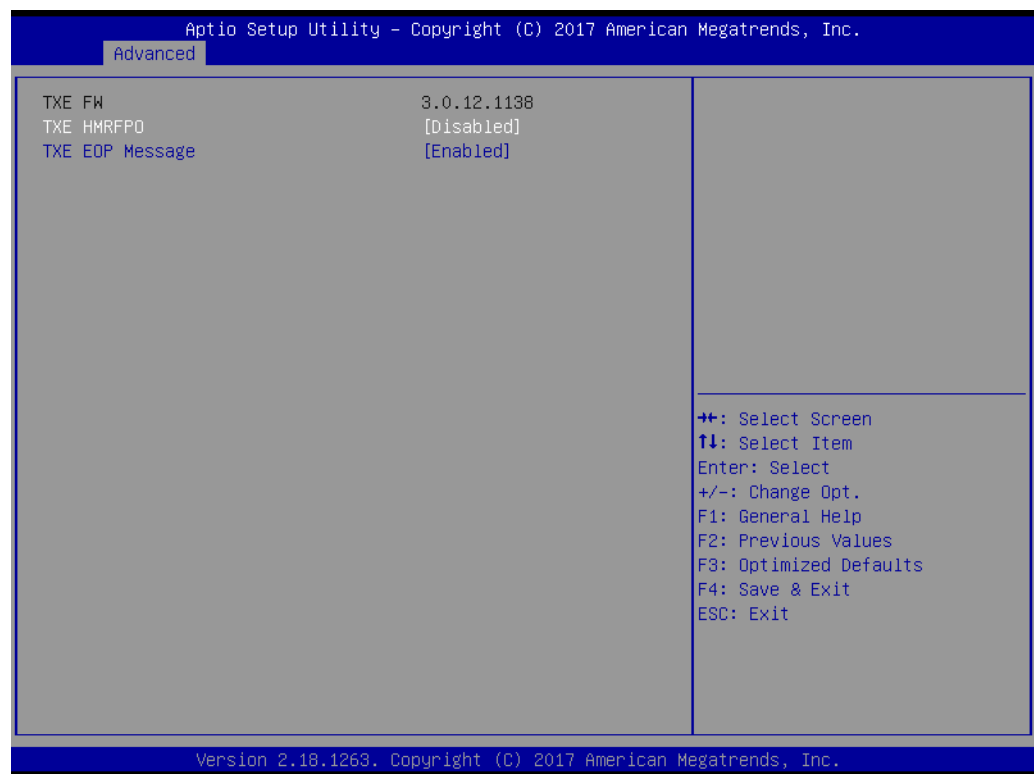

Figure 3.25 Security Configuration

- **TXE HMRFP0**
Enable/Disable TXE HMRFP0.
- **TXE EOP Message**
Send EOP Message Before Enter OS.

3.5 Chipset

Select the Chipset tab from the SOM-7569 setup screen to enter the Chipset BIOS Setup screen. You can display a Chipset BIOS Setup option by highlighting it using the <Arrow> keys. All Plug and Play BIOS Setup options are described in this section. The Plug and Play BIOS Setup screen is shown below.

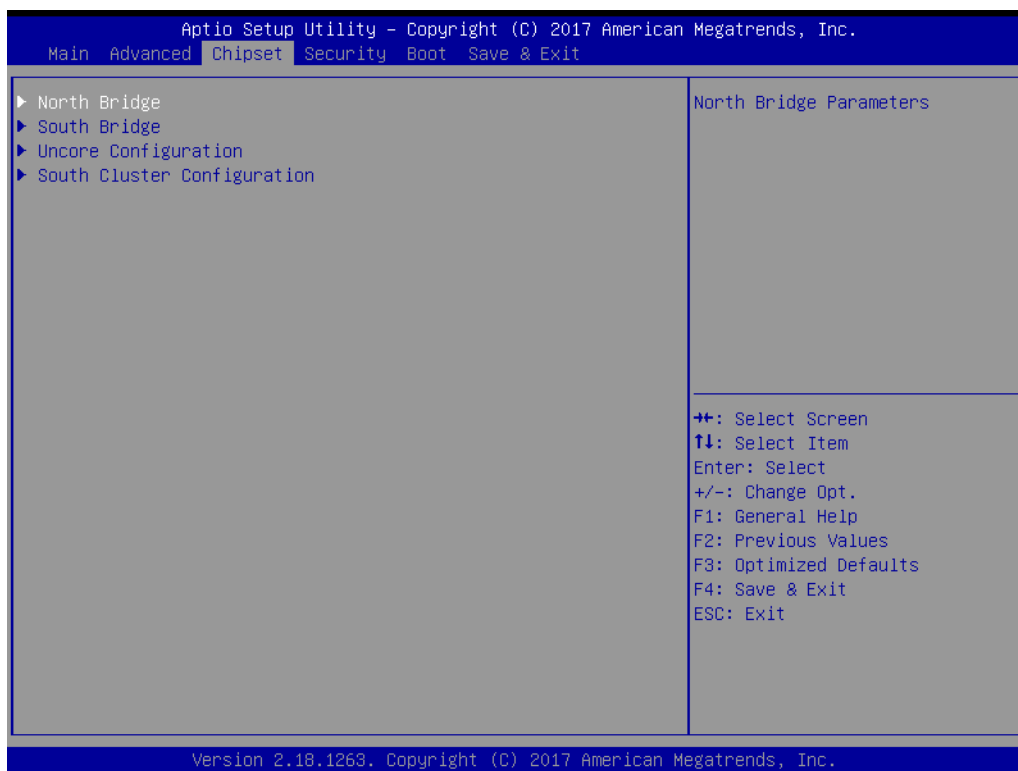

Figure 3.26 Chipset Setup

- **North Bridge**
North Bridge Parameters.
- **South Bridge**
South Bridge Parameters.
- **Uncore Configuration**
Uncore Configuration.
- **South Cluster Configuration**
South Cluster Configuration.

3.5.1 North Bridge

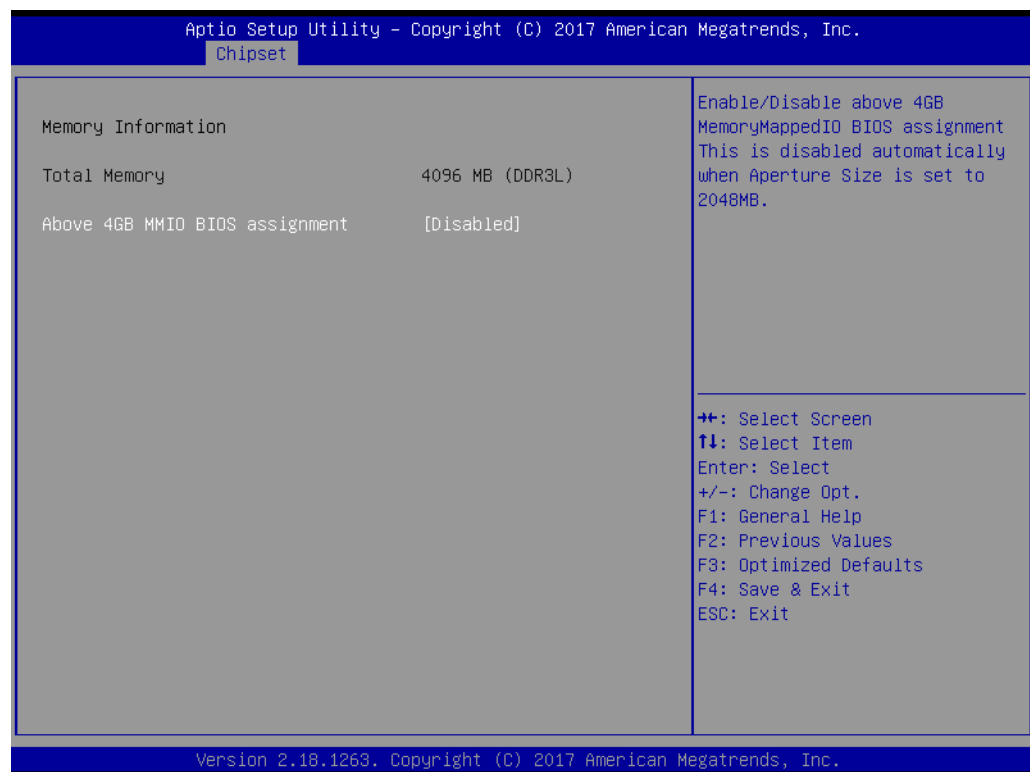

Figure 3.27 North Bridge

- **Above 4GB MMIO BIOS assignment**
Enable/Disable above 4GB MemoryMappedIO BIOS assignment. This is disabled automatically when Aperture Size is set to 2048MB.

3.5.2 South Bridge

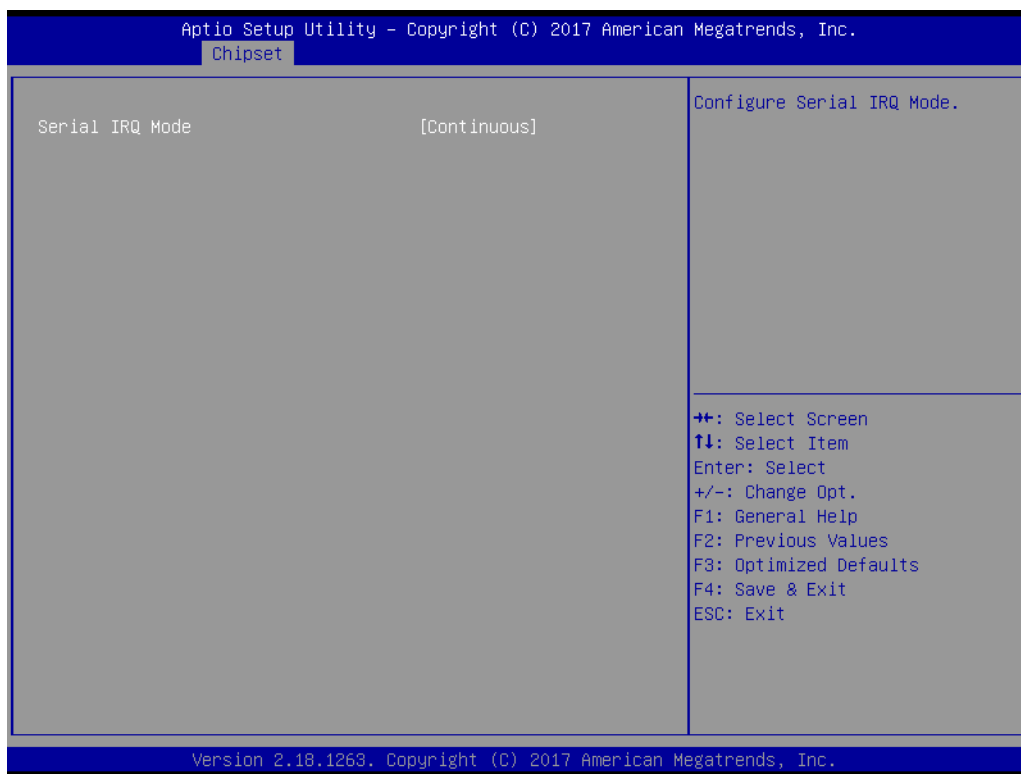

Figure 3.28 South Bridge

- **Serial IRQ Mode**
Configure Serial IRQ Mode.

3.5.3 Uncore Configuration

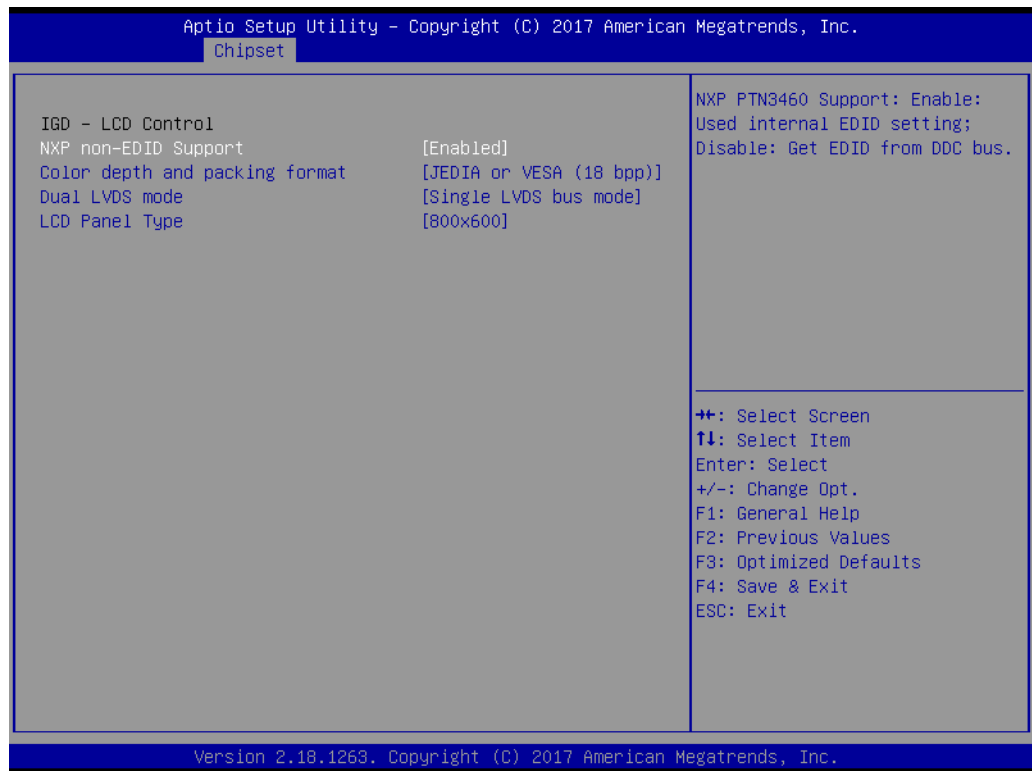

Figure 3.29 Uncore Configuration

- **NXP non-EDID Support**
NXP PTN3460 Support: Enable: Used internal EDID setting; Disable: Get EDID form DDC bus.
- **Color depth and packing format**
Select Color depth and packing format setting.
- **Dual LVDS mode**
Select Dual LVDS mode settings.
- **LCD Panel Type**
Select LCD panel used by Internal Graphics Device by selecting the appropriate setup item.

3.5.4 South Cluster Configuration

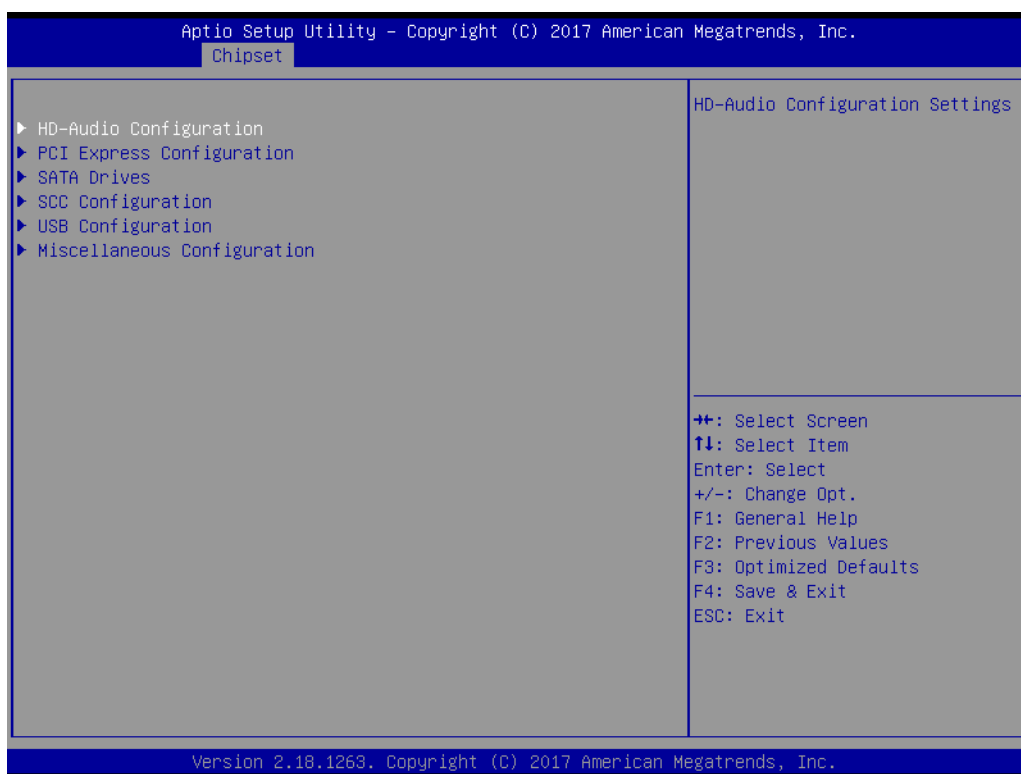

Figure 3.30 South Cluster Configuration

- **HD-Audio Configuration**
HD-Audio Configuration Settings.
- **PCI Express Configuration**
PCI Express Configuration Settings.
- **SATA Drives**
Press <Enter> to select the SATA Device Configuration Setup options.
- **SCC Configuration**
SCC Configuration Settings.
- **USB Configuration**
USB Configuration Settings.
- **Miscellaneous Configuration**
Enable/Disable Misc. Features.

3.5.4.1 HD-Audio Configuration

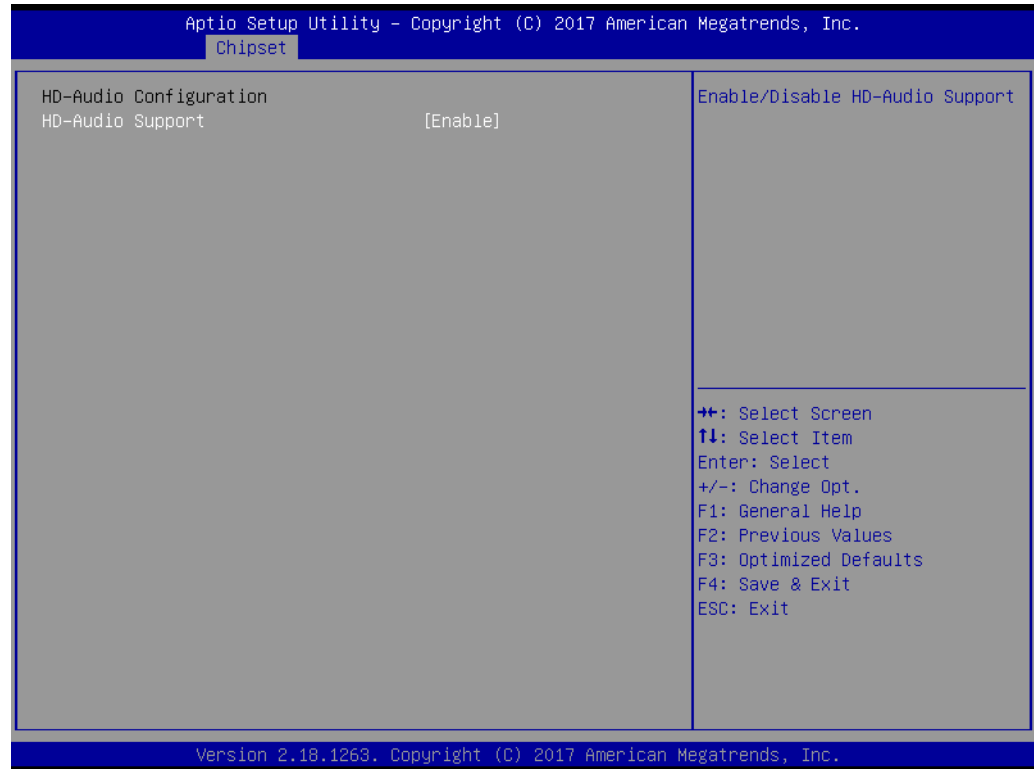

Figure 3.31 HD-Audio Configuration

- **HD-Audio Support**
Enable/Disable HD-Audio Support.

3.5.4.2 PCI Express Configuration

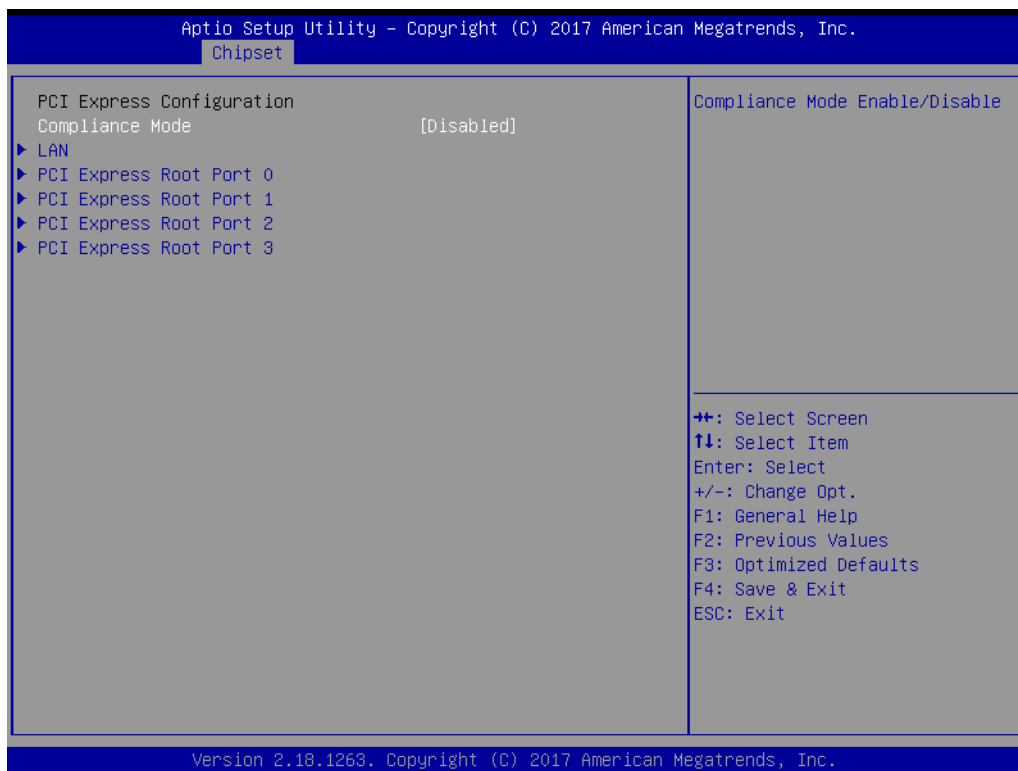

Figure 3.32 PCI Express Configuration

- **Compliance Mode**
Compliance Mode Enable/Disable.
- **LAN**
Control the PCI Express Root Port.
Auto: To disable unused root port automatically for the most optimum power savings.
Enable: Enable PCIe root port.
Disable: Disable PCIe root port.
- **PCI Express Root Port 0**
Control the PCI Express Root Port.
Auto: To disable unused root port automatically for the most optimum power savings.
Enable: Enable PCIe root port.
Disable: Disable PCIe root port.
- **PCI Express Root Port 1**
Control the PCI Express Root Port.
Auto: To disable unused root port automatically for the most optimum power savings.
Enable: Enable PCIe root port.
Disable: Disable PCIe root port.
- **PCI Express Root Port 2**
Control the PCI Express Root Port.
Auto: To disable unused root port automatically for the most optimum power savings.

Enable: Enable PCIe root port.

Disable: Disable PCIe root port.

■ **PCI Express Root Port 3**

Control the PCI Express Root Port.

Auto: To disable unused root port automatically for the most optimum power savings.

Enable: Enable PCIe root port.

Disable: Disable PCIe root port.

3.5.4.2.1 LAN

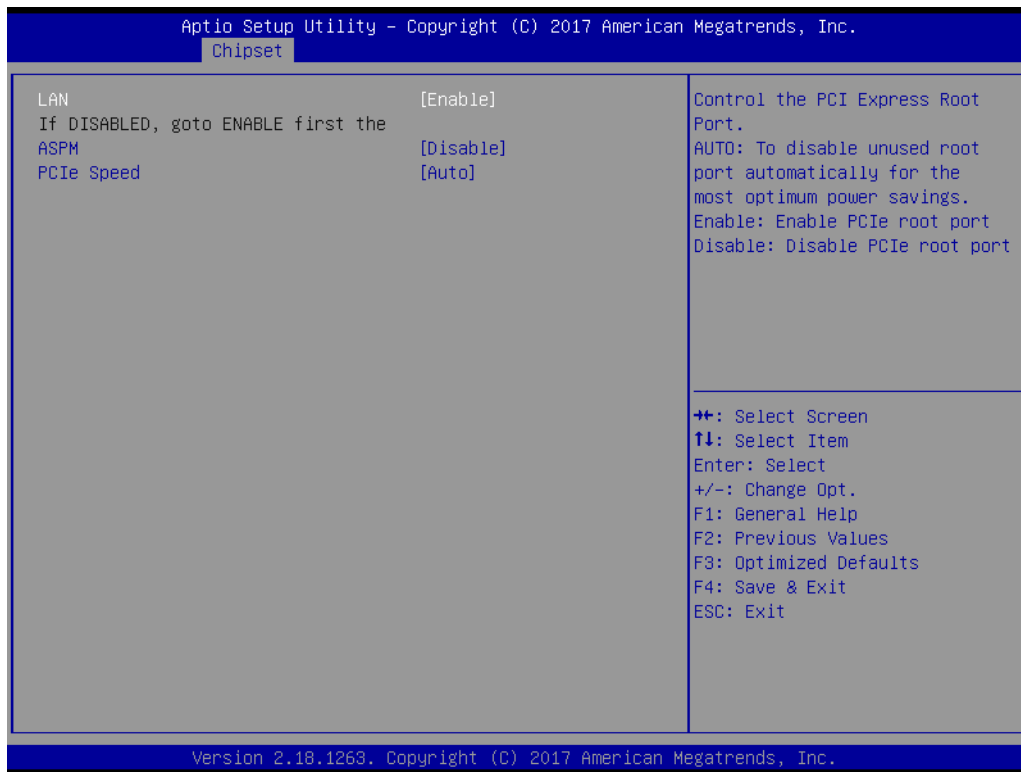

Figure 3.33 LAN

- **LAN**
Control the PCI Express Root Port
Auto: To disable unused root port automatically for the most optimum power savings.
Enable: Enable PCIe root port.
Disable: Disable PCIe root port.
- **ASPM**
PCI Express Active State Power Management settings.
- **PCIe Speed**
Configure PCIe Speed.

3.5.4.2.2 PCI Express Root Port 0 Configuration

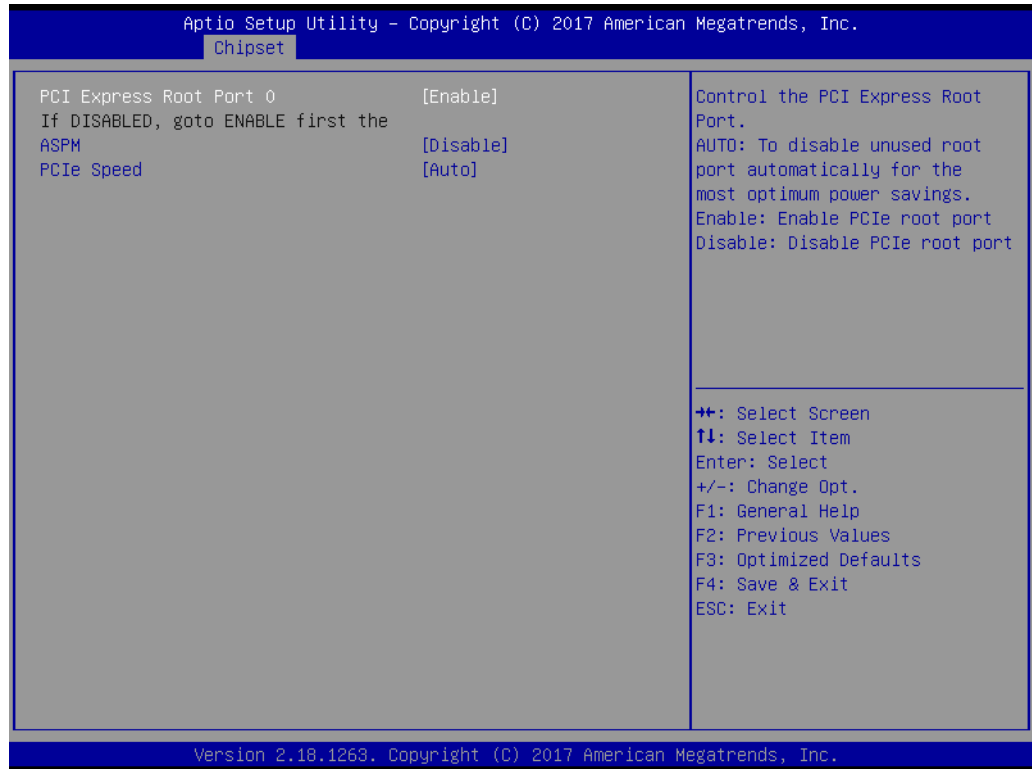

Figure 3.34 PCI Express Root Port 0 Configuration

- **PCI Express Root Port 0**
Control the PCI Express Root Port
Auto: To disable unused root port automatically for the most optimum power savings.
Enable: Enable PCIe root port.
Disable: Disable PCIe root port.
- **ASPM**
PCI Express Active State Power Management settings.
- **PCIe Speed**
Configure PCIe Speed.

3.5.4.2.3 PCI Express Root Port 1 Configuration

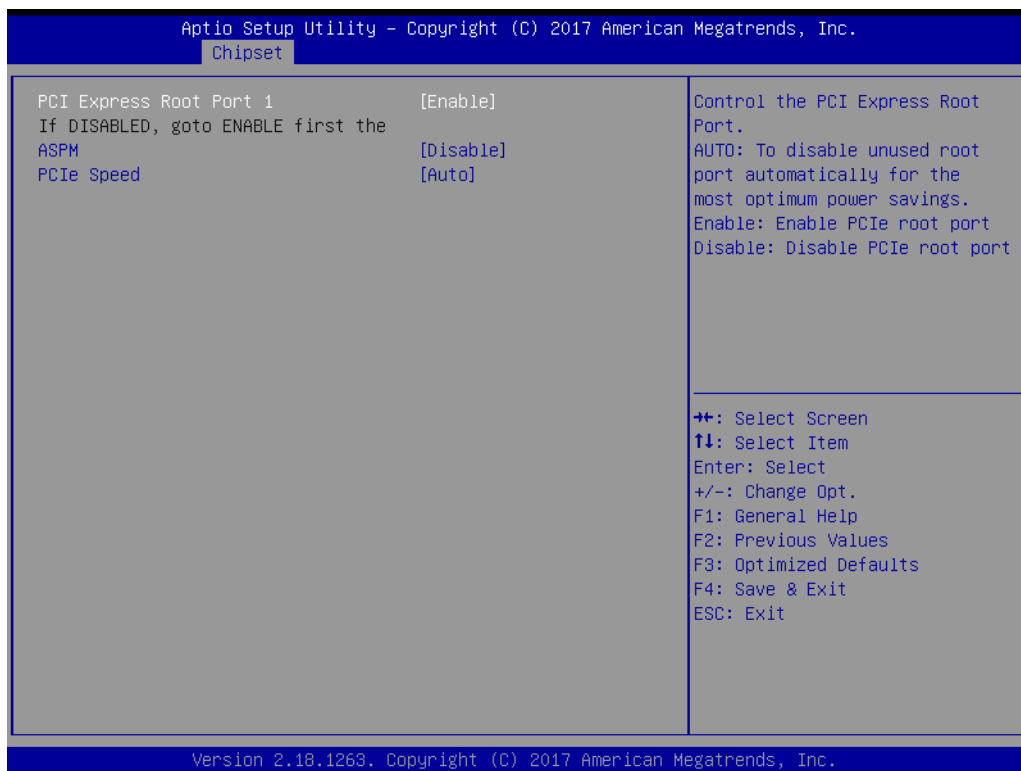

Figure 3.35 PCI Express Root Port 1 Configuration

- **PCI Express Root Port 1**
Control the PCI Express Root Port
Auto: To disable unused root port automatically for the most optimum power savings.
Enable: Enable PCIe root port.
Disable: Disable PCIe root port.
- **ASPM**
PCI Express Active State Power Management settings.
- **PCIe Speed**
Configure PCIe Speed.

3.5.4.2.4 PCI Express Root Port 2 Configuration

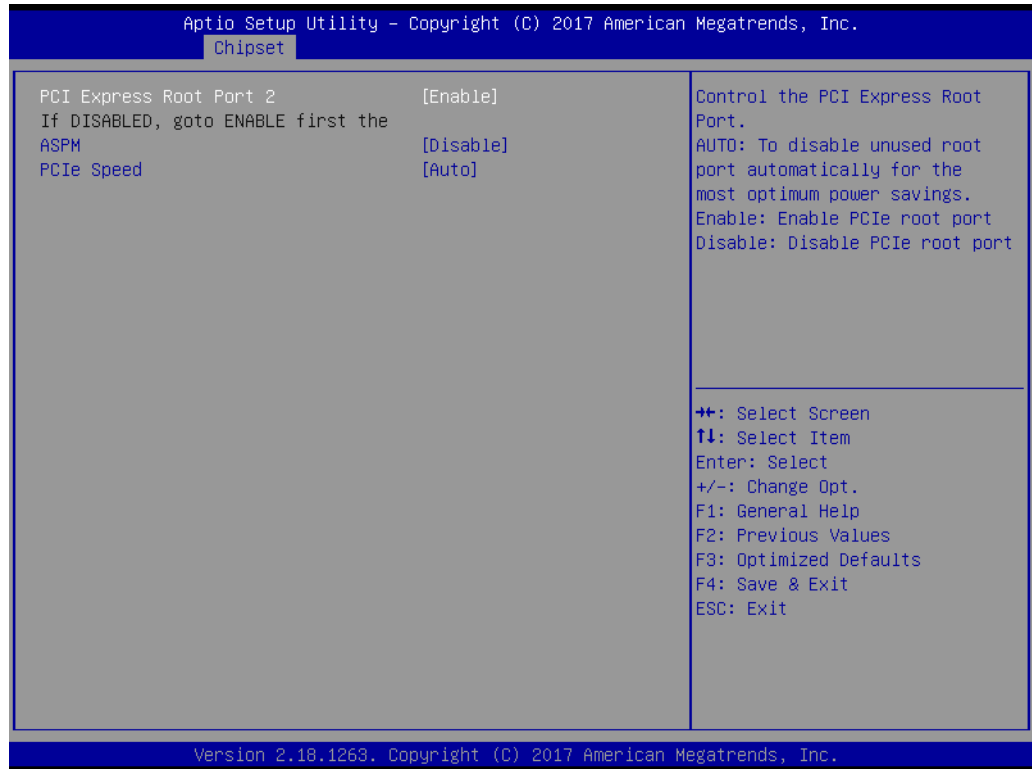

Figure 3.36 PCI Express Root Port 2 Configuration

- **PCI Express Root Port 2**
Control the PCI Express Root Port
Auto: To disable unused root port automatically for the most optimum power savings.
Enable: Enable PCIe root port.
Disable: Disable PCIe root port.
- **ASPM**
PCI Express Active State Power Management settings.
- **PCIe Speed**
Configure PCIe Speed.

3.5.4.2.5 PCI Express Root Port 3 Configuration

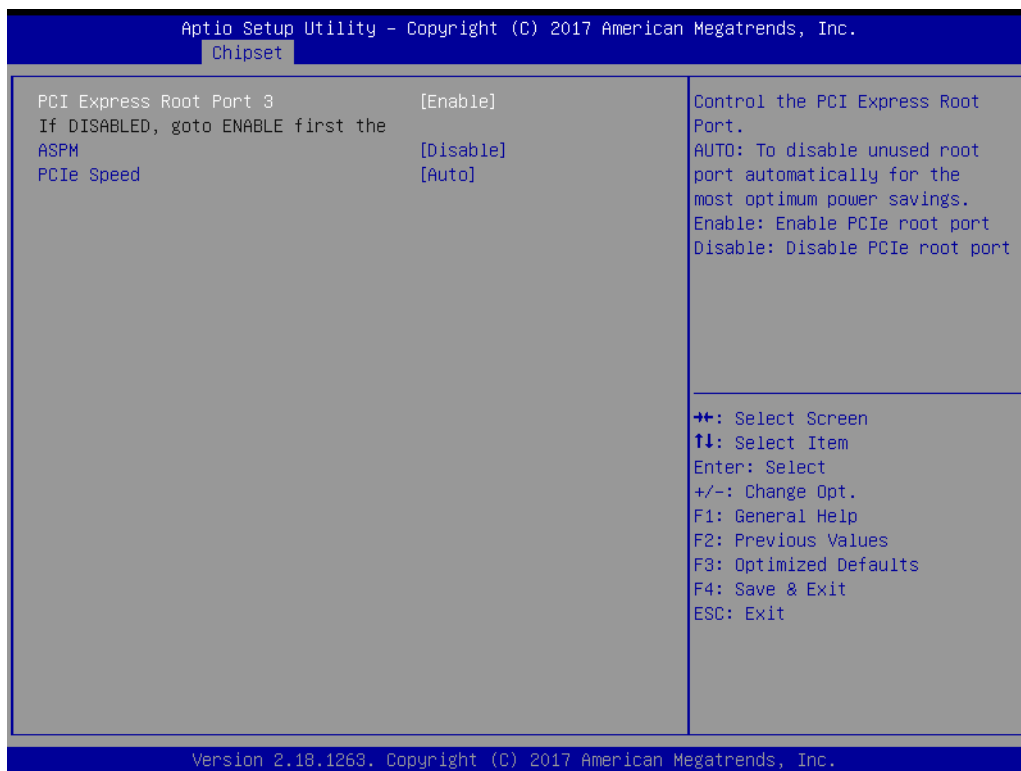

Figure 3.37 PCI Express Root Port 3 Configuration

- **PCI Express Root Port 3**
Control the PCI Express Root Port
Auto: To disable unused root port automatically for the most optimum power savings.
Enable: Enable PCIe root port.
Disable: Disable PCIe root port.
- **ASPM**
PCI Express Active State Power Management settings.
- **PCIe Speed**
Configure PCIe Speed.

3.5.4.3 SATA Drives

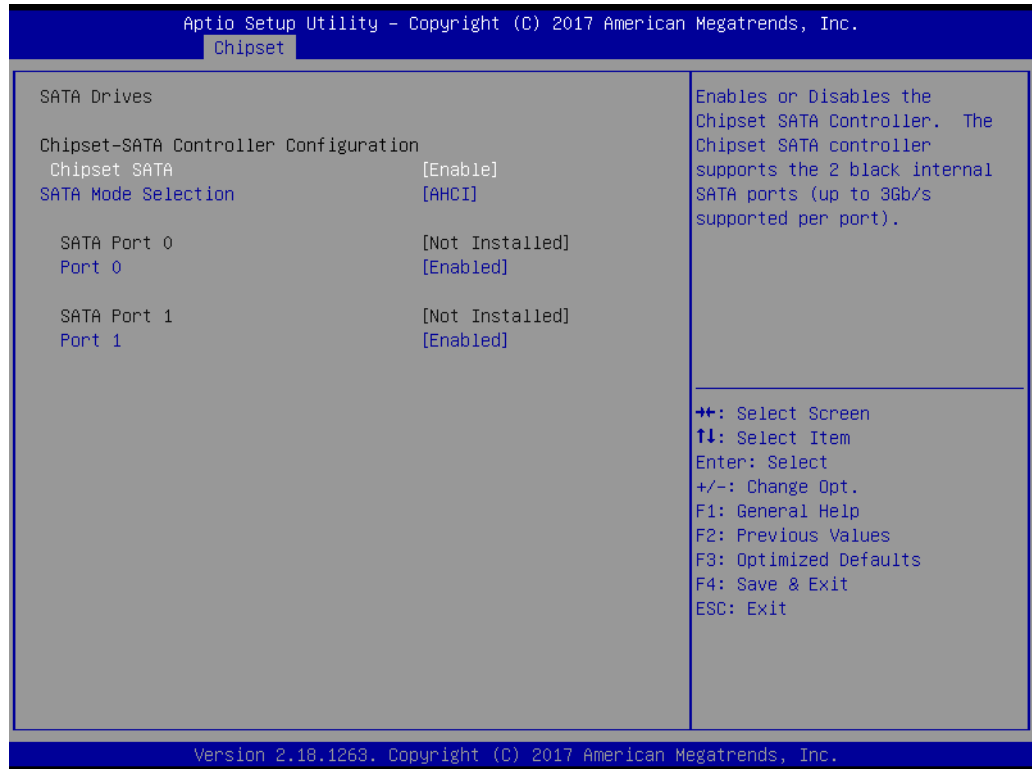

Figure 3.38 SATA Drives

- **Chipset SATA**
Enables or Disables the chipset SATA controller. The Chipset SATA controller supports the 2 black internal SATA ports (up to 3Gb/s supported per port)
- **SATA Mode Selection**
Determines how SATA controller(s) operate.
- **SATA Port 0**
Enable or Disable SATA Port.
- **SATA Port 1**
Enable or Disable SATA Port.

3.5.4.4 SCC Configuration

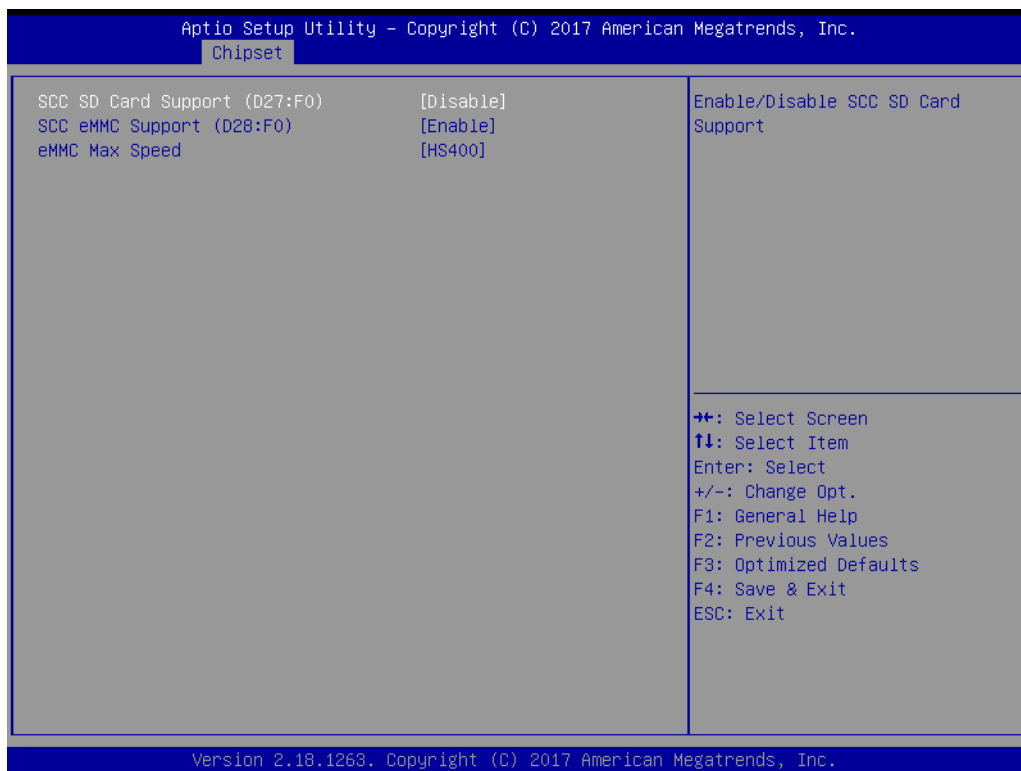

Figure 3.39 SCC Configuration

- **SCC SD Card Support (D27:F0)**
Enable/Disable SCC SD Card Support
- **SCC eMMC Support (D28:F0)**
Enable/Disable SCC eMMC Support
- **eMMC Max Speed**
Select the eMMC max Speed allowed.

3.5.4.5 USB Configuration

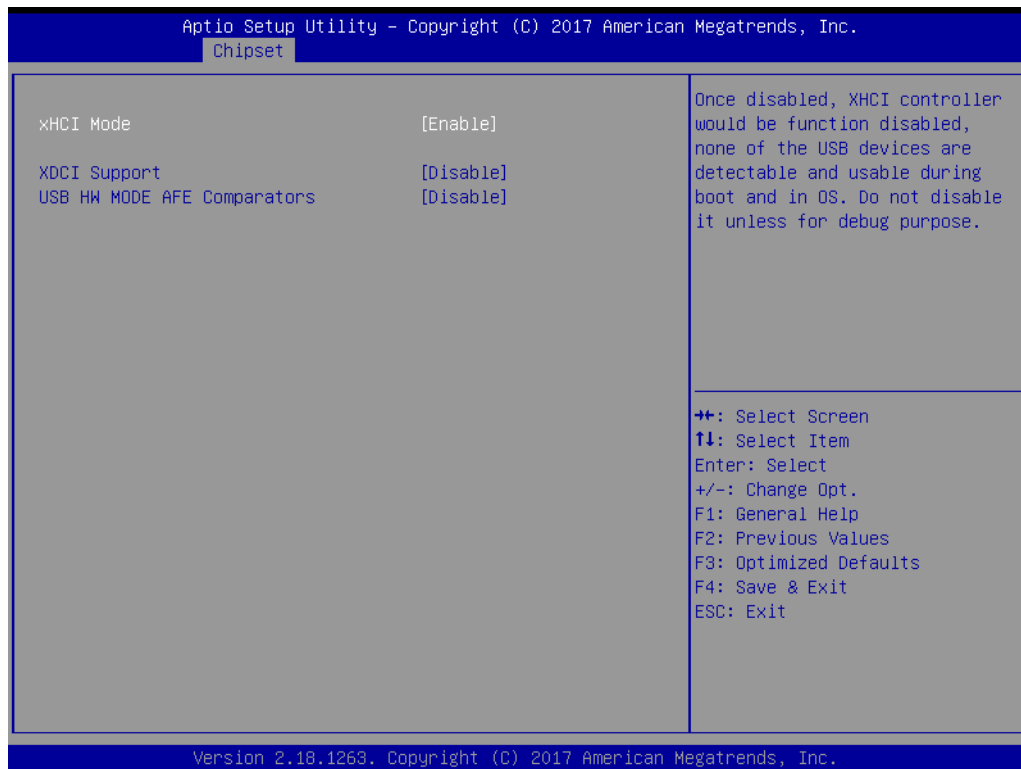

Figure 3.40 USB Configuration

- **xHCI Mode**
Once disabled, xHCI controller would be function disabled, none of the USB devices are detectable and usable during boot and in OS. Do not disable it unless for debug purpose.
- **XDCI Support**
Enable/Disable XDCI.
- **USB HW MODE AFE Comparators**
Enable/Disable USB HW MODE AFE Comparators.

3.5.4.6 Miscellaneous Configuration

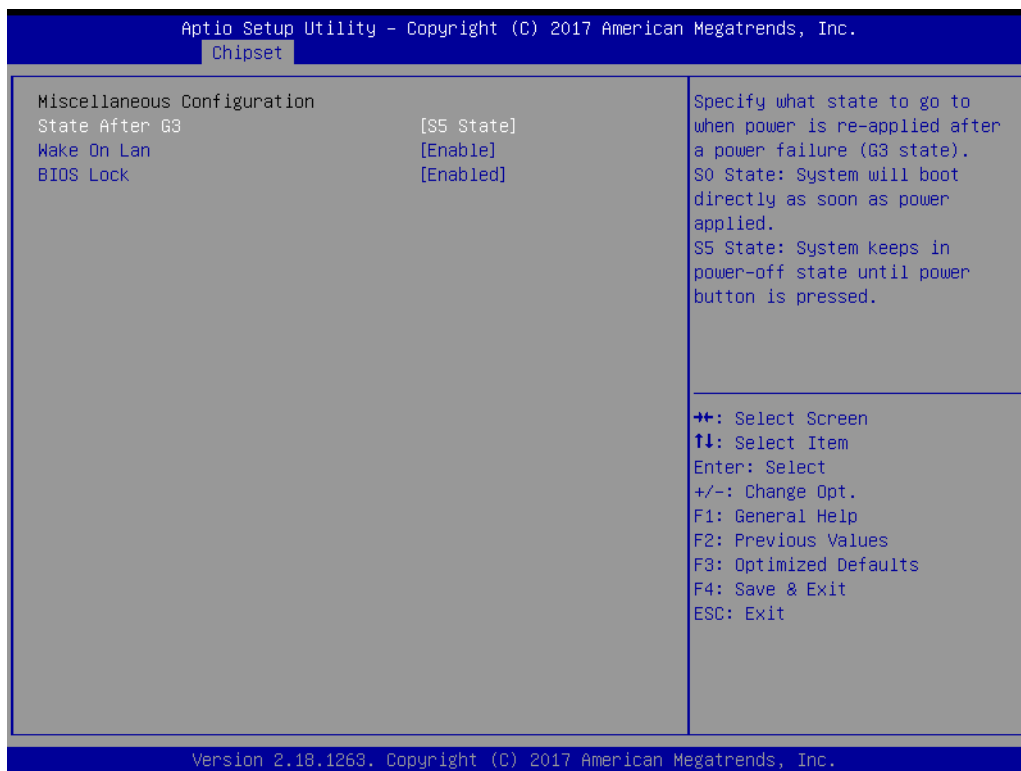

Figure 3.41 Miscellaneous Configuration

- **State After G3**
Specify what state to go to when power is re-applied after a power failure (G3 state).
S0 State: System will boot directly as soon as power applied.
S5 State: System keeps in power-off state until power button is pressed.
- **Wake On Lan**
Enable or Disable the Wake on Lan.
- **BIOS Lock**
Enable/Disable the SC BIOS Lock Enable features. Required to be enabled to ensure SMM protection of flash.

3.6 Security Setting

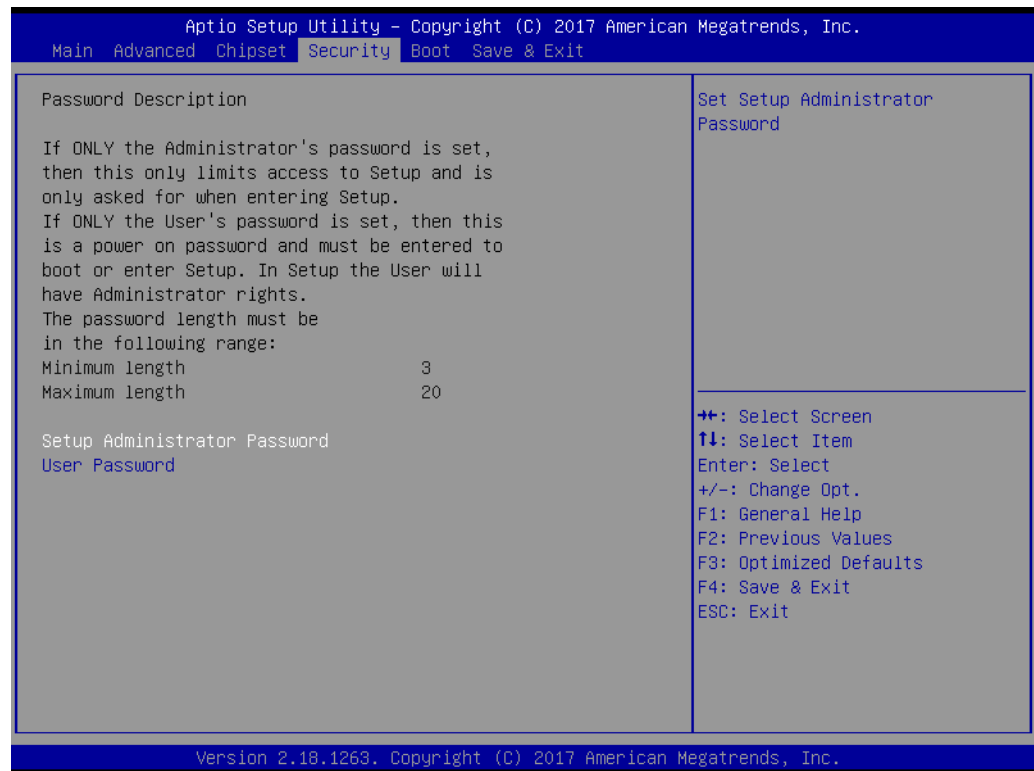

Figure 3.42 Security Setup

Select Security Setup from the SOM-7569 Setup main BIOS setup menu. All Security Setup options, such as password protection is described in this section. To access the sub menu for the following items, select the item and press <Enter>:

- **Change Administrator / User Password:**

Select this option and press <ENTER> to access the sub menu, and then type in the password.

3.7 Boot Settings

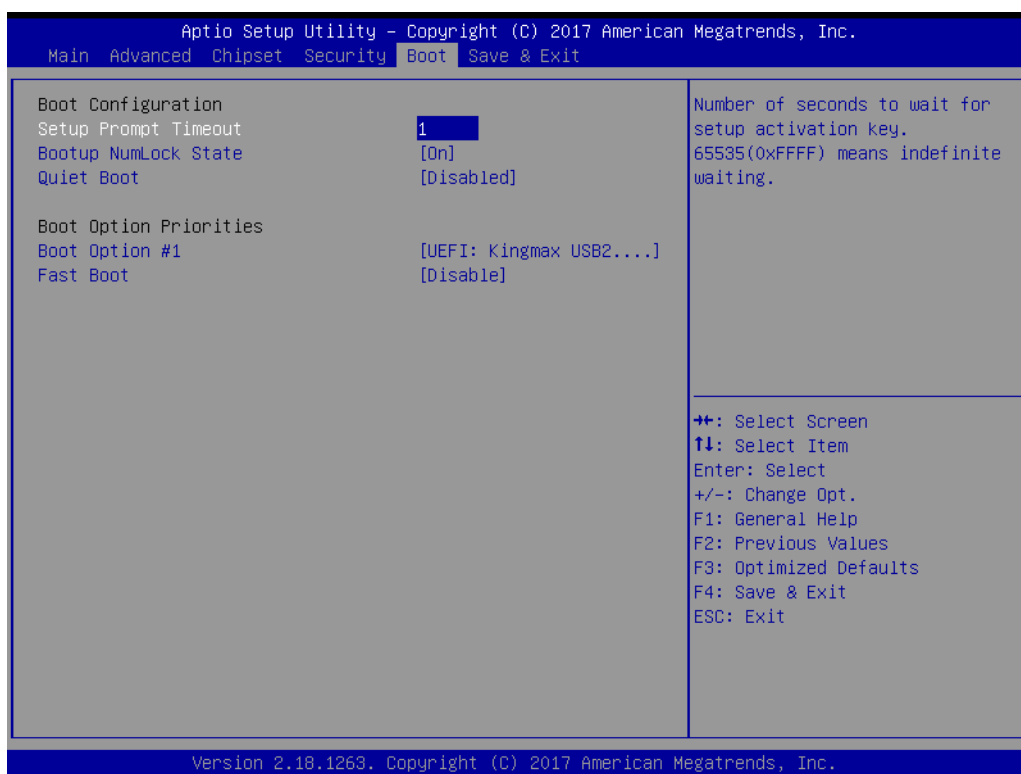

Figure 3.43 Boot Setting

- **Setup Prompt Timeout**
This item allows users to select the number of seconds to wait for setup activation key.
Number of seconds to wait for setup activation key.
65535(0xFFFF) means indefinite waiting.
- **Bootup NumLock State**
Select the keyboard Numlock state.
- **Quiet Boot**
Enable or Disables Quiet Boot option.
- **Fast Boot**
Enable or Disable FastBoot features. Most probes are skipped to reduce time cost during boot.

3.8 Save & Exit

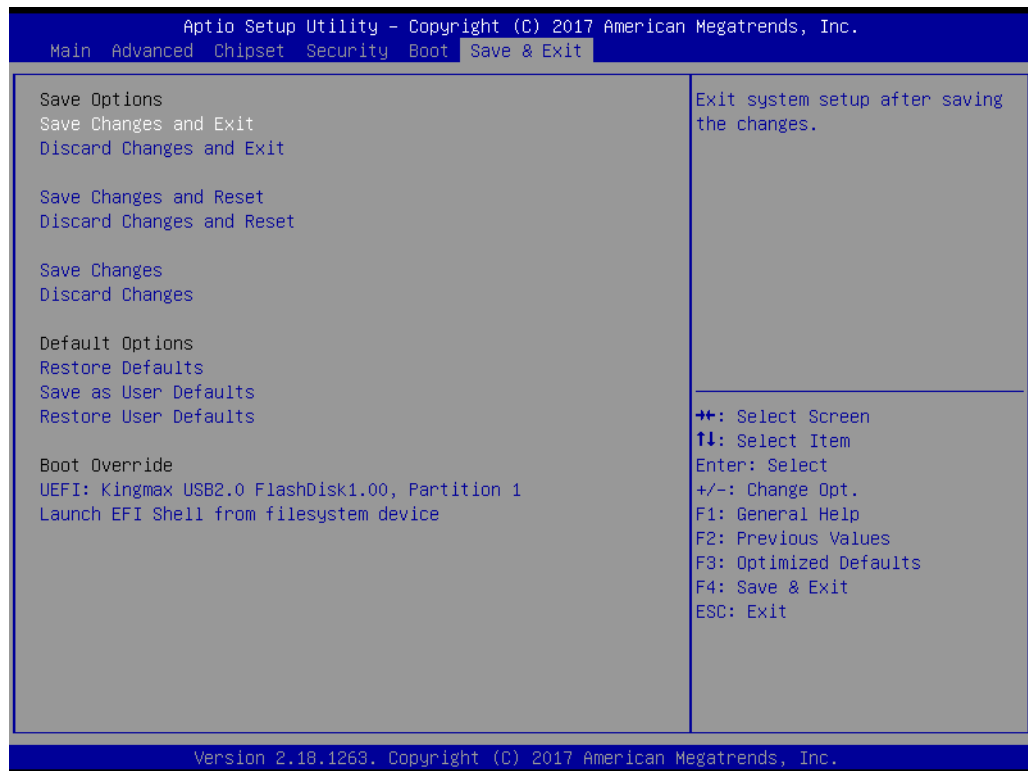

Figure 3.44 Save & Exit

- **Save Changes and Exit**
Exit system setup after saving the changes.
- **Discard Changes and Exit**
Exit system setup without saving any changes.
- **Save Changes and Reset**
Reset the system after saving the changes.
- **Discard Changes and Reset**
Reset system setup without saving any changes.
- **Save Changes**
Save Changes done so far to any of the setup options.
- **Discard Changes**
Discard Changes done so far to any of the setup options.
- **Restore Defaults**
Restore/Load Default values for all the setup options.
- **Save as User Defaults**
Save the changes done so far as User Defaults.
- **Restore User Defaults**
Restore the User Defaults to all the setup options
- **Launch EFI Shell from filesystem device**
Attempts to Launch EFI Shell application (Shell.efi) from one of the available file-system devices.

Chapter 4

S/W Introduction & Installation

Sections include:

- S/W Introduction
- Driver Installation
- Advantech iManager

4.1 S/W Introduction

The mission of Advantech Embedded Software Services is to "Enhance quality of life with Advantech platforms and Microsoft Windows embedded technology." We enable Windows Embedded software products on Advantech platforms to more effectively support the embedded computing community. Customers are freed from the hassle of dealing with multiple vendors (Hardware suppliers, System integrators, Embedded OS distributor) for projects. Our goal is to make Windows Embedded Software solutions easily and widely available to the embedded computing community.

4.2 Driver Installation

The Intel Chipset Software Installation (CSI) utility installs the Windows INF files that outline to the operating system how the chipset components will be configured.

4.2.1 Windows Driver Setup

To install the drivers on a windows-based operation system, please connect to internet and browse the website <http://support.advantech.com.tw> and download the drivers that you want to install and follow Driver Setup instructions to complete the installation.

4.2.2 Other OS

To install the drivers for Linux or other OS, please connect to internet and browse the website <http://support.advantech.com.tw> to download the setup file.

4.3 Advantech iManager

Advantech's platforms come equipped with iManager, a micro controller that provides embedded features for system integrators. Embedded features have been moved from the OS/BIOS level to the board level, to increase reliability and simplify integration. iManager runs whether the operating system is running or not; it can count the boot times and running hours of the device, monitor device health, and provide an advanced watchdog to handle errors just as they happen. iManager also comes with a secure & encrypted EEPROM for storing important security keys or other customer defined information. All embedded functions are configured through API and provide corresponding utilities to demonstrate. These APIs comply with PICMG EAPI (Embedded Application Programmable Interface) specification. This makes these embedded features easier to integrate, speed up development schedules, and provides software continuity while upgrading hardware. More details of how to use the APIs and utilities, please refer to Advantech iManager 2.0 Software API User Manual.

Control**GPIO**

General Purpose Input/Output is a flexible parallel interface that allows a variety of custom connections. It allows users to monitor the level of signal input or set the output status to switch on/off a device. Our API also provides Programmable GPIO, which allows developers to dynamically set the GPIO input or output status.

**SMBus**

SMBus is the System Management Bus defined by Intel® Corporation in 1995. It is used in personal computers and servers for low-speed system management communications. The SMBus API allows a developer to interface a embedded system environment and transfer serial messages using the SMBus protocols, allowing multiple simultaneous device control.

**I2C**

I2C is a bi-directional two wire bus that was developed by Philips for use in their televisions in the 1980s. The I2C API allows a developer to interface with an embedded system environment and transfer serial messages using the I2C protocols, allowing multiple simultaneous device control.

Display**Brightness Control**

The Brightness Control API allows a developer to interface with an embedded device to easily control brightness.

**Backlight**

The Backlight API allows a developer to control the backlight (screen) on/off in an embedded device.

Monitor**Watchdog**

A watchdog timer (WDT) is a device that performs a specific operation after a certain period of time if something goes wrong and the system does not recover on its own. A watchdog timer can be programmed to perform a warm boot (restarting the system) after a certain number of seconds.

**Hardware Monitor**

The Hardware Monitor (HWM) API is a system health supervision API that inspects certain condition indexes, such as fan speed, temperature and voltage.

**Hardware Control**

The Hardware Control API allows developers to set the PWM (Pulse Width Modulation) value to adjust fan speed or other devices; it can also be used to adjust the LCD brightness.

Power Saving**CPU Speed**

Make use of Intel SpeedStep technology to reduce power consumption. The system will automatically adjust the CPU Speed depending on system loading.

**System Throttling**

Refers to a series of methods for reducing power consumption in computers by lowering the clock frequency. These APIs allow the user to lower the clock from 87.5% to 12.5%.

Appendix **A**

Pin Assignments

This appendix gives you the information about the hardware pin assignment of the SOM-7569 COM Express Mini CPU Module.

Sections include:

- SOM-7569 Type 10 Pin Assignment

A.1 SOM-7569 Type 10 Pin Assignment

This section gives SOM-7569 pin assignment on COM Express connector which is compliant with COM.0 R 2.1 Type 10 pin-out definitions. For more details about how to use these pins and get a design reference guide, please contact Advantech for design guide, checklist, reference schematic, and other hardware/software support.

Table A.1: SOM-7569 Row A,B

A1	GND	B1	GND
A2	GBE0_MDI3-	B2	GBE0_ACT#
A3	GBE0_MDI3+	B3	LPC_FRAME#
A4	GBE0_LINK100#	B4	LPC_AD0
A5	GBE0_LINK1000#	B5	LPC_AD1
A6	GBE0_MDI2-	B6	LPC_AD2
A7	GBE0_MDI2+	B7	LPC_AD3
A8	GBE0_LINK#	B8	N/A
A9	GBE0_MDI1-	B9	N/A
A10	GBE0_MDI1+	B10	LPC_CLK
A11	GND	B11	GND
A12	GBE0_MDI0-	B12	PWRBTN#
A13	GBE0_MDI0+	B13	SMB_CK
A14	N/A	B14	SMB_DAT
A15	SUS_S3#	B15	SMB_ALERT#
A16	SATA0_TX+	B16	SATA1_TX+
A17	SATA0_TX-	B17	SATA1_TX-
A18	SUS_S4#	B18	SUS_STAT#
A19	SATA0_RX+	B19	SATA1_RX+
A20	SATA0_RX-	B20	SATA1_RX-
A21	GND	B21	GND
A22	USB_SSRX0-	B22	USB_SSTX0-
A23	USB_SSRX0+	B23	USB_SSTX0+
A24	SUS_S4#	B24	PWR_OK
A25	USB_SSRX1-	B25	USB_SSTX1-
A26	USB_SSRX1+	B26	USB_SSTX1+
A27	BATLOW#	B27	WDT
A28	(S)ATA_ACT#	B28	N/A
A29	AC/HDA_SYNC	B29	N/A
A30	AC/HDA_RST#	B30	AC/HDA_SDIN0
A31	GND	B31	GND
A32	AC/HDA_BITCLK	B32	SPKR
A33	AC/HDA_SDOUT	B33	I2C_CK
A34	BIOS_DIS0#	B34	I2C_DAT
A35	THRMTRIP#	B35	THRM#
A36	USB6-	B36	USB7-
A37	USB6+	B37	USB7+
A38	USB_6_7_OC#	B38	USB_4_5_OC#
A39	USB4-	B39	USB5-
A40	USB4+	B40	USB5+

Table A.1: SOM-7569 Row A,B			
A41	GND	B41	GND
A42	USB2-	B42	USB3-
A43	USB2+	B43	USB3+
A44	USB_2_3_OC#	B44	USB_0_1_OC#
A45	USB0-	B45	USB1-
A46	USB0+	B46	USB1+
A47	VCC_RTC	B47	EXCD1_PERST#
A48	EXCD0_PERST#	B48	EXCD1_CPPE#
A49	EXCD0_CPPE#	B49	SYS_RESET#
A50	LPC_SERIRQ	B50	CB_RESET#
A51	GND	B51	GND
A52	N/A	B52	N/A
A53	N/A	B53	N/A
A54	GPI0	B54	GPO1
A55	N/A	B55	N/A
A56	N/A	B56	N/A
A57	GND	B57	GPO2
A58	PCIE_TX3+	B58	PCIE_RX3+
A59	PCIE_TX3-	B59	PCIE_RX3-
A60	GND	B60	GND
A61	PCIE_TX2+	B61	PCIE_RX2+
A62	PCIE_TX2-	B62	PCIE_RX2-
A63	GPI1	B63	GPO3
A64	PCIE_TX1+	B64	PCIE_RX1+
A65	PCIE_TX1-	B65	PCIE_RX1-
A66	GND	B66	WAKE0#
A67	GPI2	B67	WAKE1#
A68	PCIE_TX0+	B68	PCIE_RX0+
A69	PCIE_TX0-	B69	PCIE_RX0-
A70	GND	B70	GND
A71	LVDS_A0+	B71	DDIO_PAIR0+
A72	LVDS_A0-	B72	DDIO_PAIR0-
A73	LVDS_A1+	B73	DDIO_PAIR1+
A74	LVDS_A1-	B74	DDIO_PAIR1-
A75	LVDS_A2+	B75	DDIO_PAIR2+
A76	LVDS_A2-	B76	DDIO_PAIR2-
A77	LVDS_VDD_EN	B77	N/A
A78	LVDS_A3+	B78	N/A
A79	LVDS_A3-	B79	LVDS_BKLT_EN
A80	GND	B80	GND
A81	LVDS_A_CK+	B81	DDIO_PAIR3+
A82	LVDS_A_CK-	B82	DDIO_PAIR3-
A83	LVDS_I2C_CK	B83	LVDS_BKLT_CTRL
A84	LVDS_I2C_DAT	B84	VCC_5V_SBY
A85	GPI3	B85	VCC_5V_SBY
A86	RSVD	B86	VCC_5V_SBY
A87	N/A	B87	VCC_5V_SBY

Table A.1: SOM-7569 Row A,B

A88	PCIE_CLK_REF+	B88	BIOS_DIS1#
A89	PCIE_CLK_REF-	B89	DDIO_HPD
A90	GND	B90	GND
A91	SPI_POWER	B91	N/A
A92	SPI_MISO	B92	N/A
A93	GPO0	B93	N/A
A94	SPI_CLK	B94	N/A
A95	SPI_MOSI	B95	DDIO_DDC_AUX_SEL
A96	TPM_PP	B96	RSVD
A97	TYPE10#	B97	SPI_CS#
A98	SER0_TX	B98	DDIO_CTRLCLK_AUX+
A99	SER0_RX	B99	DDIO_CTRLCLK_AUX-
A100	GND	B100	GND
A101	SER1_TX	B101	FAN_PWMOUT
A102	SER1_RX	B102	FAN_TACHIN
A103	LID#	B103	SLEEP#
A104	VCC_12V	B104	VCC_12V
A105	VCC_12V	B105	VCC_12V
A106	VCC_12V	B106	VCC_12V
A107	VCC_12V	B107	VCC_12V
A108	VCC_12V	B108	VCC_12V
A109	VCC_12V	B109	VCC_12V
A110	GND	B110	GND

Appendix **B**

Watchdog Timer

This appendix gives you the information about the watchdog timer programming on the SOM-7569 COM Express Mini CPU Module. Sections include:

- Watchdog Timer Programming

B.1 Programming the Watchdog Timer

Trigger Event	Note
IRQ	IRQ5, 7, 14 (BIOS setting default disable)**
NMI	N/A
SCI	Power button event
Power Off	Support
H/W Restart	Support
WDT Pin Activate	Support

** WDT new driver support automatically select available IRQ number from BIOS, and then set to EC. Only Win10 support it.

In other OS, it will still use IRQ number from BIOS setting as usual.

For details, please refer to iManager & Software API User Manual.

Appendix **C**

Programming GPIO

This Appendix gives the illustration of the General Purpose Input and Output pin setting.

Sections include:

- System I/O ports

C.1 GPIO Register

GPIO Byte Mapping	H/W Pin Name
BIT0	GPO0
BIT1	GPO1
BIT2	GPO2
BIT3	GPO3
BIT4	GPI0
BIT5	GPI1
BIT6	GPI2
BIT7	GPI3

For details, please refer to iManager & Software API User Manual.

Appendix **D**

System Assignments

This appendix gives you the information about the system resource allocation on the SOM-7569 COM Express Mini CPU Module.

Sections include:

- System I/O ports
- Interrupt Assignments
- 1st MB Memory Map

D.1 System I/O Ports

Table D.1: System I/O ports

Addr.Range(Hex)	Device
0000-006F	PCI Express Root Complex
0020-0021	Programmable interrupt controller
0024-0025	Programmable interrupt controller
0028-0029	Programmable interrupt controller
002C-002D	Programmable interrupt controller
002E-002F	Motherboard resources
0030-0031	Programmable interrupt controller
0034-0035	Programmable interrupt controller
0038-0039	Programmable interrupt controller
003C-003D	Programmable interrupt controller
0040-0043	System timer
004E-004F	Motherboard resources
0050-0053	System timer
0060-006F	Motherboard resources
0061-0061	Motherboard resources
0062-0062	Microsoft ACPI-Compliant Embedded Controller
0063-0063	Motherboard resources
0065-0065	Motherboard resources
0066-0066	Microsoft ACPI-Compliant Embedded Controller
0067-0067	Motherboard resources
0070-0070	Motherboard resources
0070-0077	System CMOS/real time clock
0078-0CF7	PCI Express Root Complex
0080-008F	Motherboard resources
0092-0092	Motherboard resources
00A0-00A1	Programmable interrupt controller
00A4-00A5	Programmable interrupt controller
00A8-00A9	Programmable interrupt controller
00AC-00AD	Programmable interrupt controller
00B0-00B1	Programmable interrupt controller
00B2-00B3	Motherboard resources
00B4-00B5	Programmable interrupt controller
00B8-00B9	Programmable interrupt controller
00BC-00BD	Programmable interrupt controller
0280-028F	Motherboard resources
0290-029F	Motherboard resources
0299-029A	Motherboard resources
029E-02AD	Motherboard resources
02A0-02BF	Motherboard resources
02C0-02DF	Motherboard resources
02E8-02EF	Communications Port (COM4)
02F0-02E7	Motherboard resources
02F8-02FF	Communications Port (COM2)

Table D.1: System I/O ports

Addr.Range(Hex)	Device
0378-037F	Printer Port (LPT1)
03E8-03EF	Communications Port (COM3)
03F8-03FF	Communications Port (COM1)
0400-047F	Motherboard resources
04D0-04D1	Programmable interrupt controller
0500-05EF	Motherboard resources
0600-061F	Motherboard resources
0680-069F	Motherboard resources
0D00-FFFF	PCI Express Root Complex
164E-164F	Motherboard resources
E000-EFFF	Intel(R) Celeron(R)/Pentium(R)Processor PCI Express Root Port – 5AD7
F000-F03F	Intel(R) HD Graphics
F040-F05F	Intel(R) Celeron(R)/Pentium(R) Processor SMBus - 5AD4
F060-F07F	Standard SATA AHCI Controller
F080-F083	Standard SATA AHCI Controller
F090-F097	Standard SATA AHCI Controller

D.2 Interrupt Assignments

Table D.2: Interrupt Assignments

Interrupt#	Interrupt Source
IRQ 0	System timer
IRQ 3	Communications Port (COM2)
IRQ 4	Communications Port (COM1)
IRQ 5	Communications Port (COM4)
IRQ 6	Communications Port (COM3)
IRQ 8	System CMOS/real time clock
IRQ 14	GPIO Controller
IRQ 54~511	Microsoft ACPI-Compliant System
IRQ 25	High Definition Audio Controller
IRQ 39	SDA Standard Compliant SD Host Controller
IRQ FFFFFFFF0 (-16)	Intel® USB 3.0 eXtensible Host Controller - 1.0(Microsoft)
IRQ FFFFFFFF1 (-15)~ IRQ FFFFFFFF6 (-10)~	Intel(R) I210 Gigabit Network Connection
IRQ FFFFFFFF7 (-9)	Intel® Trusted Execution Engine Interface
IRQ FFFFFFFF8 (-8)	Intel(R) HD Graphics
IRQ FFFFFFFF9 (-7)	Standard SATA AHCI Controller
IRQ FFFFFFFFA (-6)	Intel(R) Celeron(R)/Pentium(R)Processor PCI Express Root Port – 5AD7
IRQ FFFFFFFFB (-5)	Intel(R) Celeron(R)/Pentium(R)Processor PCI Express Root Port – 5ADB
IRQ FFFFFFFFC (-4)	Intel(R) Celeron(R)/Pentium(R)Processor PCI Express Root Port – 5ADA
IRQ FFFFFFFFD (-3)	Intel(R) Celeron(R)/Pentium(R)Processor PCI Express Root Port – 5AD9
IRQ FFFFFFFFE (-2)	Intel(R) Celeron(R)/Pentium(R)Processor PCI Express Root Port – 5AD8

D.3 1st MB Memory Map

Table D.3: 1st MB Memory Map	
Addr. Range (Hex)	Device
0xA0000-0xBFFFF	PCI Express Root Complex
0xC0000-0xDFFFF	PCI Express Root Complex
0xE0000-0xFFFFF	PCI Express Root Complex
0x7B800001-0x7BFFFFFF	PCI Express Root Complex
0x7C000001-0x7CFFFFFF	PCI Express Root Complex
0x80000000-0x80FFFFFF	Intel(R) HD Graphics
0x81100000-0x813FFFFF	Intel(R) Celeron(R)/Pentium(R)Processor PCI Express Root Port – 5AD7
0x81200000-0x812FFFFF	Intel(R) I210 Gigabit Network Connection
0x81300000-0x81303FFF	Intel(R) I210 Gigabit Network Connection
0x81400000-0x8140FFFF	Intel® USB 3.0 eXtensible Host Controller - 1.0(Microsoft)
0x81410000-0x81413FFF	High Definition Audio Controller
0x81414000-0x81415FFF	Standard SATA AHCI Controller
0x81416000-0x814160FF	Intel(R) Celeron(R)/Pentium(R) Processor SMBUS – 5AD4
0x81417000-0x81417FFF	SDA Standard Compliant SD Host Controller
0x81418000-0x81418FFF	SDA Standard Compliant SD Host Controller
0x81419000-0x814197FF	Standard SATA AHCI Controller
0x8141A000-0x8141A0FF	Standard SATA AHCI Controller
0x8141D000-0x8141DFFF	Intel(R) Trusted Execution Engine Interface
0x90000000-0x9FFFFFFF	Intel(R) HD Graphics
0xD0C00000-0xD0C00653	GPIO Controller
0xE0000000-0xEFFFFFFF	Motherboard resources
0xE0000000-0xEFFFFFFF	PCI Express Root Complex
0xFE000000-0xFE000000	Motherboard resources
0xFED00000-0xFED003FF	High precision even timer
0xFED01000-0xFED01FFF	Motherboard resources
0xFED03000-0xFED03FFF	Motherboard resources
0xFED06000-0xFED06FFF	Motherboard resources
0xFED08000-0xFED09FFF	Motherboard resources
0xFED1C000-0xFED1CFFF	Motherboard resources
0xFED80000-0xFEDBFFFF	Motherboard resources
0xFEE00000-0xFEE00000	Motherboard resources

ADVANTECH

Enabling an Intelligent Planet

www.advantech.com

Please verify specifications before quoting. This guide is intended for reference purposes only.

All product specifications are subject to change without notice.

No part of this publication may be reproduced in any form or by any means, electronic, photocopying, recording or otherwise, without prior written permission of the publisher.

All brand and product names are trademarks or registered trademarks of their respective companies.

© Advantech Co., Ltd. 2017