

QTLP601C-R Red

QTLP601C-E Orange

QTLP601C-O Yellow-Orange

QTLP601C-Y Yellow

QTLP601C-AG Yellow-Green

QTLP601C-IG True Green

QTLP601C-IB Blue

PACKAGE DIMENSIONS

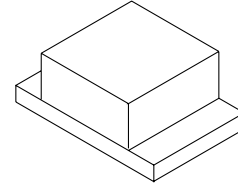
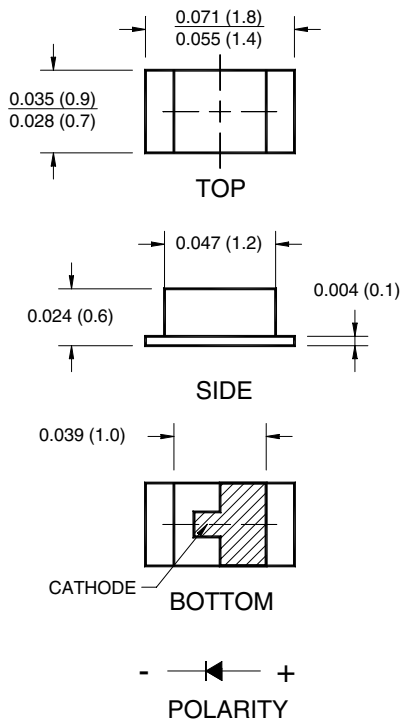

NOTE:

Dimensions for all drawings are in inches (mm).

APPLICATIONS

- Keypad backlighting
- Push-button backlighting
- LCD backlighting

DESCRIPTION

These surface mount chip LEDs are designed to fit industry standard footprint. Small size, low profile and wide viewing angle make these LEDs ideal choices for backlighting applications and panel illumination.

FEATURES

- Small footprint - 1.6(L) X 0.8(W) X 0.6(H) mm
- AllnGaP technology for -R, -E, -O, -Y and -AG
- InGaN/SiC technology for -IG and -IB
- Wide viewing angle of 120°
- Water clear optics
- Moisture-proof packaging
- Available in 0.315" (8mm) width tape on 7" (178mm) diameter reel; 2,000 units per reel

SURFACE MOUNT LED LAMP

SUPER BRIGHT 0603 (0.6 mm Height)

QTLP601C-R Red

QTLP601C-E Orange

QTLP601C-O Yellow-Orange

QTLP601C-Y Yellow

QTLP601C-AG Yellow-Green

QTLP601C-IG True Green

QTLP601C-IB Blue

ABSOLUTE MAXIMUM RATINGS (T_A =25°C Unless otherwise specified)

Parameter	Symbol	QTLP601C					Units
		-R	-E	-O	-Y	-AG	
Continuous Forward Current	I _F	30	30	30	25	30	mA
Peak Forward Current (f = 1.0 KHz, Duty Factor = 1/10)	I _{FM}	160	160	160	120	160	mA
Reverse Voltage	V _R	5	5	5	5	5	V
Power Dissipation	P _D	72	72	72	60	72	mW
Operating Temperature	T _{OPR}	-40 to +85					°C
Storage Temperature	T _{STG}	-40 to +90					°C
Lead Soldering Time	T _{SOL}	260 for 5 sec					°C

ABSOLUTE MAXIMUM RATINGS (T_A =25°C Unless otherwise specified)

Parameter	Symbol	QTLP601C		Units
		-IB	-IG	
Continuous Forward Current	I _F	30	30	mA
Peak Forward Current (f = 1.0 KHz, Duty Factor = 1/10)	I _{FM}	100	100	mA
Reverse Voltage	V _R	5	5	V
Power Dissipation	P _D	120	120	mW
Operating Temperature	T _{OPR}	-40 to +85		°C
Storage Temperature	T _{STG}	-40 to +90		°C
Lead Soldering Time	T _{SOL}	260 for 5 sec		°C

SURFACE MOUNT LED LAMP

SUPER BRIGHT 0603 (0.6 mm Height)

QTLP601C-R Red

QTLP601C-E Orange

QTLP601C-O Yellow-Orange

QTLP601C-Y Yellow

QTLP601C-AG Yellow-Green

QTLP601C-IG True Green

QTLP601C-IB Blue

ELECTRICAL / OPTICAL CHARACTERISTICS (T_A =25°C)

Part Number	Symbol	QTLP601C					Condition
		-R	-E	-O	-Y	-AG	
Luminous Intensity (mcd)	I _v	15	15	15	15	10	I _F = 20mA
Minimum		35	35	35	35	15	
Typical							
Forward Voltage (V)	V _F	2.4	2.4	2.4	2.4	2.4	I _F = 20mA
Maximum		2.0	2.0	2.0	2.0	2.0	
Typical							
Wavelength (nm)	λ _P	630	620	610	590	575	I _F = 20mA
Peak		624	615	605	589	573	
Dominant	λ _D						
Spectral Line Half Width (nm)	Δλ	20	18	18	15	20	I _F = 20mA
Viewing Angle (°)	2Θ _{1/2}	120	120	120	120	120	I _F = 20mA

ELECTRICAL / OPTICAL CHARACTERISTICS (T_A =25°C)

Part Number	Symbol	QTLP601C		Condition
		-IB	-IG	
Luminous Intensity (mcd)	I _v	15	50	I _F = 20mA
Minimum		25	70	
Typical				
Forward Voltage (V)	V _F	4.0	4.0	I _F = 20mA
Maximum		3.5	3.5	
Typical				
Wavelength (nm)	λ _P	465	520	I _F = 20mA
Peak		470	525	
Dominant	λ _D			
Spectral Line Half Width (nm)	Δλ	25	35	I _F = 20mA
Viewing Angle (°)	2Θ _{1/2}	120	120	I _F = 20mA

QTLP601C-R Red

QTLP601C-E Orange

QTLP601C-O Yellow-Orange

QTLP601C-Y Yellow

QTLP601C-AG Yellow-Green

QTLP601C-IG True Green

QTLP601C-IB Blue

TYPICAL PERFORMANCE CURVES (QTLP601C-R, -E, -O, -Y and -AG)

Fig. 1 Forward Current vs. Forward Voltage

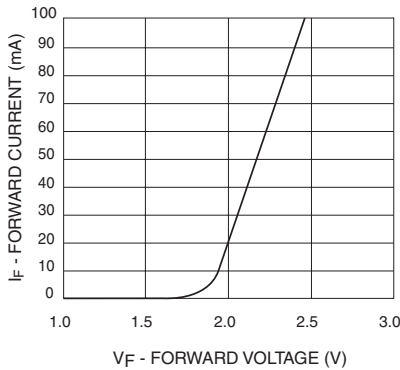

Fig. 2 Relative Luminous Intensity vs. DC Forward Current

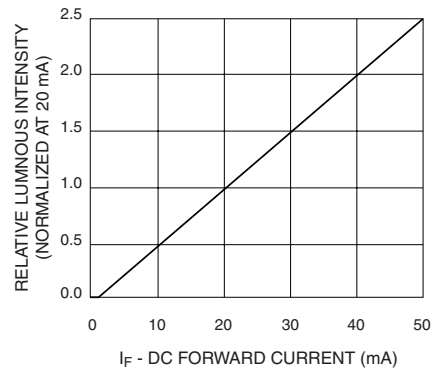

Fig. 3 Relative Intensity vs. Peak Wavelength

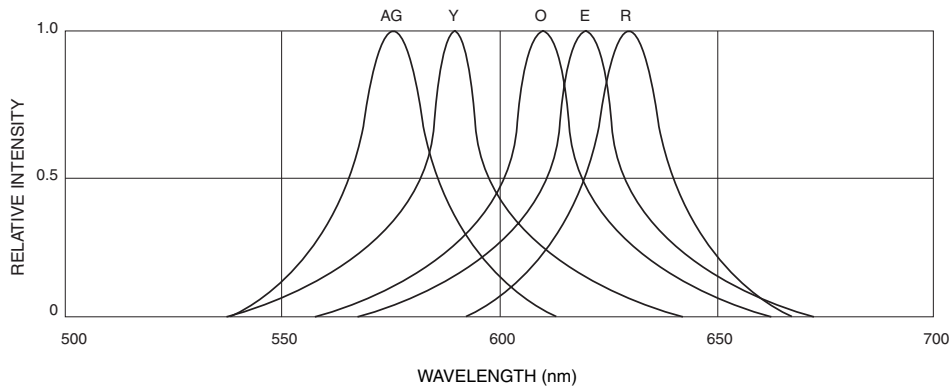

Fig.4 Radiation Diagram

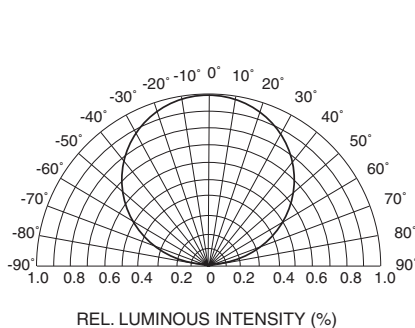
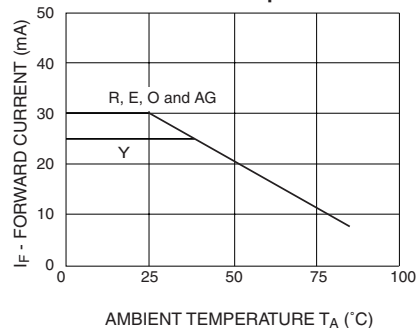

Fig.5 Maximum Forward Current vs. Ambient Temperature



QTLP601C-R Red

QTLP601C-E Orange

QTLP601C-O Yellow-Orange

QTLP601C-Y Yellow

QTLP601C-AG Yellow-Green

QTLP601C-IG True Green

QTLP601C-IB Blue

TYPICAL PERFORMANCE CURVES (QTLP601C-IG and IB)

Fig. 1 Forward Current vs. Forward Voltage

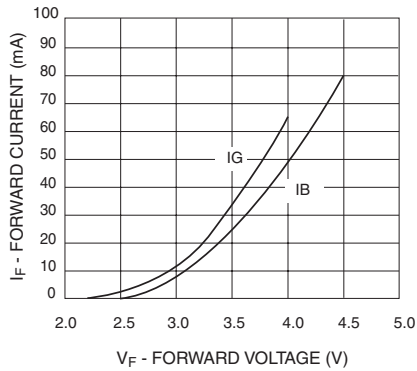

Fig. 2 Relative Luminous Intensity vs. DC Forward Current

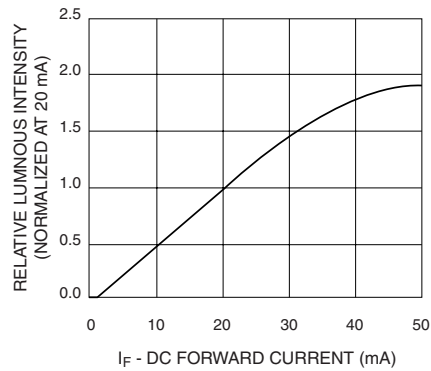

Fig. 3 Relative Intensity vs. Peak Wavelength

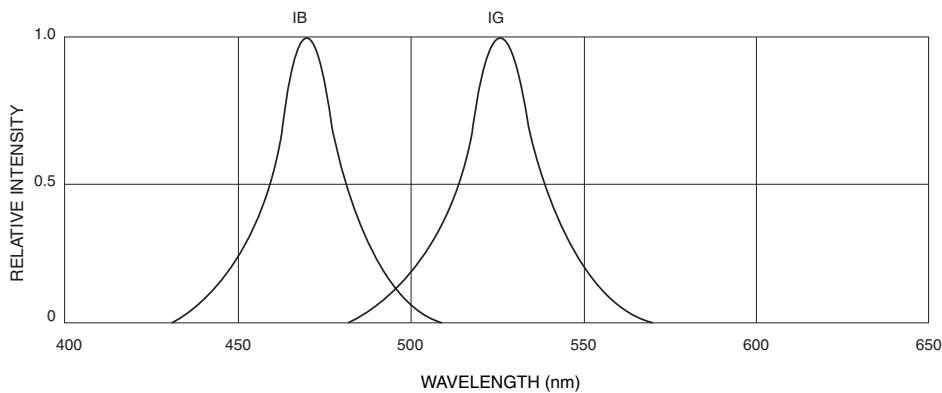

Fig. 4 Radiation Diagram

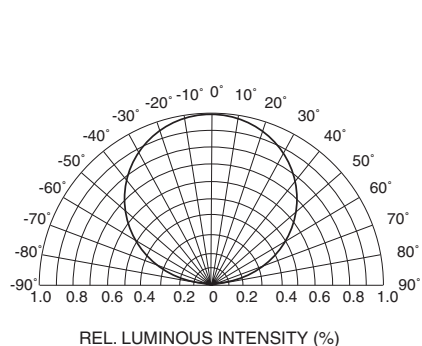
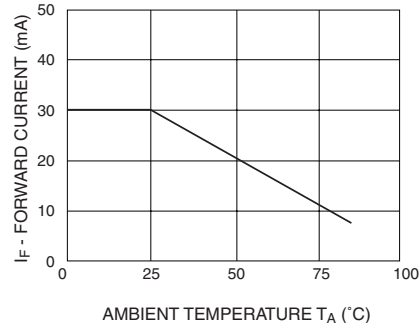

Fig. 5 Maximum Forward Current vs. Ambient Temperature



SURFACE MOUNT LED LAMP SUPER BRIGHT 0603 (0.6 mm Height)

QTLP601C-R Red

QTLP601C-E Orange

QTLP601C-O Yellow-Orange

QTLP601C-Y Yellow

QTLP601C-AG Yellow-Green

QTLP601C-IG True Green

QTLP601C-IB Blue

RECOMMENDED PRINTED CIRCUIT BOARD PATTERN

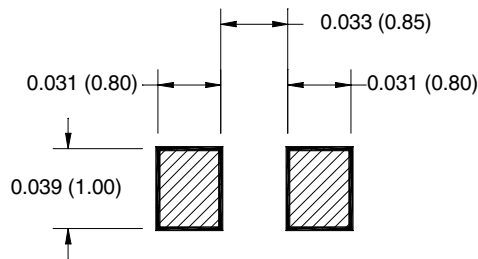

RECOMMENDED IR REFLOW SOLDERING PROFILE

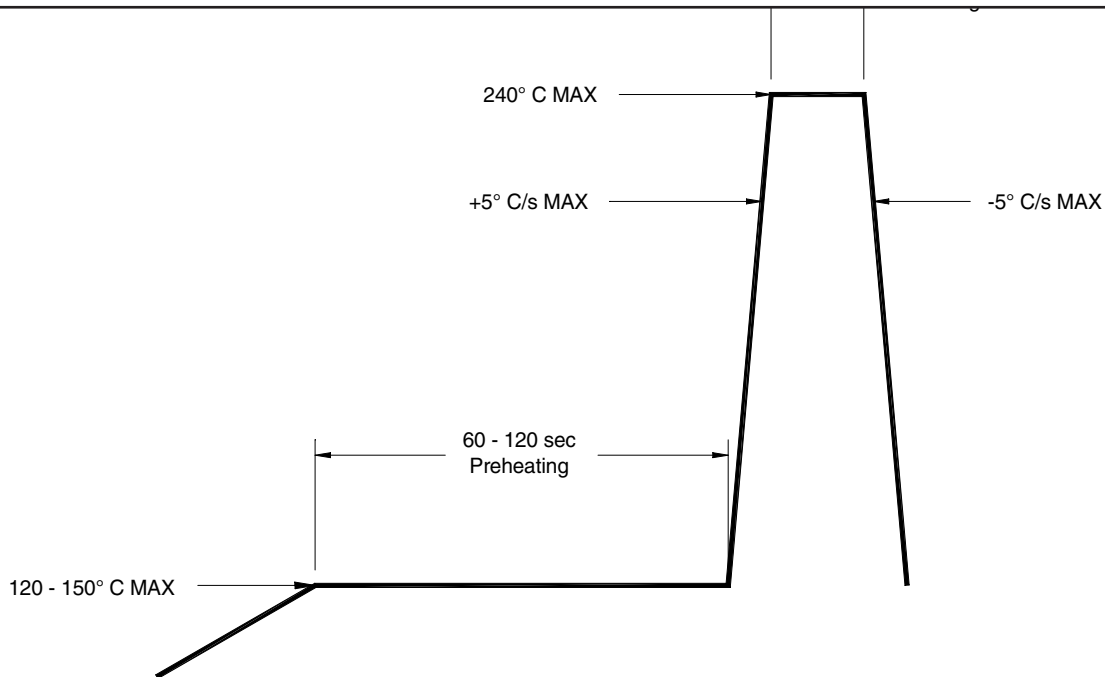

QTLP601C-R Red

QTLP601C-E Orange

QTLP601C-O Yellow-Orange

QTLP601C-Y Yellow

QTLP601C-AG Yellow-Green

QTLP601C-IG True Green

QTLP601C-IB Blue

TAPE AND REEL DIMENSIONS

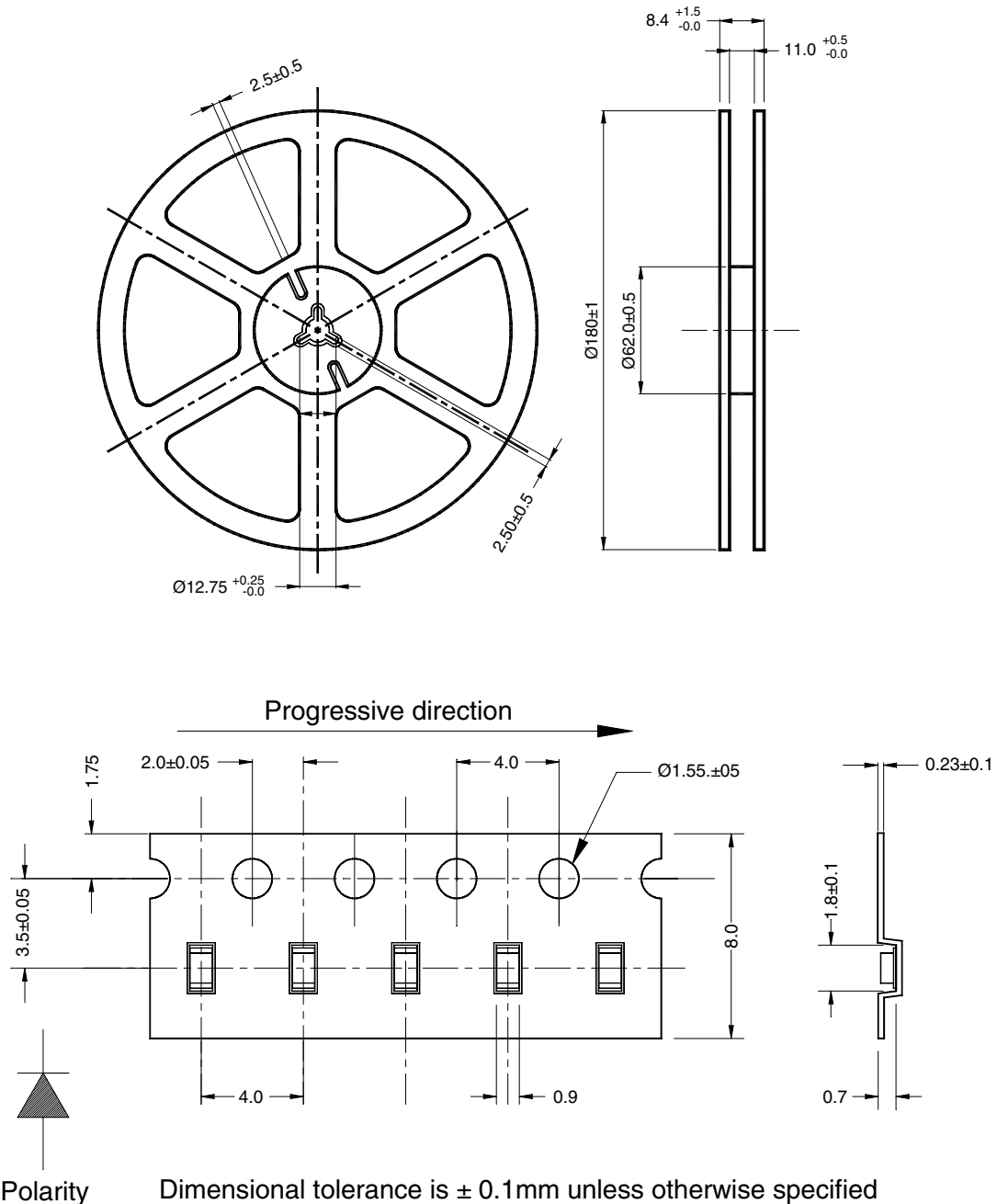

QTLP601C-R Red

QTLP601C-E Orange

QTLP601C-O Yellow-Orange

QTLP601C-Y Yellow

QTLP601C-AG Yellow-Green

QTLP601C-IG True Green

QTLP601C-IB Blue

DISCLAIMER

FAIRCHILD SEMICONDUCTOR RESERVES THE RIGHT TO MAKE CHANGES WITHOUT FURTHER NOTICE TO ANY PRODUCTS HEREIN TO IMPROVE RELIABILITY, FUNCTION OR DESIGN. FAIRCHILD DOES NOT ASSUME ANY LIABILITY ARISING OUT OF THE APPLICATION OR USE OF ANY PRODUCT OR CIRCUIT DESCRIBED HEREIN; NEITHER DOES IT CONVEY ANY LICENSE UNDER ITS PATENT RIGHTS, NOR THE RIGHTS OF OTHERS.

LIFE SUPPORT POLICY

FAIRCHILD'S PRODUCTS ARE NOT AUTHORIZED FOR USE AS CRITICAL COMPONENTS IN LIFE SUPPORT DEVICES OR SYSTEMS WITHOUT THE EXPRESS WRITTEN APPROVAL OF THE PRESIDENT OF FAIRCHILD SEMICONDUCTOR CORPORATION. As used herein:

1. Life support devices or systems are devices or systems which, (a) are intended for surgical implant into the body, or (b) support or sustain life, and (c) whose failure to perform when properly used in accordance with instructions for use provided in labeling, can be reasonably expected to result in a significant injury of the user.
2. A critical component in any component of a life support device or system whose failure to perform can be reasonably expected to cause the failure of the life support device or system, or to affect its safety or effectiveness.