

### POWER MANAGEMENT

#### Features

- Input Voltage Range – 1.6V to 5.5V
- 2A Continuous Output Current
- Ultra Low Ron – 32mΩ
- Reverse Current Blocking
- Low Quiescent Current – 1μA
- Low Shutdown Current – 0.3μA
- Internal Soft Start
- Hardened ESD Protection 4kV
- Package: CSP – 0.9mm x 0.9mm 4-Bump
- AEC-Q100 Qualified (Grade3) Version Available

#### Applications

- Wearable Electronics
- Tablet PCs, eReaders
- Smartphones
- Notebook PCs, Ultrabooks
- Battery Powered Equipment
- Other Portable Devices

#### Description

The SC33020H/HQ is an integrated 2A Load Switch with reverse current blocking. It operates from an 1.6V to 5.5V input supply. The SC33020H/HQ leaves the output node floating when the part is disabled.

The device provides extremely low 32mOhm ON resistance ( $R_{ON}$ ) in an ultra-small package. The reverse blocking feature prevents current from flowing in reverse direction from the output through the device to the input supply rail. Whenever Vout to VIN voltage exceeds the reverse blocking threshold, reverse blocking is activated regardless of the IC enable state either (ON or OFF).

The SC33020H/HQ is offered in a tiny 0.9mm x 0.9mm x 0.60mm, 4 Bump CSP package. The SC33020H/HQ has an operating temperature range of -40°C to +85 °C.

The SC33020HQ is an AEC-Q100 (Grade3)qualified version.

#### Typical Application Circuit

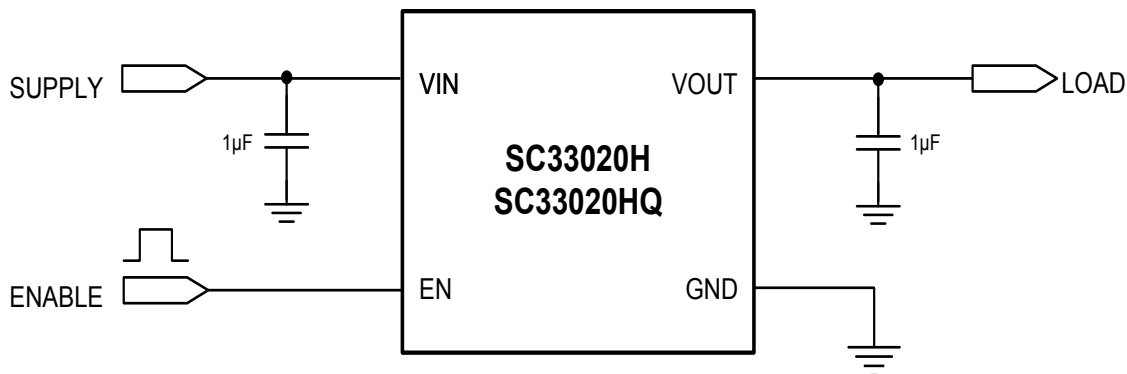

### Pin Configuration

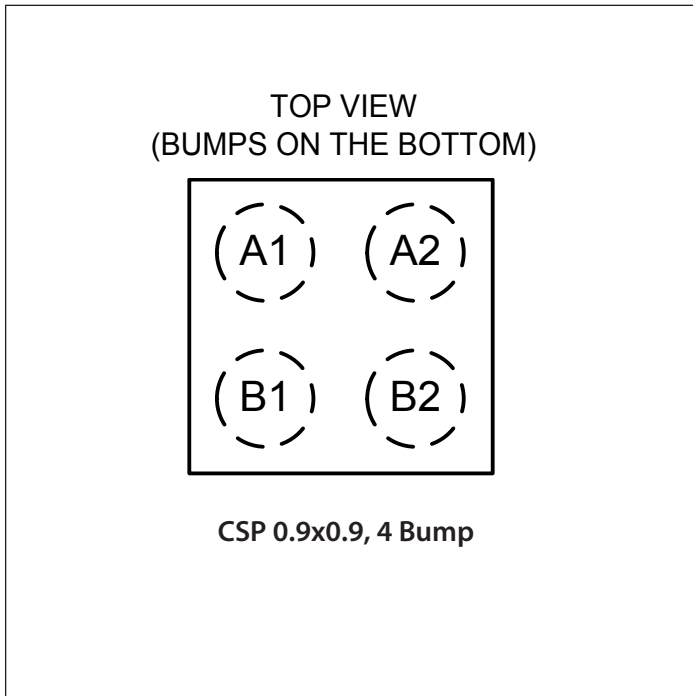

### Ordering Information

Device	Package
SC33020HCSTRT <sup>(1)(2)</sup>	CSP 0.9mm x 0.9mm 4-bump
SC33020HQCSTRT <sup>(1)(2)(3)</sup>	CSP 0.9mm x 0.9mm 4-bump
SC33020HCSEVB	Evaluation Board
SC33020HQCSEVB	Evaluation Board

Notes:

- (1) Available in tape and reel only. A reel contains 5,000 devices.
- (2) Lead-free package only. Device is WEEE and RoHS compliant, and halogen free.
- (3) Device is AEC-Q100 (Grade3) qualified.

### Marking Information(SC33020H)

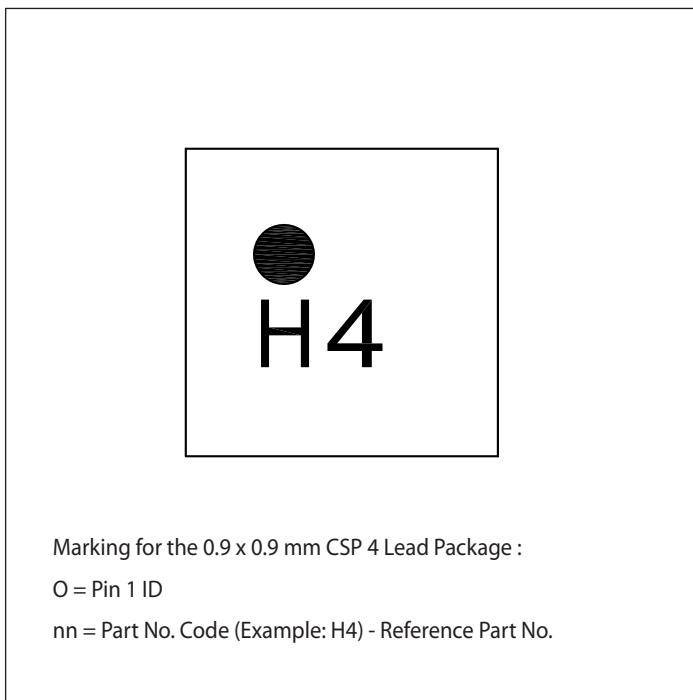

### Marking Information(SC33020HQ)

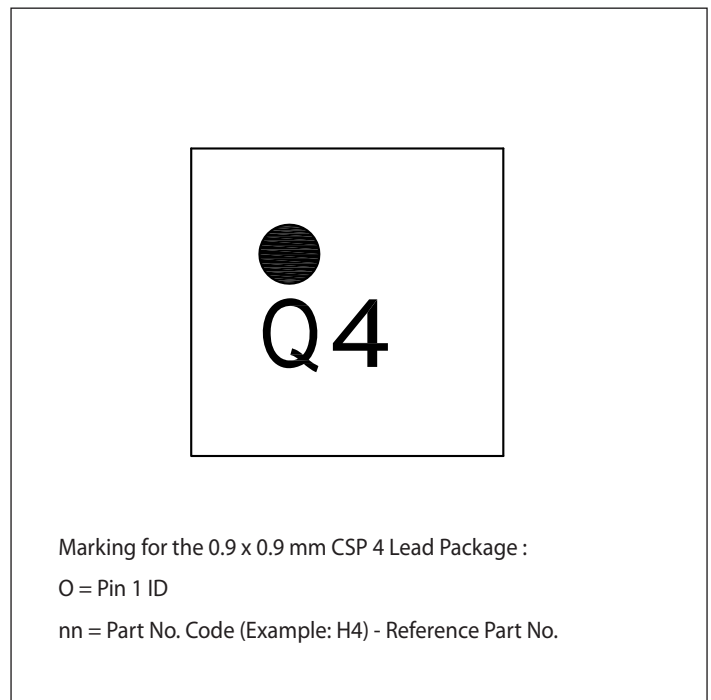

## Absolute Maximum Ratings

V <sub>IN</sub> to GND (V).....	-0.3 to +6.0
EN to GND (V).....	-0.3 to +6.0
V <sub>OUT</sub> to GND (V).....	-0.3 to (V <sub>VIN</sub> +0.3)
ESD Protection Level HBM <sup>(1)</sup> (kV).....	4

## Recommended Operating Conditions

Maximum Output Current (A) .....	2
V <sub>VIN</sub> (V).....	1.6 to 5.5
Operating Ambient Temperature (°C).....	-40 to 85

## Thermal Information

Thermal Resistance, Junction to Ambient<sup>(2)</sup>

CSP (°C/W) .....	140
Maximum Junction Temperature (°C) .....	+125
Storage Temperature Range (°C).....	-65 to +150
Peak IR Reflow Temperature (10s to 30s) (°C) .....	+260

Exceeding the above specifications may result in permanent damage to the device or device malfunction. Operation outside of the parameters specified in the Electrical Characteristics section is not recommended.

### NOTES:

- (1) Tested according to JEDEC standard JS-001-2012.
- (2) Calculated from package in still air, mounted to 3 x 4.5 (in), 4 layer FR4 PCB with thermal via under the exposed pad per JESD51 standards.

## Electrical Characteristics

Unless noted otherwise, T<sub>A</sub> = 25°C for typical, -40°C ≤ T<sub>A</sub> = T<sub>J</sub> ≤ +85°C for min and max, V<sub>IN</sub> = 2.8V, C<sub>IN</sub> = 1μF, C<sub>OUT</sub> = 1μF, V<sub>EN</sub> = V<sub>VIN</sub>.

Parameter	Symbol	Conditions	Min	Typ	Max	Units
Ron	R <sub>ON</sub>	V <sub>IN</sub> =5.5V, I <sub>OUT</sub> =200mA, V <sub>EN</sub> =1.5V		25		mΩ
		V <sub>IN</sub> =4.3V, I <sub>OUT</sub> =200mA, V <sub>EN</sub> =1.5V		28		mΩ
		V <sub>IN</sub> =3.3V, I <sub>OUT</sub> =200mA, V <sub>EN</sub> =1.5V		32	43	mΩ
		V <sub>IN</sub> =2.5V, I <sub>OUT</sub> =200mA, V <sub>EN</sub> =1.5V		40		mΩ
		V <sub>IN</sub> =1.6V, I <sub>OUT</sub> =200mA, V <sub>EN</sub> =1.5V		65		mΩ
Quiescent Current <sup>(1)</sup>	I <sub>Q</sub>	V <sub>IN</sub> =V <sub>EN</sub> =3.6V, V <sub>OUT</sub> =open		1	3	μA
Shutdown Current	I <sub>SD</sub>	V <sub>EN</sub> =0, V <sub>OUT</sub> =open		0.3	2	μA
		V <sub>EN</sub> =0, V <sub>OUT</sub> =open, T <sub>A</sub> =25°C			1.3	μA
Turn-on Delay Time <sup>(2)</sup>	T <sub>DT</sub>	V <sub>EN</sub> =1.5V, V <sub>IN</sub> =3.6V, I <sub>OUT</sub> =200mA, C <sub>OUT</sub> =1μF		440		μs
Rising Time <sup>(2)</sup>	T <sub>RT</sub>	V <sub>EN</sub> =1.5V, V <sub>IN</sub> =3.6V, I <sub>OUT</sub> =200mA, C <sub>OUT</sub> =1μF		640		μs
<b>Reverse Blocking</b>						
Reverse Blocking Current (I <sub>OUT</sub> )	R <sub>I</sub>	V <sub>EN</sub> =0V, V <sub>IN</sub> =0V, V <sub>OUT</sub> =5.5V		3	13	μA
Reverse Blocking Threshold	R <sub>BT</sub>	V <sub>OUT</sub> =2.8V, V <sub>OUT</sub> -V <sub>IN</sub>		75		mV
Reverse Blocking Hysteresis	R <sub>BH</sub>	V <sub>OUT</sub> =2.8V, V <sub>OUT</sub> -V <sub>IN</sub>		25		mV

**Electrical Characteristics (continued)**

Parameter	Symbol	Conditions	Min	Typ	Max	Units
<b>EN Digital Input</b>						
EN Input High Threshold	$V_{EN-HH}$				1.0	V
EN Input Low Threshold	$V_{EN-LL}$		0.4			V
EN Input Pull-Down Resistance	$R_{EN}$			7		M $\Omega$

## NOTES:

- (1)  $I_O$  current includes EN pull-down current.
- (2) For other  $T_{DT}$  and  $T_{RT}$  options, please contact SEMTECH.

## Pin Descriptions

Pin#	Pin Name	Pin Function
A1	VIN	Input supply voltage.
B1	EN	Enable input. A 7MΩ internal resistor is connected from this pin to GND. Drive HIGH to turn on the switch; drive LOW to turn off the switch. When the EN pin is floated, the switch is OFF.
A2	OUT	Output voltage.
B2	GND	Ground.

## Timing Diagram

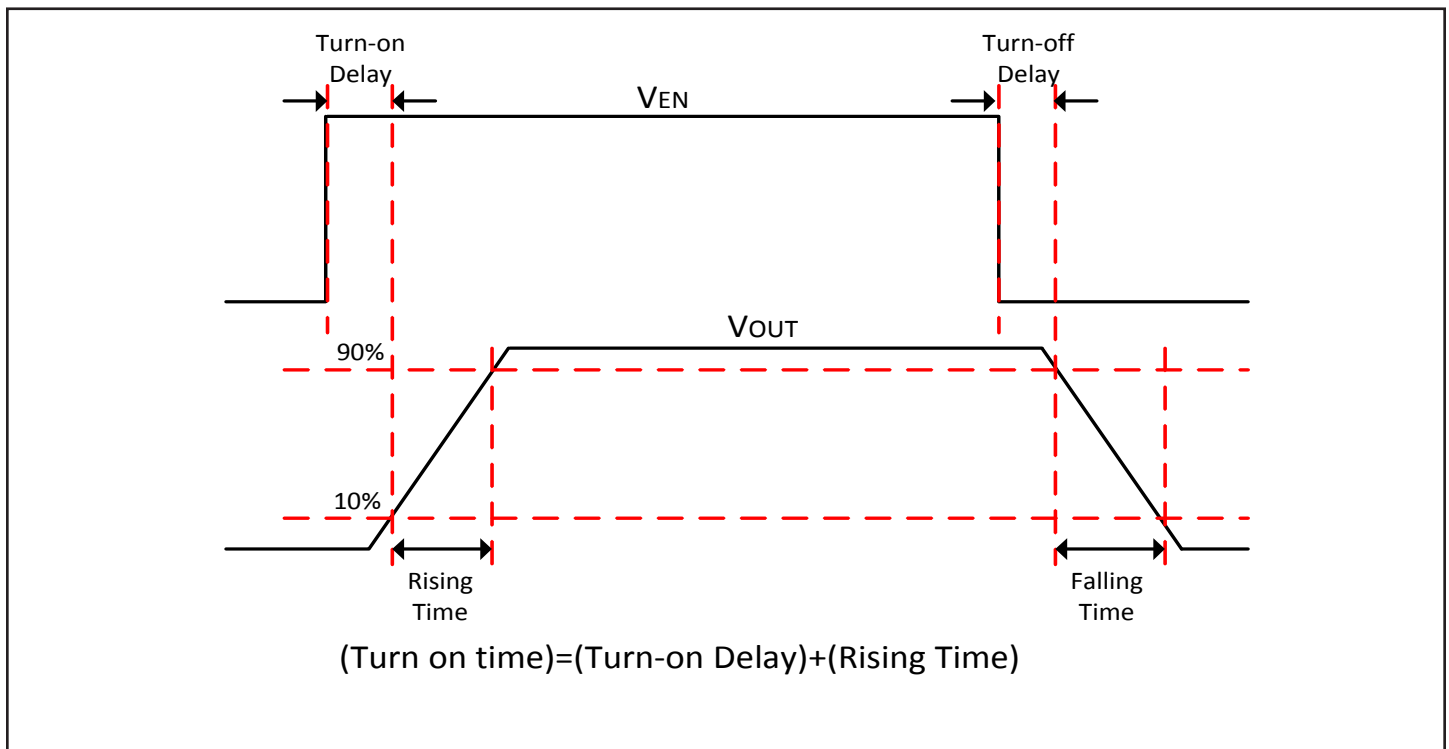

## Typical Characteristics

Start Up by VIN

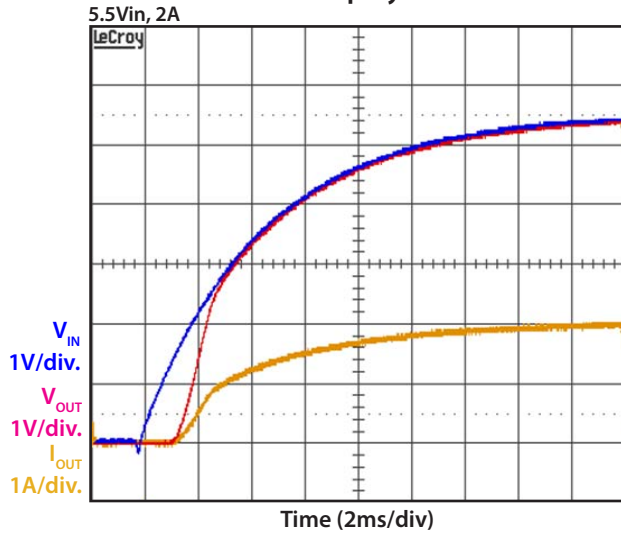

Shut Down by VIN

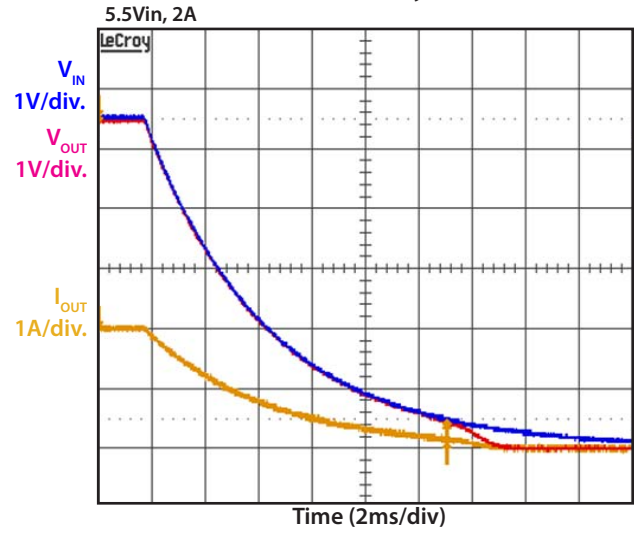

Start Up by EN

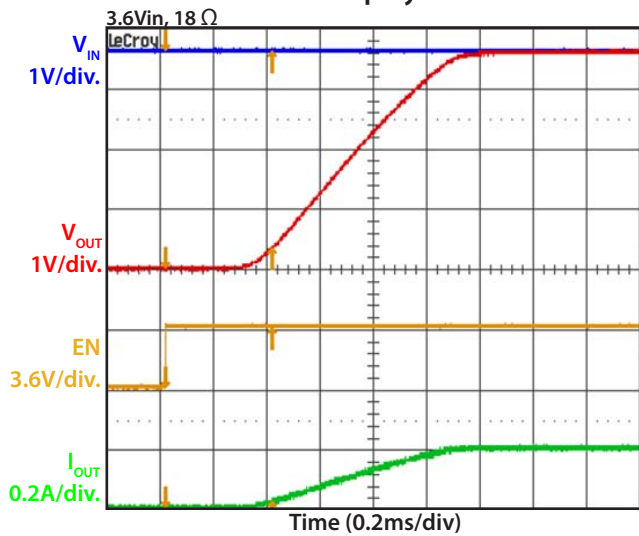

Start Up by EN

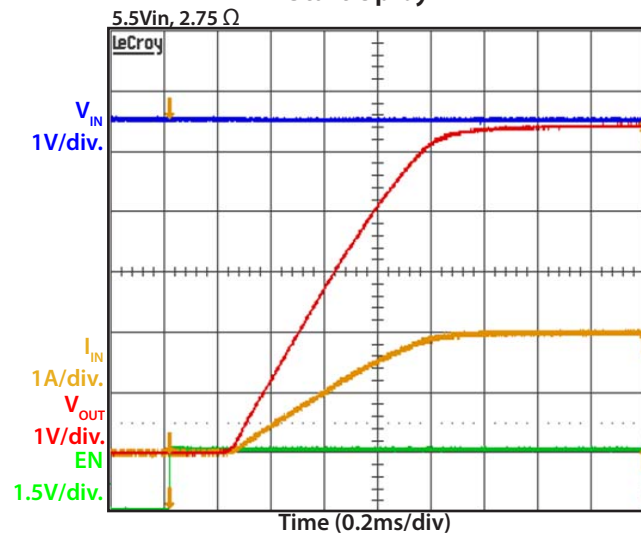

Shut Down by EN

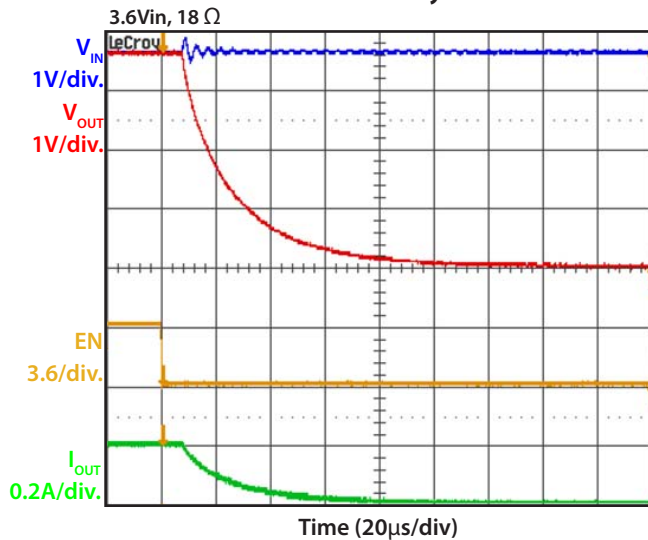

Reverse Blocking

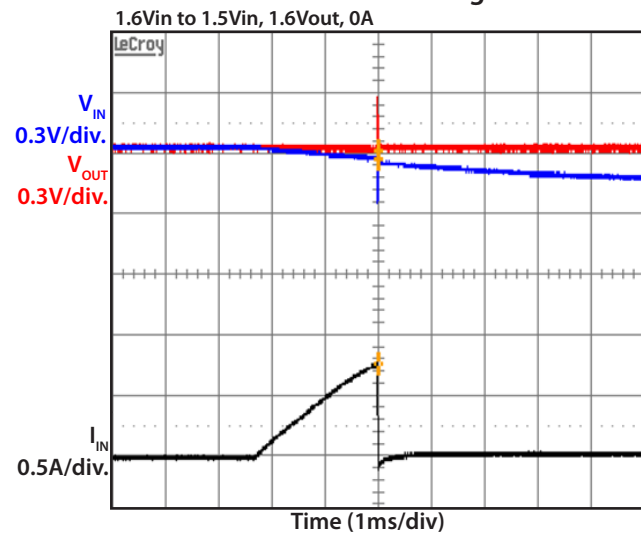

Typical Characteristics, Cont.

On Resistance vs. Temperature

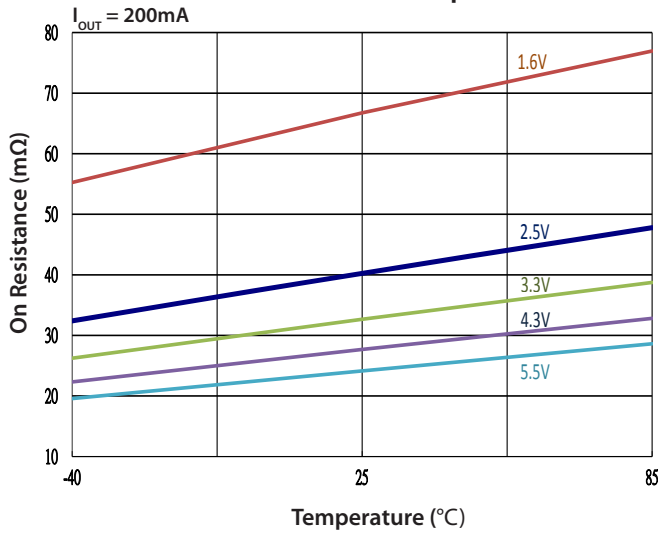

On Resistance vs. Temperature

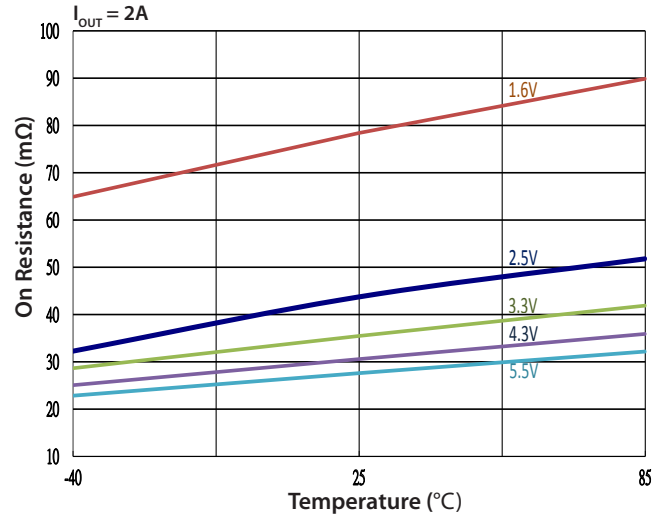

On Resistance vs. Input Voltage

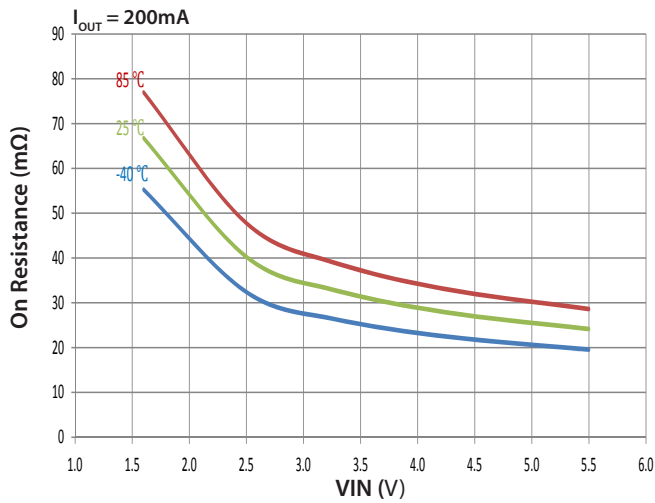

Shut Down Current vs. Temperature

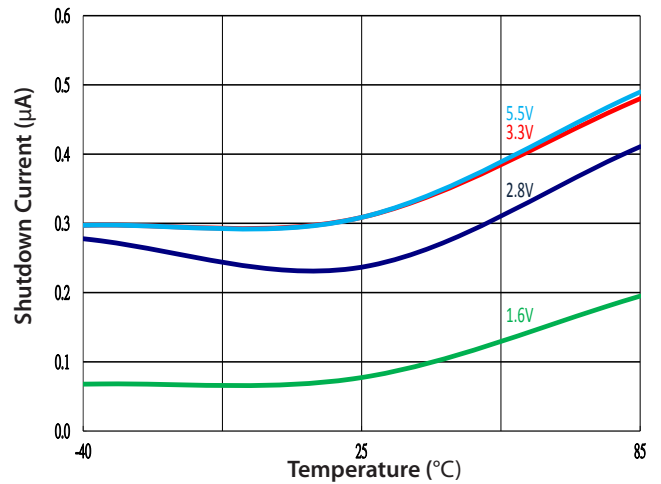

Quiescent Current vs. Temperature

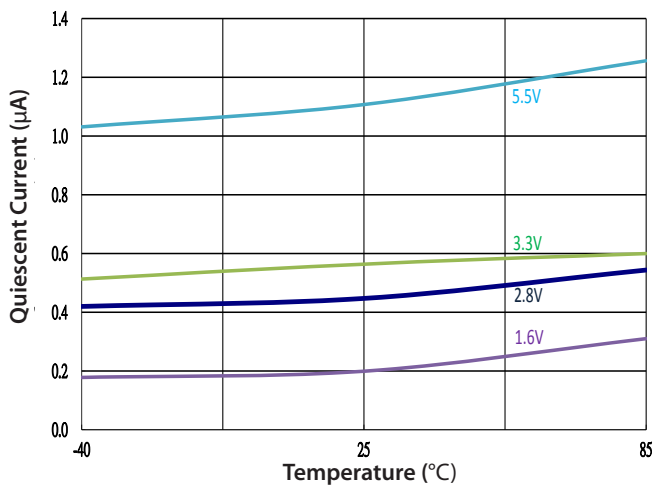

EN Pull-Down Resistance vs. Temperature

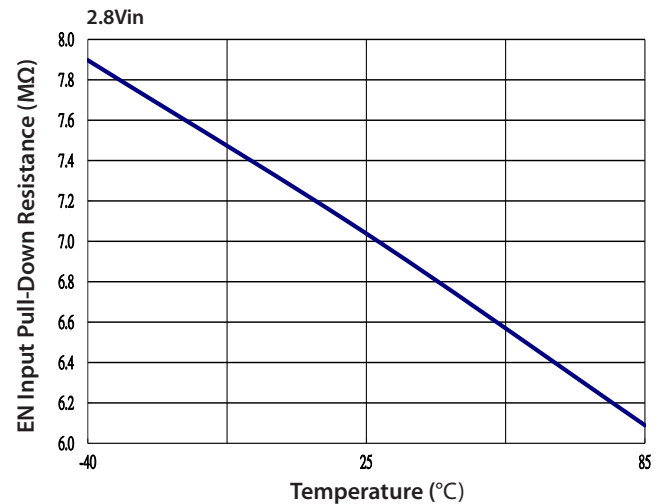

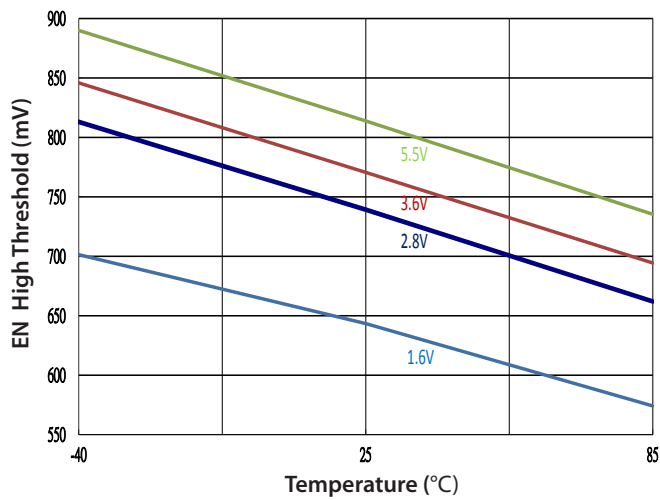
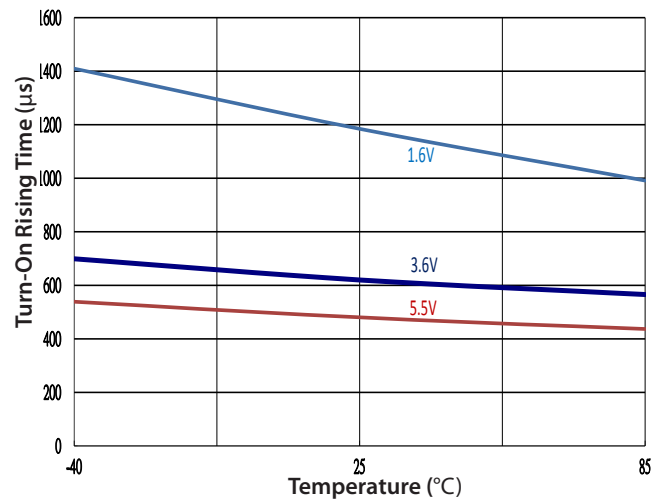
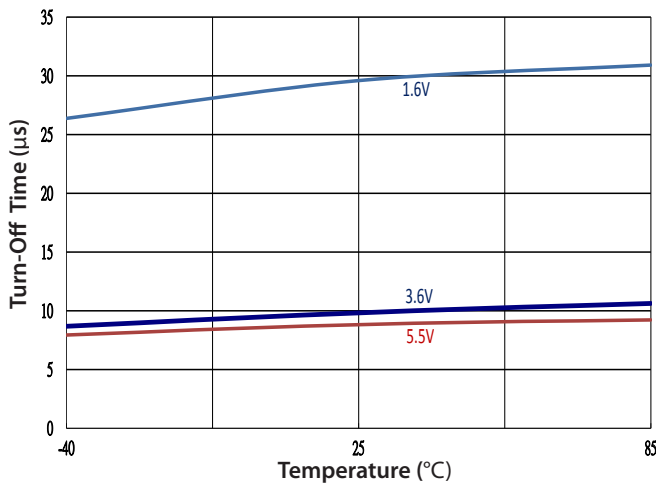
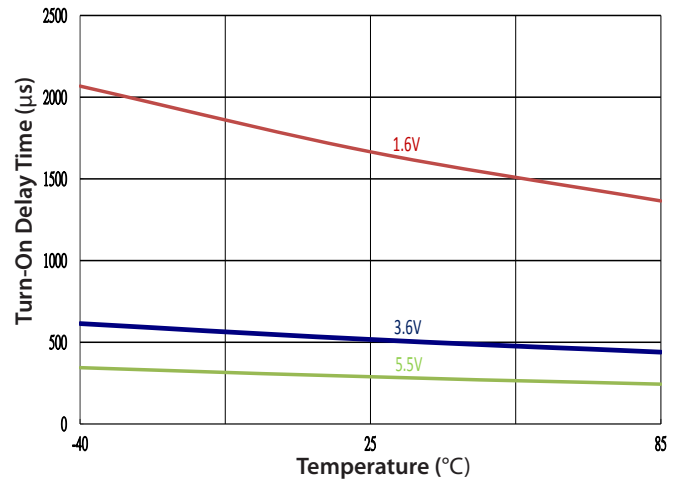
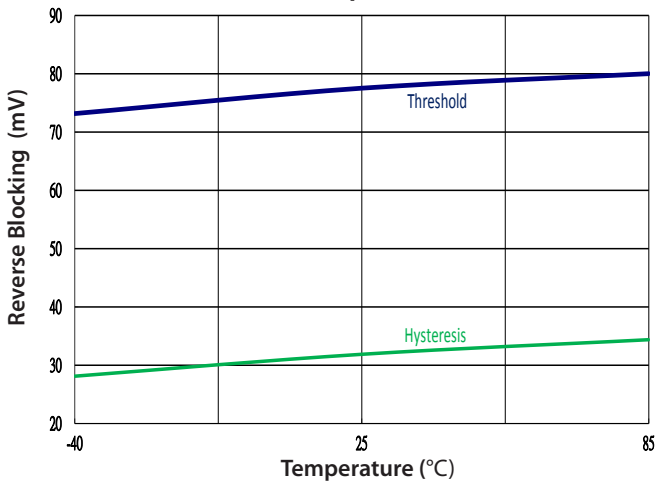
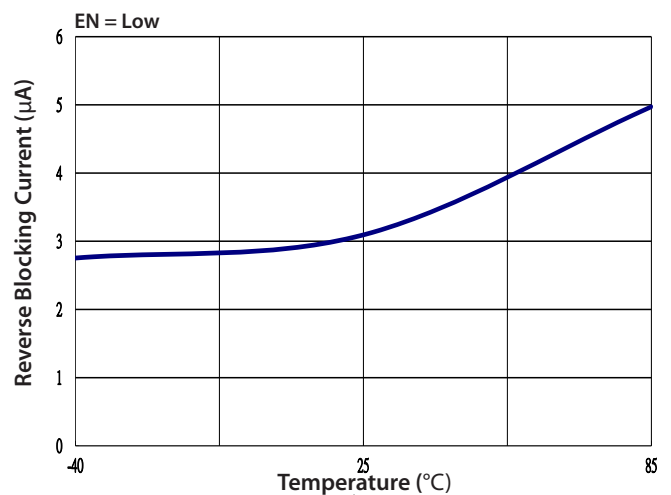
**Typical Characteristics, Cont.**
**EN HIGH Threshold vs. Temperature**

**Rising Time vs. Temperature**

**Turn-off Time vs. Temperature**

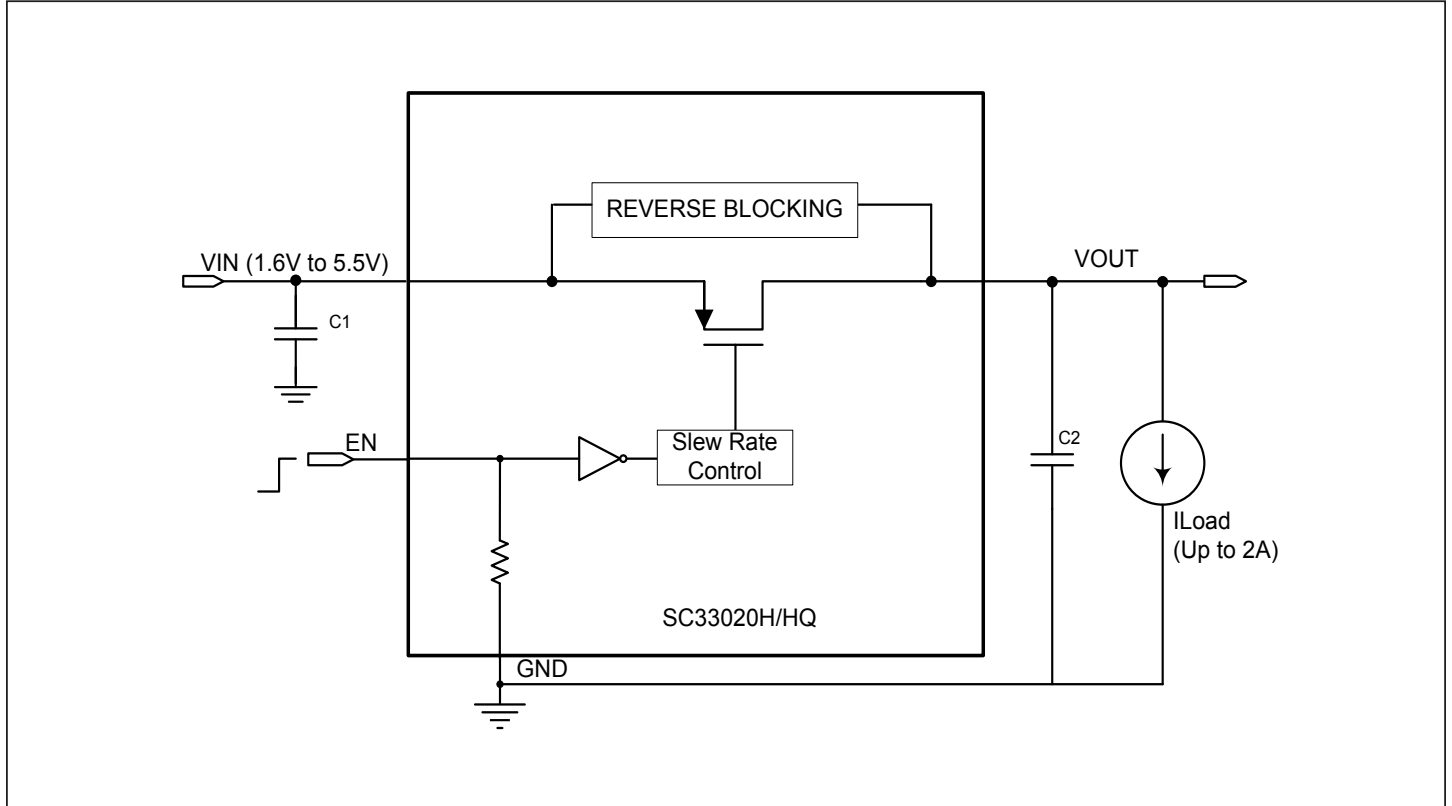
**Turn-on Delay Time vs. Temperature**

**Reverse Blocking Threshold and Hysteresis vs. Temperature**

**Reverse Blocking Current vs. Temperature**



**Block Diagram**



## Application Information

### Operation

The SC33020H/HQ is an integrated high-side PMOS load switch that is designed to support up to 2A continuous output current and operates from an input voltage from 1.6V to 5.5V. The internal PMOS pass element has a very low ON resistance of 32mΩ (typical) at  $V_{IN} = 3.3V$ . The SC33020H/HQ also provides ultra-low shutdown and quiescent current for extended battery life during shutdown and standby conditions.

An internal soft start circuit is used to control the start-up time of the load switch to reduce inrush current during start up.

### Enable

The EN pin controls the ON/OFF state of the load switch. Pulling the EN pin HIGH turns on the load switch. Pulling the EN pin LOW turns off the load switch. The EN pin incorporates a 7MΩ (typical) pull-down resistor, so that when the EN pin is floating the SC33020H/HQ is disabled.

### Reverse Blocking

The SC33020H/HQ integrates a reverse current blocking circuit to prevent current flow from VOUT to VIN during both ON and OFF states. The reverse current blocking circuit is active when voltage is present on either the VIN or the VOUT. A comparator is used to sense and compare the VOUT voltage to the VIN voltage. Whenever the VOUT voltage is 75mV (typical at 25°C) higher than VIN, the Reverse Blocking circuit is triggered and reverse current is blocked from VOUT to VIN. Please note that when  $0 < V_{OUT} - V_{IN} < 75mV$  (typical at 25°C), some small reverse current is possible. An example is shown in Fig. 1. Usually, worst case for reverse current occurs at elevated input voltages and reduced temperatures.

The following formula can be used to calculate the reverse peak current before the Reverse Blocking circuit is triggered.

$$I_{RC} = \frac{V_{RBT}}{R_{ON}}$$

- $I_{RC}$  - Reverse peak current.
- $R_{ON}$  - On-Resistance, (Usually, is smaller resistance at higher  $V_{IN}$  and lower temperature.)
- $V_{RBT}$  - Reverse voltage threshold.

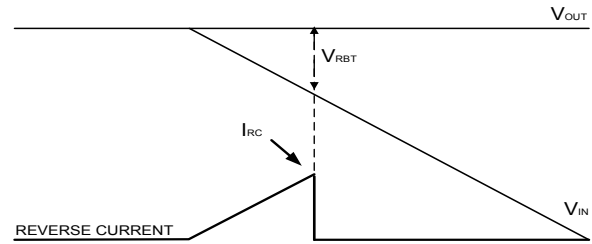

Figure 1

### Input Capacitor

In order to reduce the effect of voltage drop, noise and bounce at the VIN pin, a filter/decoupling capacitor between VIN to GND is recommended. A 1μF ceramic capacitor is sufficient for most application conditions. However, it should be noted that suppressing bounce at input loop after EN is changed from HIGH to LOW can require greater capacitor values depending on particular designs.

In circuit design, ceramic capacitors should be derated for operating temperature and voltage. For applications up to 3.6V, capacitors should be rated at 6.3V or higher. For applications up to 5.5V, capacitors should be rated at 10V or higher.

### Output Capacitor

A 1μF ceramic capacitor is normally used at the VOUT pin to filter noise. If a larger output capacitance value is used, the input inrush current should be considered because the power-on transient is also dependent on the output capacitor value. Please use the same derating criteria for the output capacitor selection.

### Board Layout Considerations

Fig. 2 shows a typical application circuit with PCB inductance on the circuit board. An important objective of the layout is to minimize the PCB inductance by reducing the length and increasing the width of the traces. PCB inductance can affect circuit performance during turn-off, load transients, and Reverse Blocking. Fig. 2 shows three current loops during the opening or closing of the load switch. The magnitude of the voltage ringing at VIN or VOUT pin

## Application Information, Cont.

is related to the PCB stray inductance and the placement of the capacitors. The input capacitor C1 and output capacitor C2 need to be placed close to the SC33020H/HQ. It is important to keep the voltage ringing below the maximum voltage rating of the SC33020H/HQ.

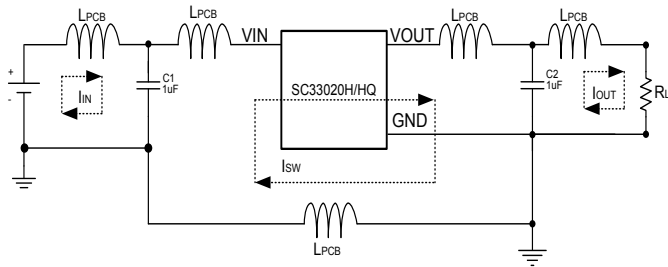

**Figure 2 - PCB Circuit with Equivalent Parasitic Inductance**

## Evaluation Board Information

The Top Layer and Bottom Layer of a standard evaluation board are shown in Fig. 3 and Fig. 4, respectively.

Both T1 and T2 test points are Kelvin connections which can be used to minimize the measurement error of  $R_{ON}$ . To enable the part, a jumper can be used between VIN and EN on J1. To disable the part, a jumper can be connected between EN and GND on J1. C3 is an optional solution to improve ringing at input rail during turn-off and reverse blocking conditions.

**Top Layer, SC33020H**

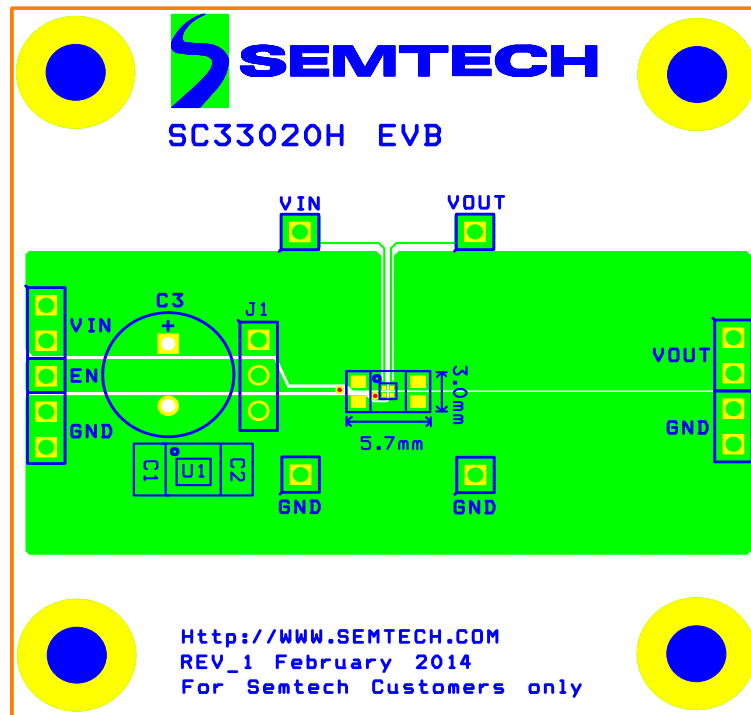

Figure 3

**Bottom Layer, SC33020H**

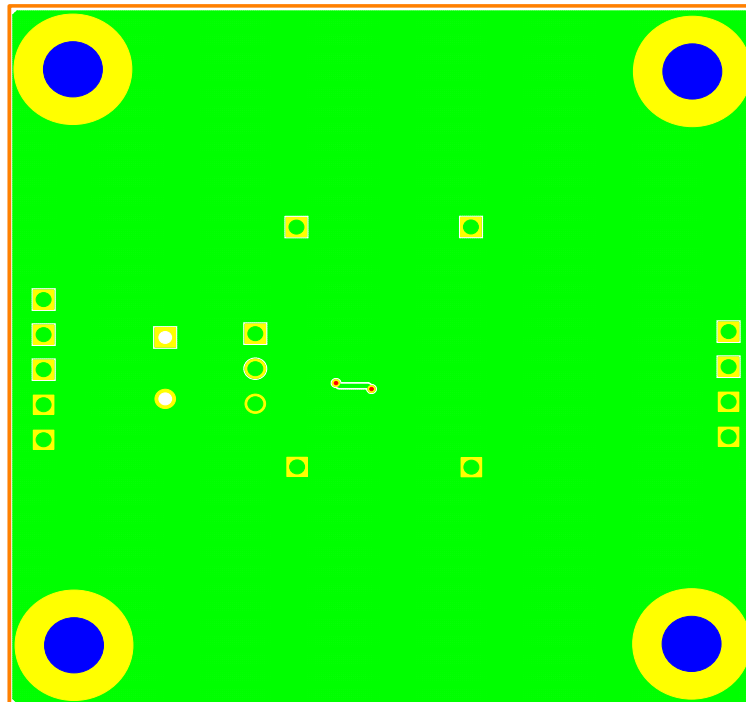

Figure 4

**Top Layer, SC33020HQ**

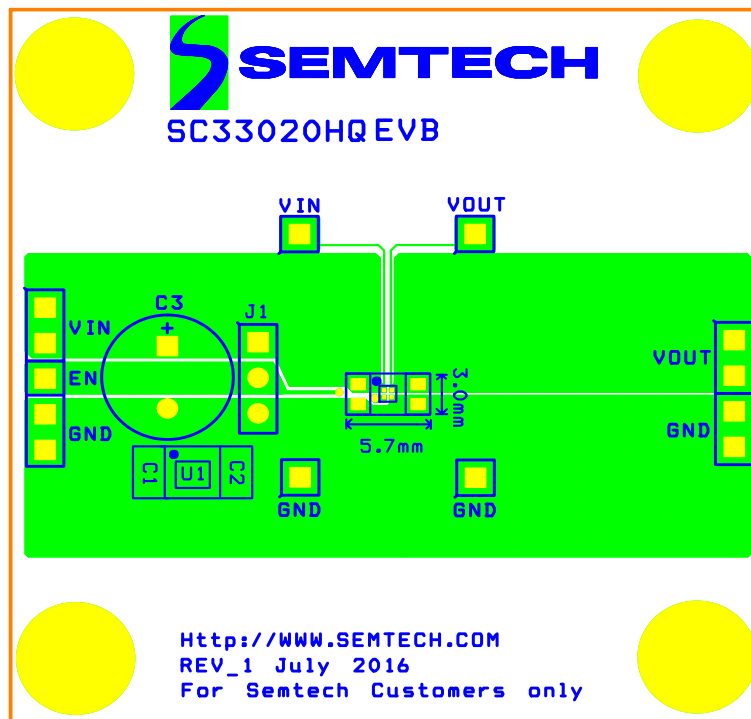

Figure 5

**Bottom Layer, SC33020HQ**

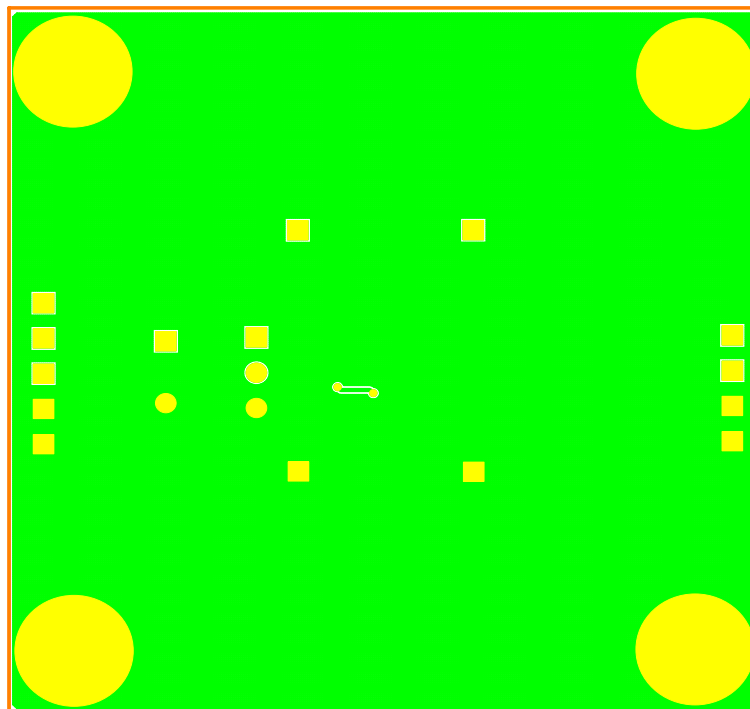
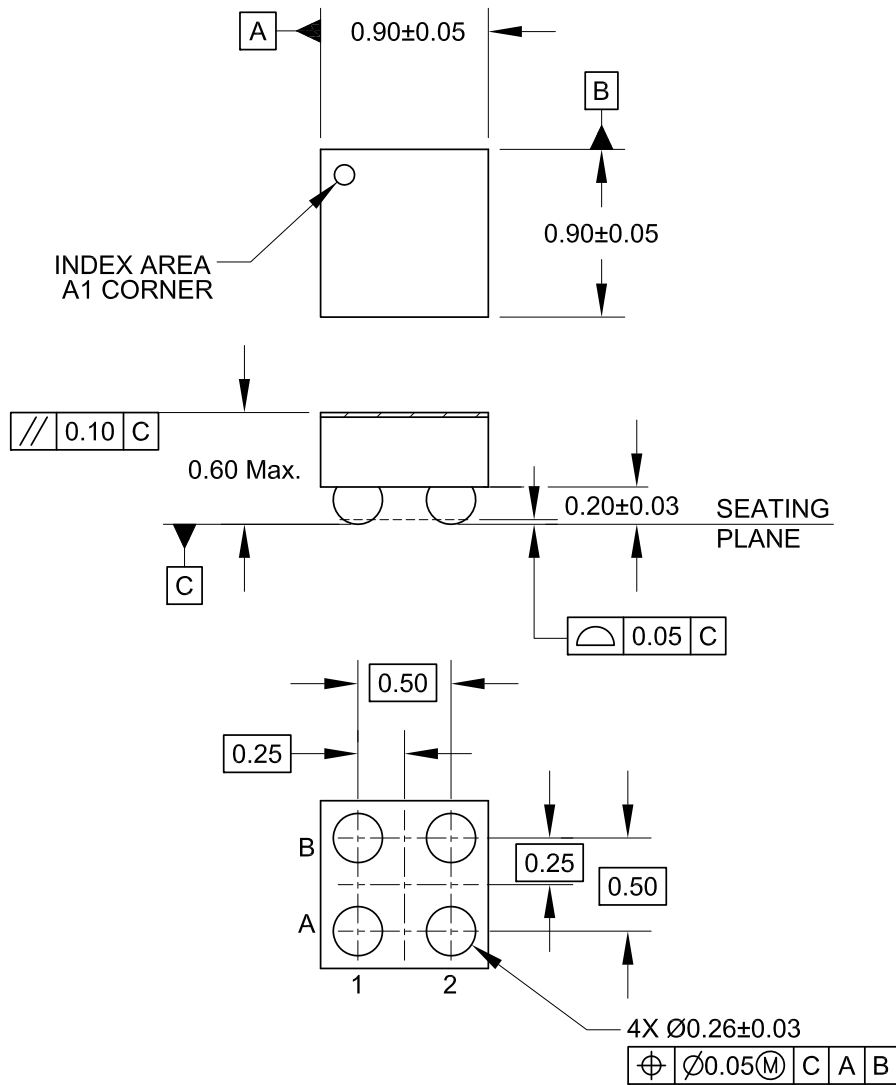
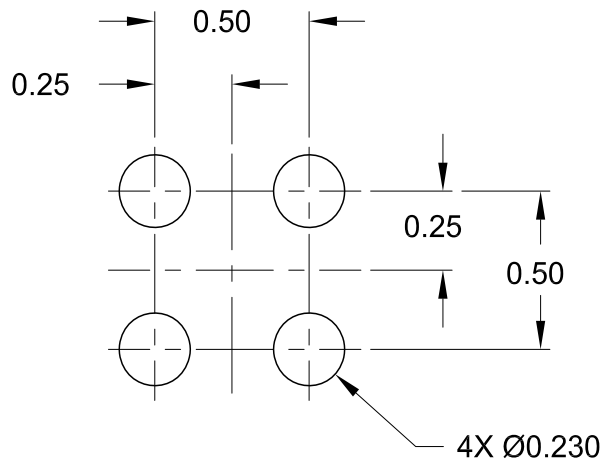

Figure 6

**Outline Drawing — CSP 0.9mm X 0.9mm, 4 Lead**

**NOTES:**

1. CONTROLLING DIMENSIONS ARE IN MILLIMETERS

**Land Pattern — CSP 0.9mm X 0.9mm, 4 Lead**

**NOTES:**

1. CONTROLLING DIMENSIONS ARE IN MILLIMETERS
2. THIS LAND PATTERN IS FOR REFERENCE PURPOSES ONLY. CONSULT YOUR MANUFACTURING GROUP TO ENSURE YOUR COMPANY'S MANUFACTURING GUIDELINES ARE MET.

© Semtech 2017

All rights reserved. Reproduction in whole or in part is prohibited without the prior written consent of the copyright owner. The information presented in this document does not form part of any quotation or contract, is believed to be accurate and reliable and may be changed without notice. No liability will be accepted by the publisher for any consequence of its use. Publication thereof does not convey nor imply any license under patent or other industrial or intellectual property rights. Semtech assumes no responsibility or liability whatsoever for any failure or unexpected operation resulting from misuse, neglect improper installation, repair or improper handling or unusual physical or electrical stress including, but not limited to, exposure to parameters beyond the specified maximum ratings or operation outside the specified range.

SEMTECH PRODUCTS ARE NOT DESIGNED, INTENDED, AUTHORIZED OR WARRANTED TO BE SUITABLE FOR USE IN LIFE-SUPPORT APPLICATIONS, DEVICES OR SYSTEMS OR OTHER CRITICAL APPLICATIONS. INCLUSION OF SEMTECH PRODUCTS IN SUCH APPLICATIONS IS UNDERSTOOD TO BE UNDERTAKEN SOLELY AT THE CUSTOMER'S OWN RISK. Should a customer purchase or use Semtech products for any such unauthorized application, the customer shall indemnify and hold Semtech and its officers, employees, subsidiaries, affiliates, and distributors harmless against all claims, costs damages and attorney fees which could arise.

Notice: All referenced brands, product names, service names and trademarks are the property of their respective owners.

## Contact Information

---

Semtech Corporation  
Power Management Products Division  
200 Flynn Road, Camarillo, CA 93012  
Phone: (805) 498-2111 Fax: (805) 498-3804

[www.semtech.com](http://www.semtech.com)