A large, light blue decorative graphic consisting of a thick, curved line that forms a partial circle, with a small white circle at its top end, resembling a stylized 'C' or a partial orbit.

Phase Cut Dimmable Isolated Flyback Converter for PAR38 LED Lamp with **ICL8002G & CoolMOS™ 600V C6**

Application Note

<http://www.infineon.com/ledoffline>

Rev. 1.0, 2012 -06 -21

Edition June, 2012
Published by
Infineon Technologies AG
81726 Munich, Germany
© 2012 Infineon Technologies AG
All Rights Reserved.
Legal Disclaimer

The information given in this document shall in no event be regarded as a guarantee of conditions or characteristics. With respect to any examples or hints given herein, any typical values stated herein and/or any information regarding the application of the device, Infineon Technologies hereby disclaims any and all warranties and liabilities of any kind, including without limitation, warranties of non-infringement of intellectual property rights of any third party.

Information

For further information on technology, delivery terms and conditions and prices, please contact the nearest Infineon Technologies Office (www.infineon.com).

Warnings

Due to technical requirements, components may contain dangerous substances. For information on the types in question, please contact the nearest Infineon Technologies Office.

Infineon Technologies components may be used in life-support devices or systems only with the express written approval of Infineon Technologies, if a failure of such components can reasonably be expected to cause the failure of that life-support device or system or to affect the safety or effectiveness of that device or system. Life support devices or systems are intended to be implanted in the human body or to support and/or maintain and sustain and/or protect human life. If they fail, it is reasonable to assume that the health of the user or other persons may be endangered.

Table of Contents

1	Introduction	4
2	List of Features	4
3	Technical Specification	4
4	Setup	5
	4.1 Input Connection	5
	4.2 Output Connection	5
5	Schematic	6
6	Test Data and Waveforms	7
	6.1 Efficiency	7
	6.2 Start-Up	8
	6.3 Power Factor & THD	9
	6.4 Power MOSFET Waveforms	10
	6.5 Output	11
	6.6 Output Current Regulation	11
	6.7 LED Open Load Protection	13
	6.8 Output Short Circuit Protection	14
7	Dimming	15
8	Board Layout	16
9	Bill of Materials	17
10	Transformer	20
11	Related Documentation	21

1 Introduction

The PAR38 EVAL-LED-ICL8002G is a dimmable single-stage PFC/ Fly-back LED driver designed for high efficiency, high power factor, low THD and isolation. **The ICL G's** quasi-resonant operation mode, primary side control, cycle-by-cycle current control, integrated PFC and phase-cut dimming control makes it an excellent choice for dimmable LED bulbs especially those requiring very high efficiency.

2 List of Features

- High efficiency > 89%
- High Power Factor (>0.97) with low THD (<10%).
- High Dimmer compatibility.
- Quasi-resonant operation mode with isolated Fly-back.
- Primary side control with integrated PFC.
- Integrated Start-Up Power cell.
- Built-in digital soft-start
- Cycle-by-cycle peak current limitation
- VCC over- and under-voltage lockout
- Auto restart mode for short circuit and thermal protection
- Adjustable latch-off mode for output overvoltage protection

3 Technical Specification

Parameter	Value	Unit
Input Voltage	108-132	Vrms
Line Frequency	60	
Output Voltage	32-40	Vdc
Output LED Current	560	mA
Output Power	22	W
Power Factor	> 0.97	
THD	< 10	%
Efficiency	> 89	%

Table 1 Specification

4 Setup

Attention:



This Evaluation board is not protected against human touch. Do not touch live board due to dangerous voltages. Do not leave board unattended when it is powered up.

4.1 Input Connection

AC source is applied at the two terminals near the common mode inductor. Please refer to **Figure 1** for input voltage connection and **Table 1** for input voltage range. For dimming operation, the phase cut dimmer should be connected to the input terminals according to the dimmer's instructions provided by the dimmer manufacturer.

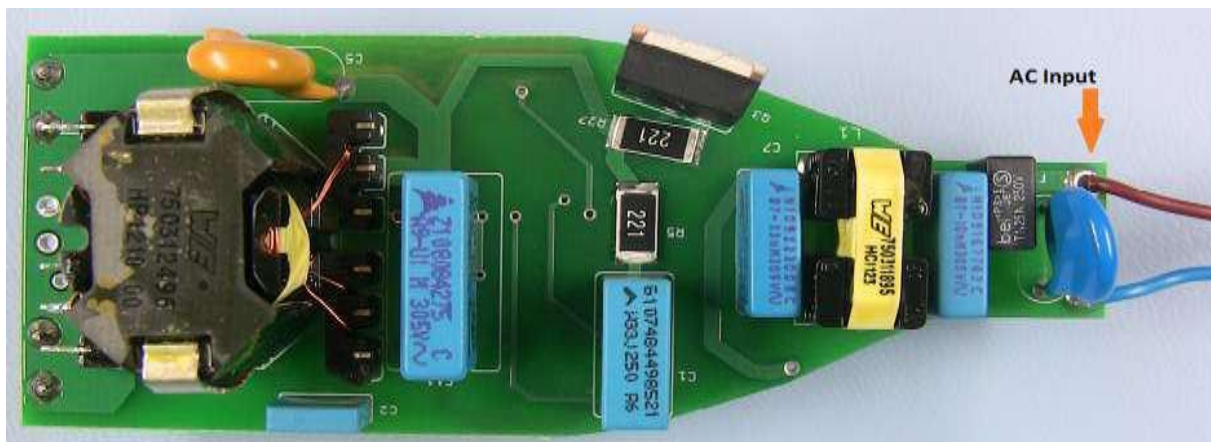

Figure 1 Top Side of PAR38 EVAL-LED-ICL8002G

4.2 Output Connection

The output is functionally isolated from the AC input supply. Connect the load at the electrolytic capacitors C3 and C4. Please refer to **Figure 2**. Please make sure not to exceed the maximum output voltage. For the output voltage range (number of LEDs in string) please refer to **Table 1**.

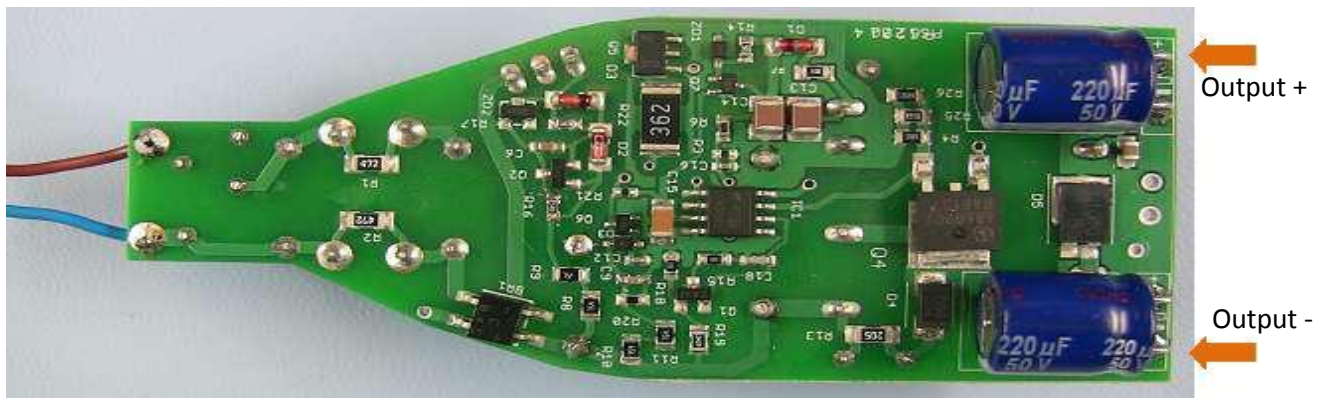

Figure 2 Bottom Side of PAR38 EVAL-LED-ICL8002G

5 Schematic

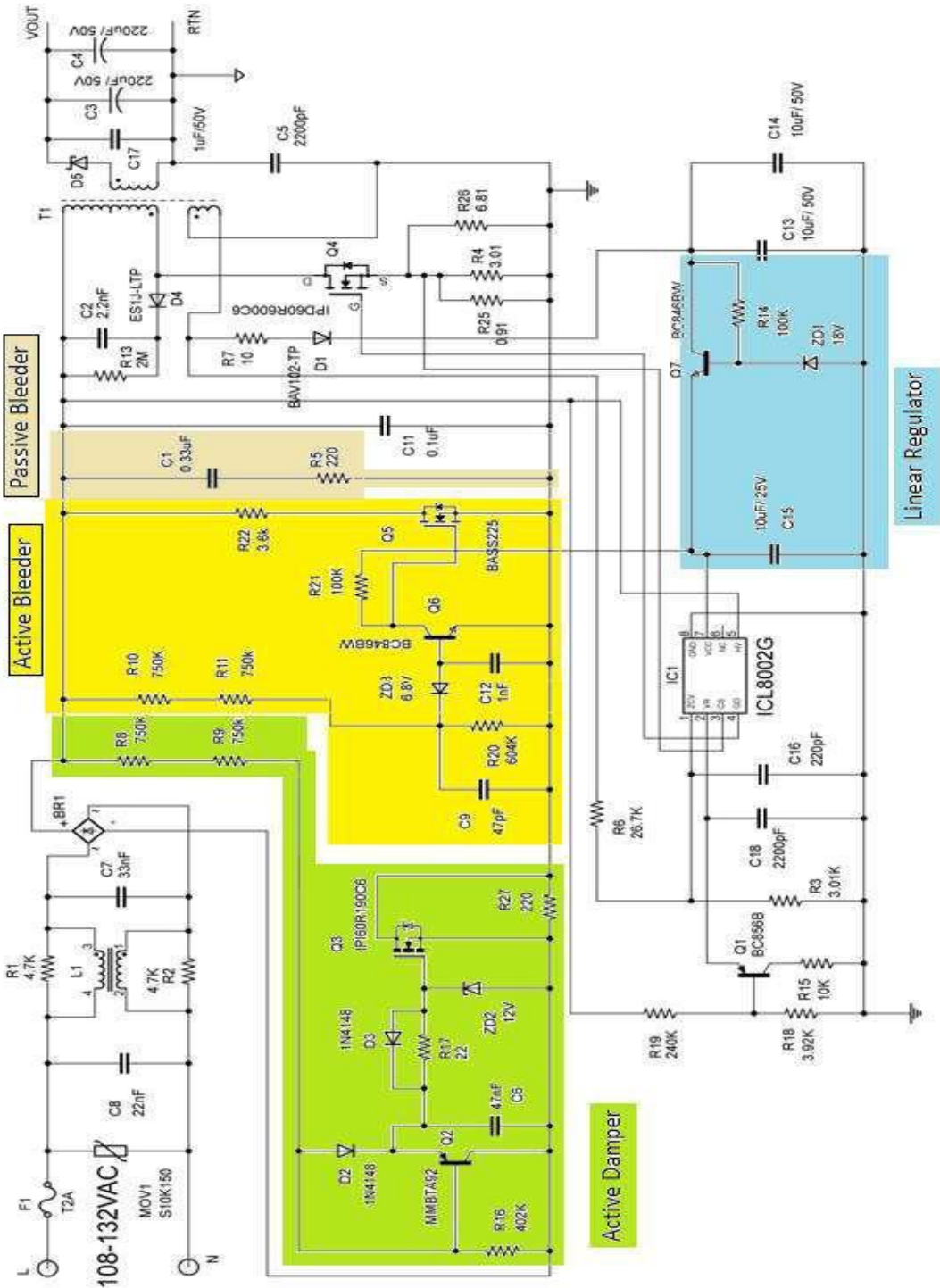

Figure 3 Schematic

PAR38 EVAL-LED-ICL8002G

The ICL8002G is a quasi-resonant PWM controller that can operate in different topologies such as Buck and Fly-back converters. The PAR38 EVAL-LED-ICL8002G is designed using the Fly-back topology to provide isolation. Test Data and typical operating waveforms are shown below. See app note AN-EVALLED-ICL8002G-B2 for details on the non isolated buck topology.

6 Test data and Waveforms

6.1 Efficiency

The Quasi-Resonant operation of this controller **o i e d i t h I f i e o ' s h i g h p e r f o r a n e** Coolmos™ HV MOSFETs; results in high conversion efficiency. The chart below is taken at nominal input voltage of 120VRMS. Efficiency is dependent on output voltage. The ICL8002G IC is designed to maintain constant output power. If the number of LEDs in the string is reduced (output voltage is reduced), the LED current increases resulting in increased power loss in the output diode. This results in slight loss of efficiency which as shown in figure 4.

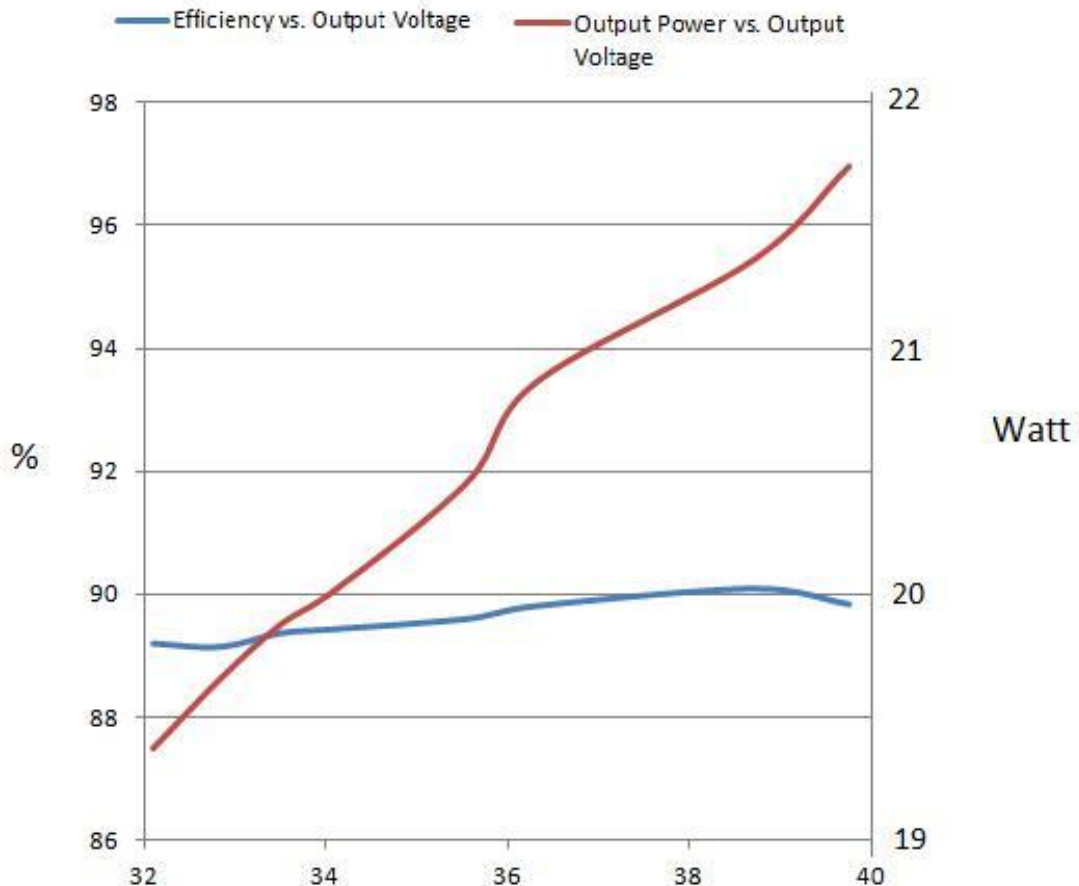

Figure 4 Efficiency vs Output Voltage

PAR38 EVAL-LED-ICL8002G

This output diode is a significant contributor to power loss overall. If additional efficiency is required, active rectification can be applied to increase efficiency by 1-2%.

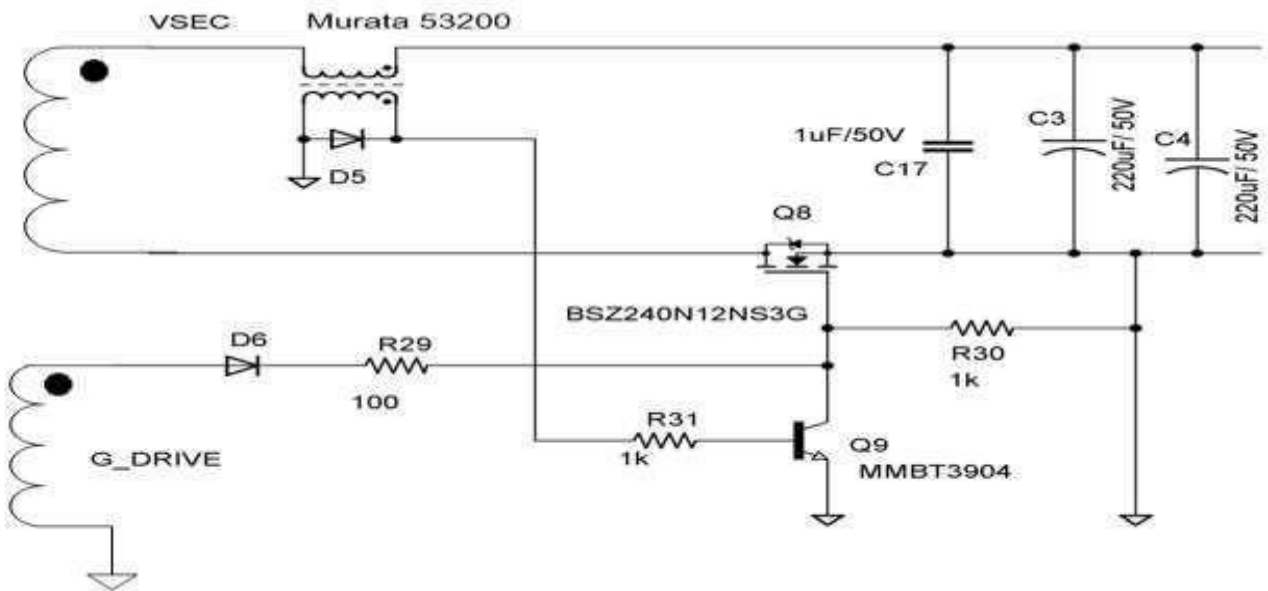

Figure 5 Secondary with Synchronous Rectification

On the other hand, if cost is valued over efficiency, components with lower cost can be substituted for Q3, Q4 and D5. Q4 can be replaced with IPD60R950C6 which results in a 0.1% drop in efficiency. Q3 can be substituted with a lower V_{DS} and/ or higher R_{ds-on} MOSFET such as Infineon's new CE 500V V_{ds} series. Replacing Q3 with IPP60R950C6 (higher R_{ds-on}) drops efficiency by 0.25%. Additional cost reduction can be achieved by eliminating the active damper (highlighted in green in schematic above) and substituting a 33- Ω three watt resistor in series with fuse F1. The substitution of the resistor lowers efficiency by about 3%. Other cost reductions can also be considered including changing output diode D5 or the transformer to a lower cost selection. These may also affect efficiency.

6.2 Start Up

The ICL8002G integrates a start-up cell to charge V_{cc} capacitor (C15) in order to kick-start the controller into operation. Please refer to schematic. The integrated start-up cell allows for short start-up times of the system without sacrificing efficiency. The below waveforms were obtained with $C15=10\mu F$. If a shorter Start-up time is required, the value of C15 can be reduced.

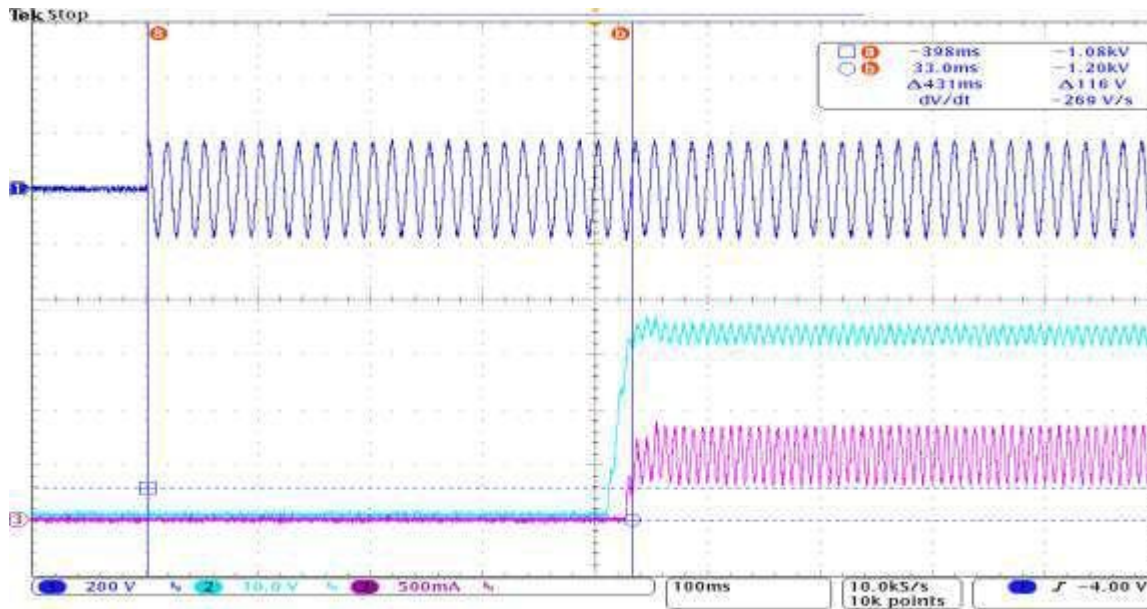

Figure 6 Start-up waveform: Input voltage (CH1, Blue), Output voltage (CH2, Turquoise), and output current (CH3, Pink)

6.3 Power Factor & THD

The input current and voltage waveforms are shown in Figure 7 below. The input current waveform shown below is sinusoidal and in phase with the input voltage indicating low THD (Total Harmonic Distortion) and high PF (Power Factor). Measured PF and THD over the entire input voltage range are given below.

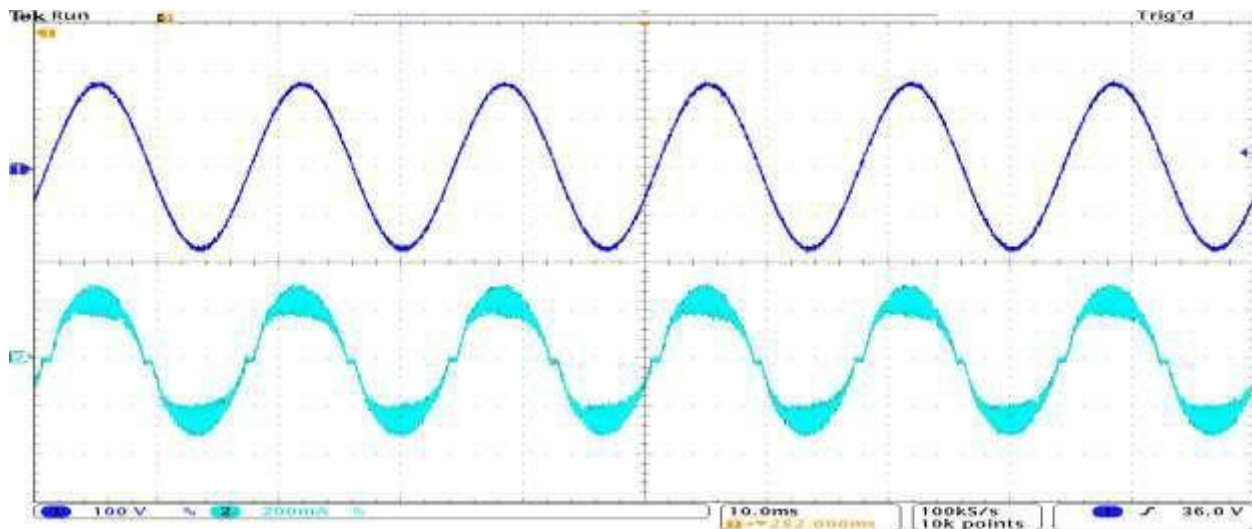

Figure 7 Input voltage (CH1, Blue), Input current (CH2, Turquoise).

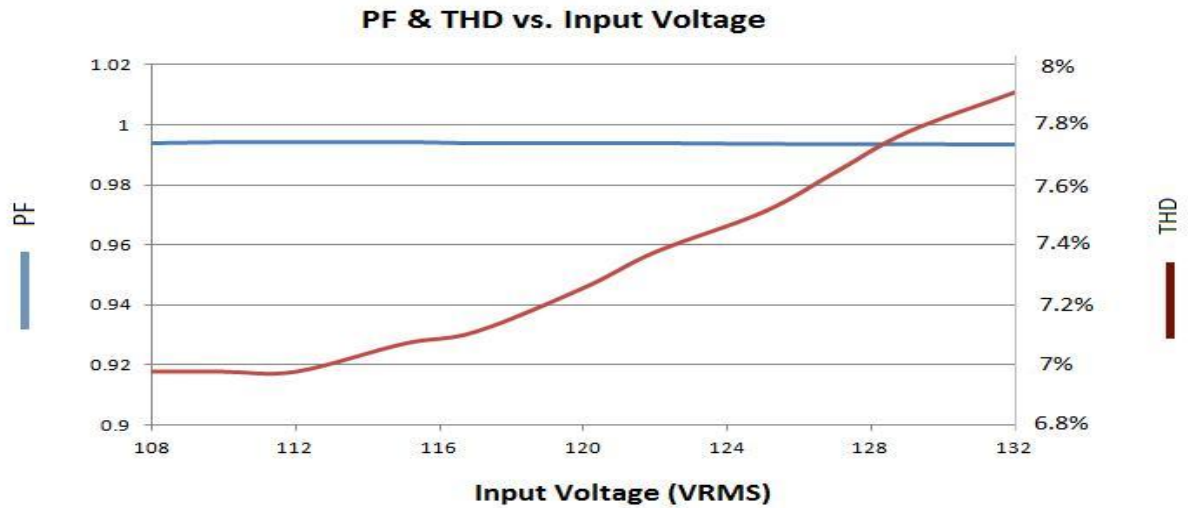

Figure 8 Power Factor & THD vs. Input Voltage

6.4 Power MOSFET Waveforms

Being a Quasi-Resonant PWM mode controller, the ICL8002G operates at the boundary of DCM/CCM turning on the power MOSFET (Q4) when the voltage across its Drain to Source is close to zero. This significantly reduces capacitive switching loss of the power MOSFET during turn-on. The V_{DS} waveform displayed in Figure 9 shows a Quasi-resonant operation. The voltage waveform across sense resistors R4, R25 and R26 quantifies the current through power MOSFET Q4.

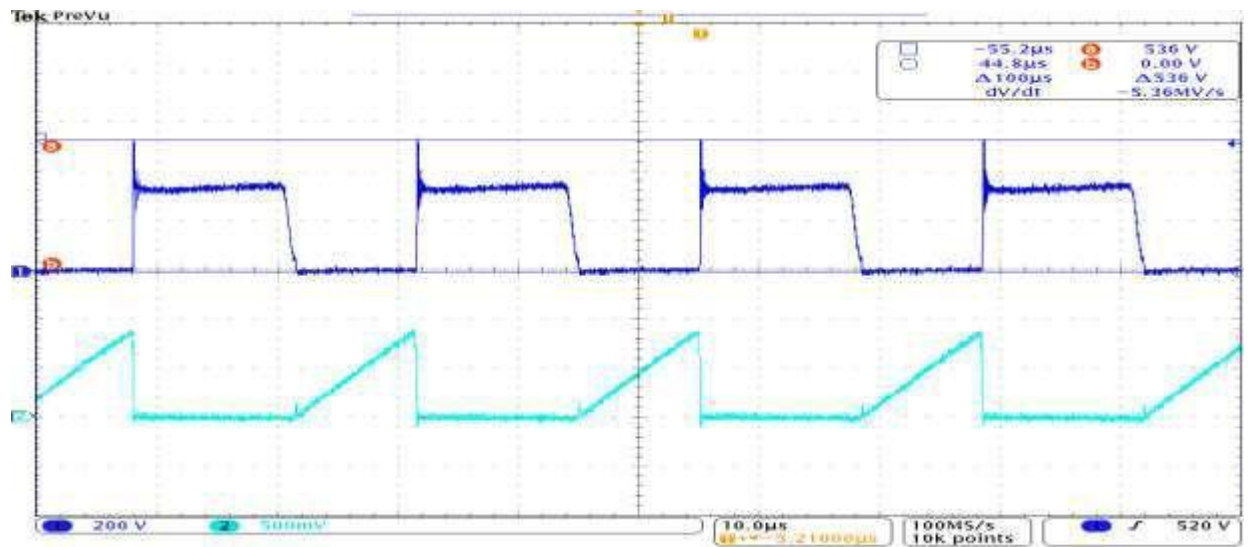

Figure 9 V_{DS} waveform of power MOSFET (CH1, Blue), Sense resistors (R4, R25 & R26) voltage (CH2, Turquoise).

6.5 Output

Since the PAR38 EVAL-LED-ICL8002G is a single stage design, it produces a ripple at twice the input voltage frequency. If a smaller LED current ripple is required, larger output capacitance can be used. The output capacitance in this demo board (C3 & C4) is sized for an output current ripple which exhibits no visible light modulation.

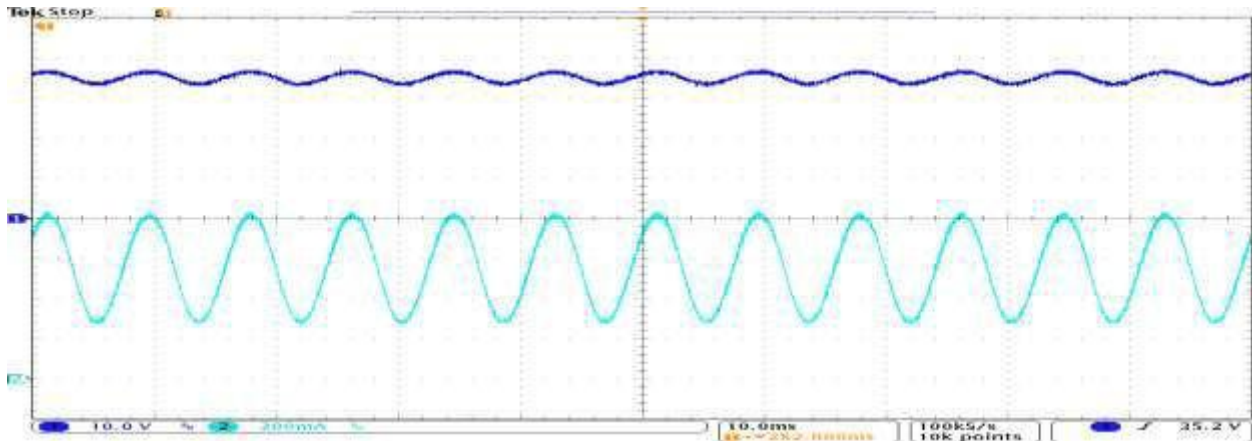

Figure 10 Output voltage waveform (CH1, Blue), Output Current (CH2, Turquoise)

If the user's target specification requires a different combination of output voltage and current than the existing demo board supports, minor modifications will be needed. The flyback topology can support a wide range of operation voltages and currents with changes to the transformer build and value changes for sense resistors R4, R25 and R26. **Infineon's Lightdesk** tool can help with these changes. Please go to www.infineon.com/Lightdesk and select AC/DC dimmable designs. Note: You will need to modify the auxiliary output voltage on the transformer to allow the use of the Vcc regulator that is included in this design. **Lightdesk's** design results use a default auxiliary voltage of approximately 19V so the number of turns on the auxiliary winding has to be increased proportionally. **Lightdesk's** calculated value to provide the target 30V auxiliary voltage output at full load.

6.6 Output Current Regulation

PAR38 EVAL-LED-ICL8002G mimics an incandescent light bulb with its output current changing in proportion to the input voltage variation. The output voltage and current shown below in figure 11 is for a 39V LED load.

PAR38 EVAL-LED-ICL8002G

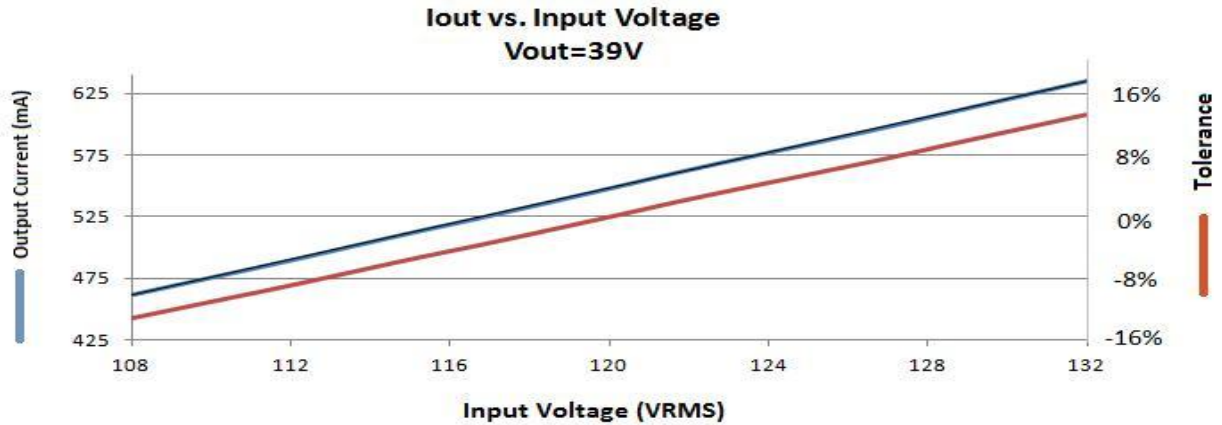

Figure 11 Output Current vs. Input Voltage variations

The demo board is capable of driving an output LED string with a voltage range between 32 to 40V across the output. The effect on the output current over this range of output voltages is shown in figure 12.

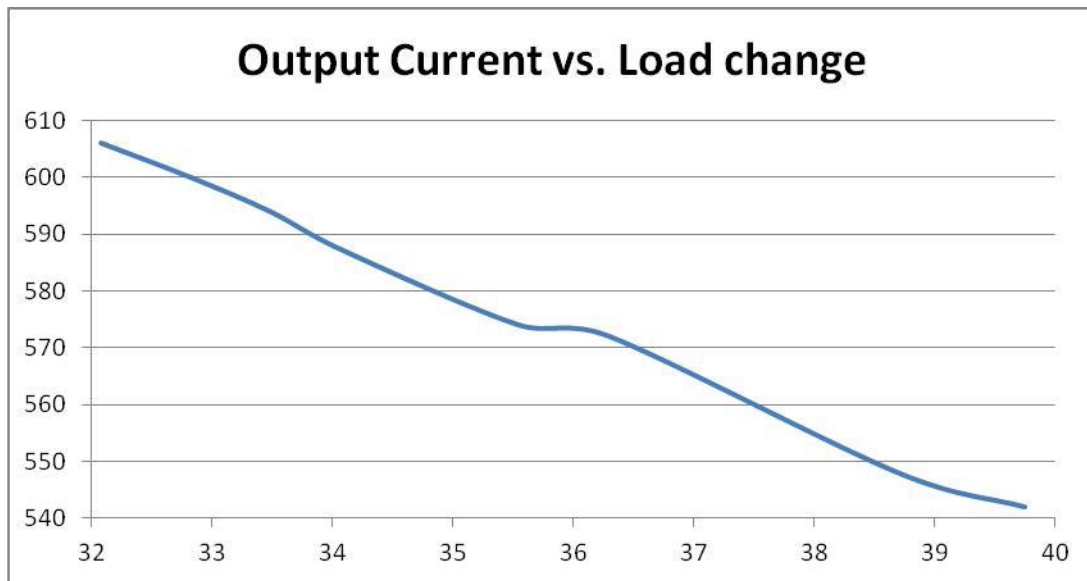

Figure 12 Output Current vs. Output Voltage variations

If the performance shown in figure 11 and 12 is not acceptable for your end application; the feed-forward circuit of figure 13 can be implemented to improve output current regulation due to output voltage and input voltage variations. The below circuit could provide a line and load regulation of less than 5% over the conditions shown in figure 11 and 12 above

PAR38 EVAL-LED-ICL8002G

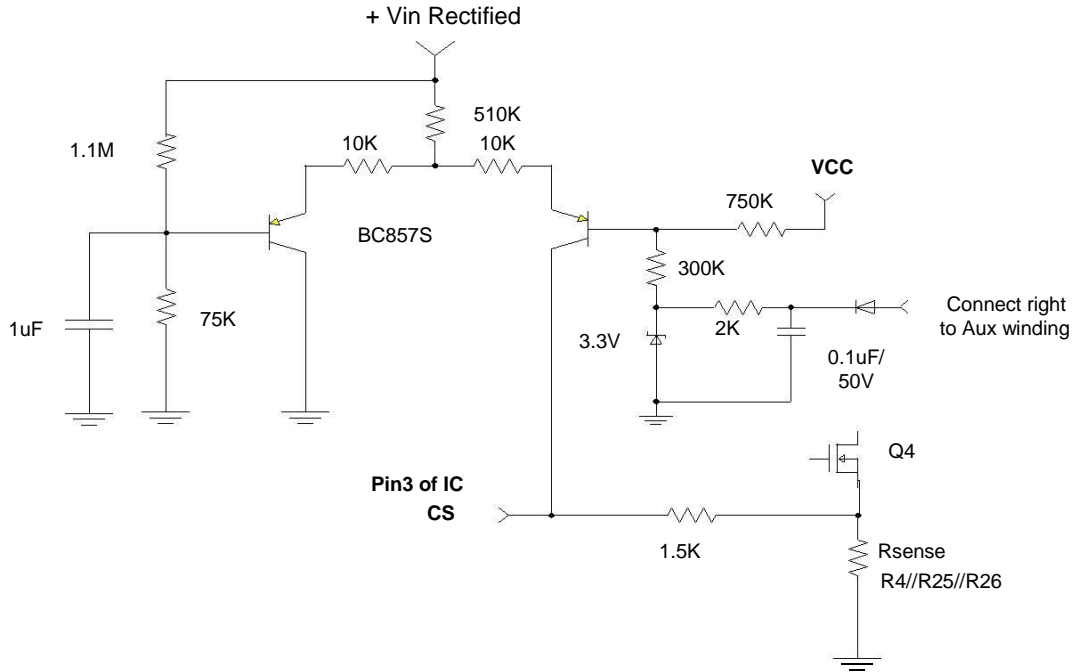

Figure 13 Feed-forward Circuit for Output Current Regulation due to LED V_f and Line Variations.

6.7 LED Open Load Protection

The ICL8002G provides protection against open loads via pin ZCV. When open load occurs (output current drops to zero), the output voltage will rise. The auxiliary bias voltage (C13) is coupled to the secondary. When the voltage at pin ZCV reaches the OVP threshold ($V_{zcovp}=3.7V$) the IC will stop switching and latches off. Power recycling of the input is required to restart the LED driver.

PAR38 EVAL-LED-ICL8002G

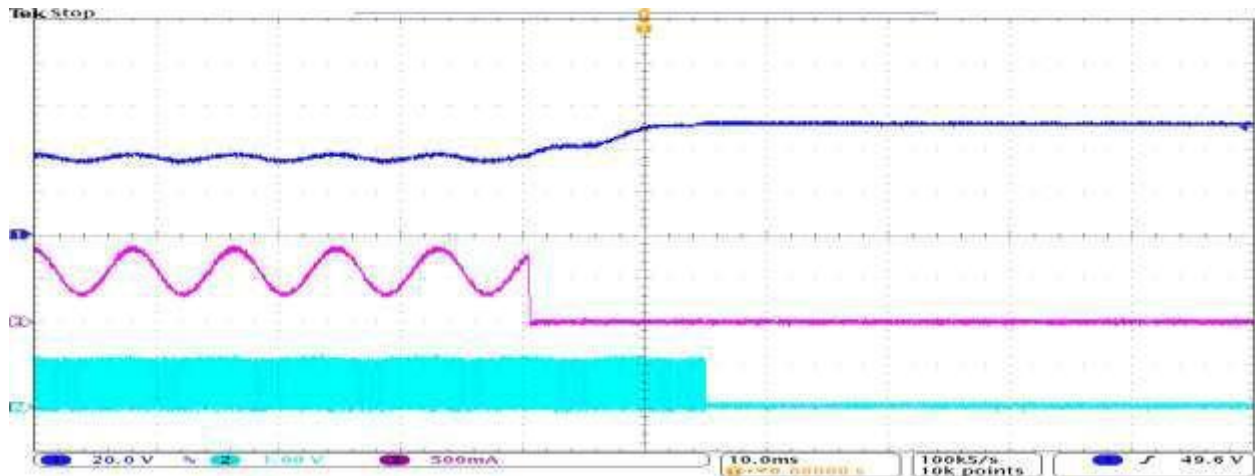

Figure 14 Output voltage (CH1, Blue), Gate of Q4 (CH2, Turquoise), Output Current (CH3, Pink)

6.8 Output Short Circuit Protection

In case of a short circuit at the output, the voltage at Vcc pin will drop below the under voltage threshold activating the Auto Restart mode.

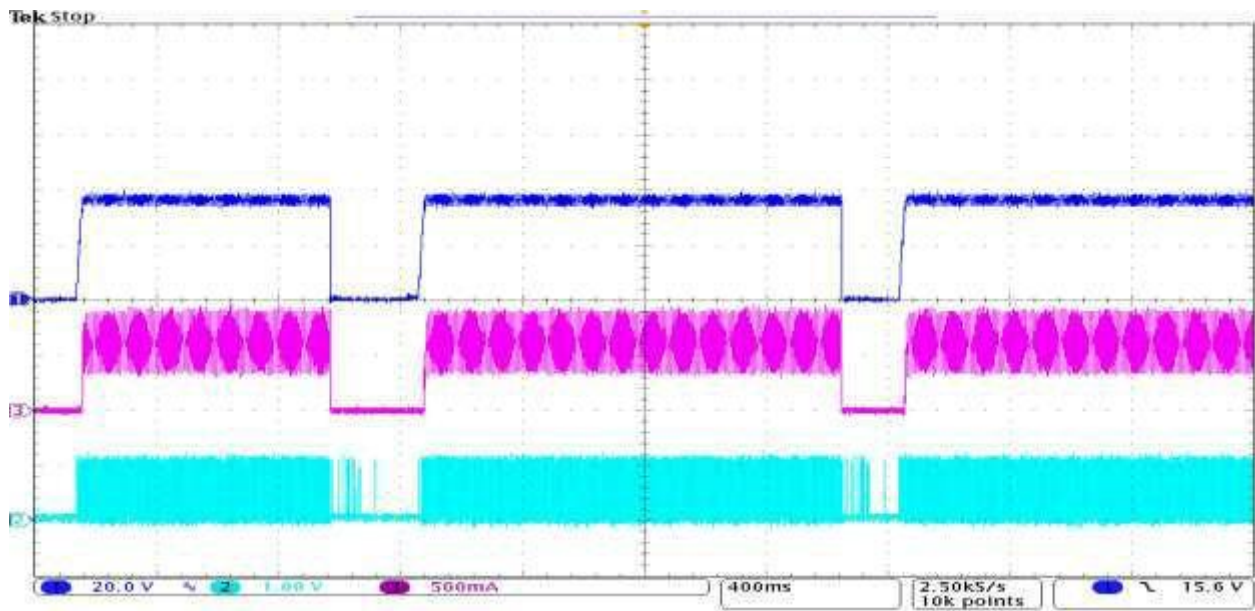

Figure 15 Output voltage (CH1, Blue), Gate of Q4 (CH2, Turquoise), Output Current (CH3, Pink)

7 Dimming

The ICL8002 delivers a smooth dimming curve that transitions from full light output to minimum dimming as shown in Figure 16.

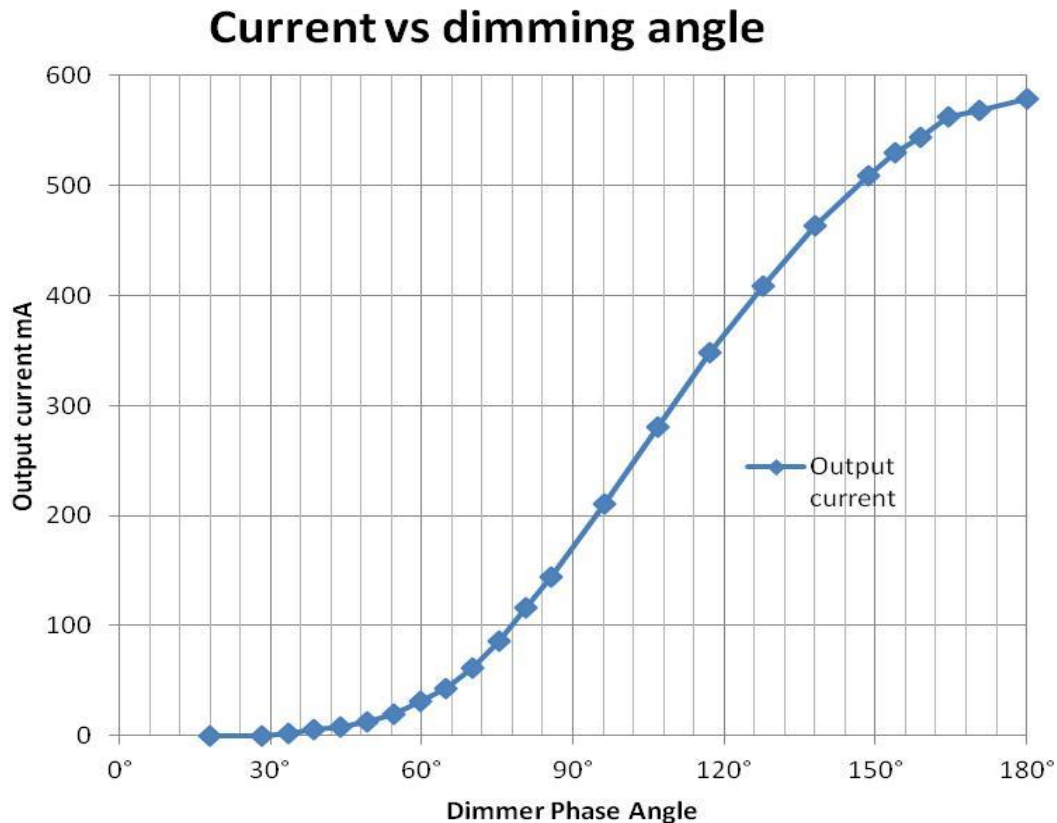

Figure 16 Output current vs Dimmer Phase angle

We have tested this evaluation board for dimming performance resulting in the list of dimmers below that exhibit no flicker or shimmer. This list of dimmers does not represent the complete list of supported dimmers; but rather a selection of commonly used and available dimmers in the North American market. Active damping, Vcc regulation, and an active bleeder (see schematic) were used in the design of the PAR38 to maximize dimming performance. If a small fixed list of dimmers, or a non dimming solution is required; then these blocks can be deleted and the passive circuits tuned to maximize the fixed dimmer list. This will result in a significantly reduced BOM count and lower cost.

PAR38 EVAL-LED-ICL8002G

Manufacturer	Dimmer P/N
LEVITON	CAT. NO. 6683
LEVITON	CAT. NO. 6684
LEVITON	CAT. NO. 6161
LEVITON	CAT. NO. IPI06-1LX
LEVITON	CAT. NO. IPI06
LEVITON	6631-LW
LUTRON	CN-600 PHW
LUTRON	DV603PG-WH
LUTRON	D-600P-WH
LUTRON	LG-600PH-WH
LUTRON	LX-600PL-WH
LUTRON	LXLV-600PL-WH
LUTRON	MAW-600H-WH
LUTRON	MCU04
LUTRON	NF-603P-WH
LUTRON	S-600-WH
LUTRON	S-600P-WH
LUTRON	S-603PG-WH
LUTRON	TG-600 PH-WH
LUTRON	TGLV-600PR-WH
LUTRON	4YPH5
LUTRON	5PWL6
LUTRON	AY-600 PNL
GE	GE 0723
COOPER	COOPER 47Y

Table 2 Dimmer List

The transformer auxiliary ratios must be changed if this board is used with a load that is less than 32V at full rated current. If less than 32V of LED load is applied without changing the auxiliary winding the solution may flicker due to loss of Vcc supply voltage. Vcc voltage is proportional to the output voltage. Please see the comments in section 6.5 regarding how to change the design to deliver different output voltages and currents.

8 Board Layout

A two layer PCB with 37.4mm x 87.2mm dimensions and a thickness of 1.5mm is used for the PAR38 EVAL-LED-ICL8002G. There is sufficient creepage between primary and secondary circuits to meet class 2 insulation requirements.

PAR38 EVAL-LED-ICL8002G

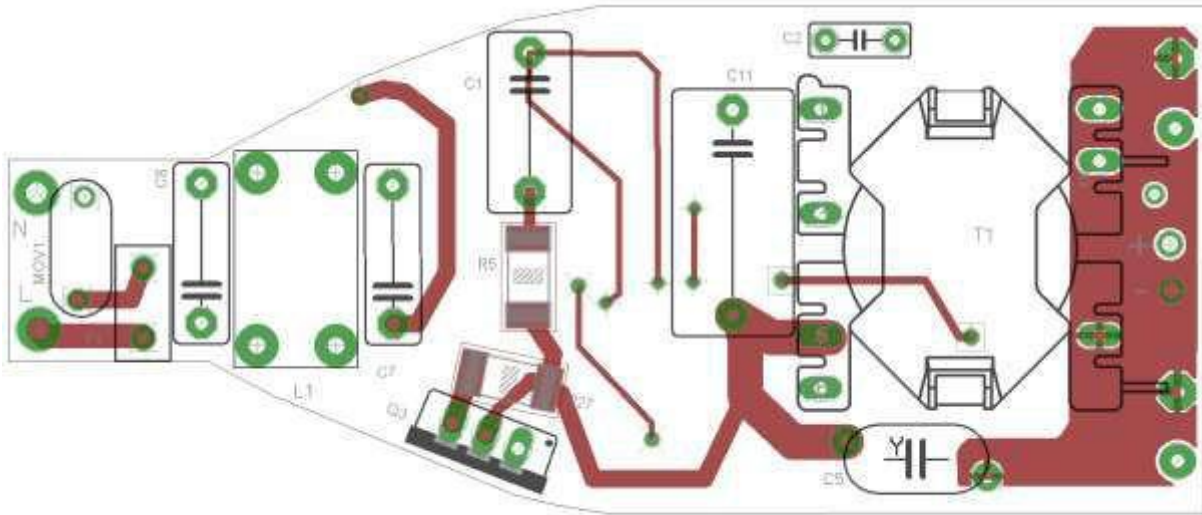

Figure 17 Top Side

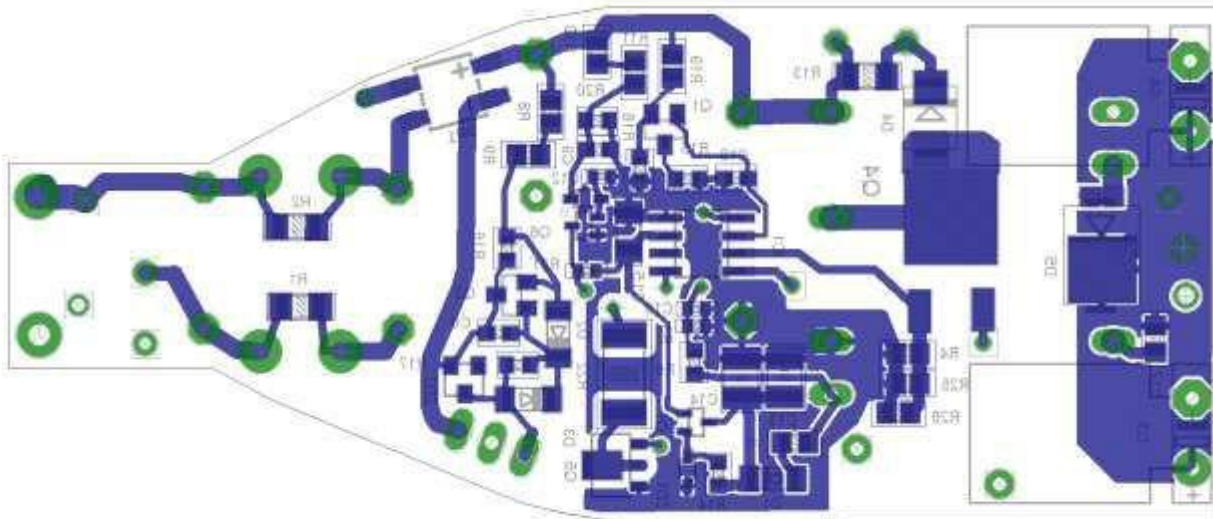

Figure 18 Bottom Side

9 Bill of Materials

Component	Value	Manufacturer	Manufacturer Part Number
F1	Fuse, FUSE 1.6A T-LAG IEC	BELL FUSE	RST 1.6AMMO
MOV1	VARISTOR 150VRMS 10mm RADIAL	EPCOS	S10K150
C1	CAP 0.33uF 250V METAL	EPCOS	B32521C3334J

PAR38 EVAL-LED-ICL8002G

	POLY		
C2	2.2nF 630V METAL POLY	EPCOS	B32529C8222J
C3, C4	CAP 220uF 50V ELECT RADIAL	SUNCON	50ME220CA
C5	Y CAP CER 1500pF 1KVDC RAD	VISHAY	VY1152M41Y5UQ 63V0
C6	CAP CER 47nF 25V X7R 20% 0603	MURATA	GRM188R71E473 KA01D
C7	X2 cap 33nF 305VAC	EPCOS	B32921C3333M
C8	X2 cap 10nF 305VAC	EPCOS	B32921C3103M
C9	CAP CER 47pF 50V COG 0603	MURATA	GRM39COG470J 50
C11	CAP 0.1uF 305VAC	EPCOS	B32922C3104M
C12	CAP CER 1000pF 50V COG 0402	MURATA	GRM1555C1H102 JA01D
C13, C14	CAP CER 10uF X7S 50V 1210	TDK Corporation	C3225X7S1H106 M
C15, C17	CAP CER 1uF 50V X7R 0805	MURATA	GRM31CR71E106 KA12
C16	CAP CER 220pF 50V X7R 0402	MURATA	GRM155R71H221 KA01D
C18	CAP CER 1000pF 50V 5% COG 0603	MURATA	GRM1885C1H102 JA01
L1	COMMON MODE INDUCTOR 6mH	WURTH ELECTRONICS	750 311 895
T1	1.5mH	WURTH ELECTRONICS	750312496
R1, R2	RES 4.7KΩ 1/4W 5% 1206 SMD	ANY	
R3	RES 3.01KΩ 1% 0402 SMD	ANY	
R4	RES 3.01Ω 1% 0805 SMD	ANY	
R5, R27	RES 220Ω 1W 5% 2512 SMD	VISHAY/DALE	CRCW2512820RJ NEG
R6	RES 26.7KΩ 1% 0603 SMD	ANY	
R7	RES 10Ω 1/8W 5% 0805 SMD	ANY	
R8-R11	RES 750KΩ, 1/8W 5% 0805 SMD	VISHAY/DALE	CRCW0805750KJ NEA
R13	RES 2MΩ 1/4W 5% 1206 SMD	ANY	
R14	RES 100KΩ 1/10W 5% 0603 SMD	ANY	
R15	RES 10.0KΩ 1/10W 1% 0603 SMD	VISHAY/DALE	CRCW060310K0F KEA
R16	RES 402KΩ 1/10W 1% 0603 SMD	VISHAY/DALE	CRCW06032M10 FKEA

PAR38 EVAL-LED-ICL8002G

R17	RES 22Ω 1/10W 5% 0603 SMD	ANY	
R18	RES 3.92KΩ, 1/10W 1% 0603 SMD	VISHAY/DALE	CRCW06033K92F KEA
R19	RES 240KΩ 1/8W 1% 0805 SMD	ANY	
R20	RES 604KΩ 1/10W 1% 0603 SMD	ANY	
R21	RES 100KΩ 5% 0402 SMD	ANY	
R22	RES 3.6KΩ 1W 5% 2512 SMD	VISHAY/DALE	CRCW25123K60J NEG
R25	RES 0.91Ω 1/8W 1% 0805 SMD	ANY	
R26	RES 6.81Ω 1% 0805 SMD	ANY	
U1	ICL8002G, P-DSO-8	Infineon	ICL8002G
BR1	RECT BRIDGE GPP 400V 0.8A MBS-1, 4-SOIC	Comchip Technology	B4S-G
D1	DIODE GP 200V 250mA MINIMELF	Micro Commercial Co	BAV102-TP
D2, D3	DIODE SWITCH SW 75V .5A MINIMELF	Micro Commercial Co	DL4151-TP
D4	DIODE SUPER FAST 1A 600V SMA	MICRO COMMERCIAL	ES1J-LTP
D5	DIODE SCHOTTKY 100V 10A, SMPC	VISHAY	V10P10
ZD1	DIODE ZENER 18V 150mW SOD-323	Diodes Inc	DDZ9705S
ZD2	DIODE ZENER 12V 350mW SOT23-3	Diodes Inc	BZX84C12-7-F
ZD3	DIODE ZENER 6.8V 150mW SOD-323	Diodes Inc	DDZ9692S-7
Q1	TRANS PNP BIPOLAR 65V SOT23-BEC	Diodes Inc	BC856B-7-F
Q2	TRANS PNP BIPOLAR 300V SOT23-3	Diodes Inc	MMBTA92-7-F
Q3	MOSFET N type, 600V , 190mΩ	INFINEON	IPI60R190C6
Q4	600mΩ 600VOLT MOSFET, DPAK	INFINEON	IPD60R600C6
Q5	45Ω 600VOLT MOSFET, SOT89	INFINEON	BSS225
Q6, Q7	TRANS NPN BIPOLAR 65V SOT323	Diodes Inc.	BC846BW-7-F

Table 3 Bill of Materials

10 Transformer

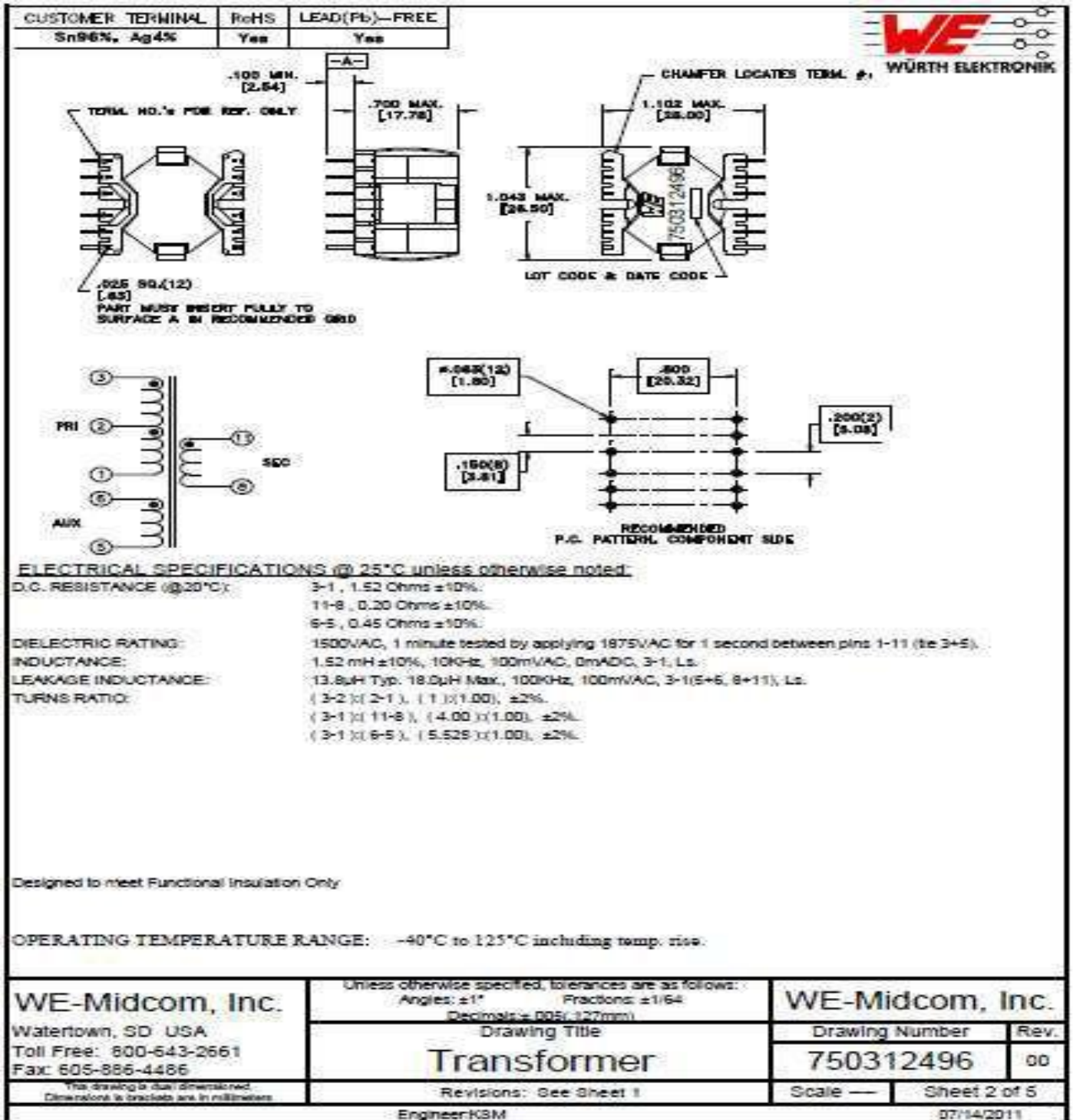

Figure 19: Transformer

PAR38 EVAL-LED-ICL8002G

The PCB layout is designed for Class 2 insulation. However, this transformer used on this evaluation board is **not** designed for Class 2 isolation. If class2 insulation is required please contact a custom magnetic supplier for assistance in this design or use our design tool at www.infineon.com/lightdesk. Many options are available for core and bobbins to provide Class 2 isolation. For example, the pin-out of the PQ20/16 is very similar to the RM8 and provides better form factor with more creepage for class2 insulation than the RM8 bobbin.

11 Related Documentation at Infineon

ICL8002G Datasheet:

<http://www.infineon.com/cms/en/product/channel.html?channel=db3a3043266237920126b71e3a221e91>

Design Guidelines ICL8001G/ ICLS8082:

<http://www.infineon.com/dgdl?folderId=db3a304314dca389011561889ef01fe7&fileId=db3a30432a7fedfc012a8e9ff4d40493>

Infineon Light Desk Design Tool: www.infineon.com/Lightdesk

Infineon CoolMOS™ **High voltage** mosfets: www.infineon.com/coolmos

Infineon OptiMOS™ Mid / low voltage Mosfets: www.infineon.com/optimos

Demo board Order code: SP000993130

www.infineon.com