

High Voltage NPN Transistor

FEATURES

- Low spread of dynamic parameters
- High switching speed
- Low base drive requirement
- Compliant to RoHS Directive 2011/65/EU and in accordance to WEEE 2002/96/EC.
- Halogen-free according to IEC 61249-2-21

APPLICATION

- Ballast Lighting
- Charger

KEY PERFORMANCE PARAMETERS			
PARAMETER		VALUE	UNIT
BV _{CEO}		400	V
BV _{CBO}		700	V
I _C		3	A
V _{CE(SAT)}	I _C =1A, I _B =0.2A	0.17	V

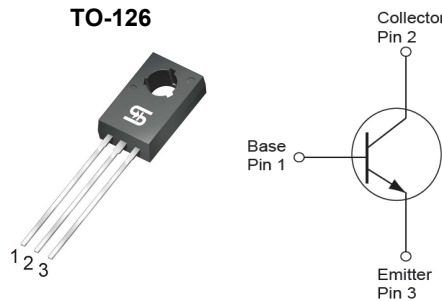

ABSOLUTE MAXIMUM RATINGS (T _A = 25°C unless otherwise noted)			
PARAMETER	SYMBOL	LIMIT	UNIT
Collector-Base Voltage	V _{CBO}	700	V
Collector-Emitter Voltage @ V _{BE} =0V	V _{CES}	700	V
Collector-Emitter Voltage	V _{CEO}	400	V
Emitter-Base Voltage	V _{EBO}	9	V
Collector Current	I _C	3	A
Collector Peak Current (tp <5ms)	I _{CM}	6	A
Base Current	I _B	1.5	A
Base Peak Current (tp <5ms)	I _{BM}	3	A
Power Total Dissipation @ T _C =25°C	P _{DTOT}	20	W
Maximum Operating Junction Temperature	T _J	+150	°C
Storage Temperature Range	T _{STG}	-55 to +150	°C

THERMAL PERFORMANCE			
PARAMETER	SYMBOL	LIMIT	UNIT
Junction to Case Thermal Resistance	R _{θJC}	6.25	°C/W

ELECTRICAL SPECIFICATIONS ($T_A = 25^\circ\text{C}$ unless otherwise noted)						
PARAMETER	CONDITIONS	SYMBOL	MIN	TYP	MAX	UNIT
Static (Note 1)						
Collector-Base Voltage	$I_C = 1\text{mA}, I_B = 0$	BV_{CBO}	700	--	--	V
Collector-Emitter Breakdown Voltage	$I_C = 10\text{mA}, I_E = 0$	BV_{CEO}	400	--	--	V
Emitter-Base Breakdown Voltage	$I_E = 1\text{mA}, I_C = 0$	BV_{EBO}	9	--	--	V
Collector Cutoff Current	$V_{CB} = 700\text{V}, I_E = 0$	I_{CBO}	--	--	10	A
Collector Cutoff Current	$V_{CE} = 400\text{V}, I_B = 0$	I_{CEO}	--	--	10	μA
Emitter Cutoff Current	$V_{EB} = 7\text{V}, I_C = 0$	I_{EBO}	--	--	10	μA
Collector-Emitter Saturation Voltage	$I_C = 0.4\text{A}, I_B = 0.1\text{A}$	$V_{CE(SAT)1}$	--	0.10	0.7	V
	$I_C = 1\text{A}, I_B = 0.2\text{A}$	$V_{CE(SAT)2}$	--	0.17	1.0	
	$I_C = 2.5\text{A}, I_B = 0.5\text{A}$	$V_{CE(SAT)3}$	--	0.55	1.5	
Base-Emitter Saturation Voltage	$I_C = 1\text{A}, I_B = 0.2\text{A}$	$V_{BE(SAT)1}$	--	--	1.1	V
	$I_C = 2\text{A}, I_B = 0.5\text{A}$	$V_{BE(SAT)2}$	--	--	1.2	
DC Current Gain	$V_{CE} = 5\text{V}, I_C = 10\text{mA}$	h_{FE}	10	--	--	
	$V_{CE} = 5\text{V}, I_C = 1\text{A}$		15	--	30	
	$V_{CE} = 5\text{V}, I_C = 2\text{A}$		5	--	--	
	$V_{CE} = 2\text{V}, I_C = 0.425\text{A}$		24	--	--	
Forward Voltage Drop	$I_F = 2\text{A}$	V_F	--	--	2.0	V
Resistive Load Switching Time (Note 2)						
Turn On Time	$V_{CC} = 250\text{V}, I_C = 1\text{A}, I_{B1} = I_{B2} = 0.2\text{A}, t_p = 25\mu\text{s}$ Duty Cycle < 1%	t_{ON}	--	0.2	0.6	μs
Storage Time		t_{STG}	--	2.7	4.5	μs
Fall Time		t_f	--	0.16	0.3	μs

Notes:

- Pulse test: $\leq 380\mu\text{s}$, duty cycle $\leq 2\%$
- For DESIGN AID ONLY, not subject to production testing.

ORDERING INFORMATION

PART NO.	PACKAGE	PACKING
TS13005CK C0G	TO-126	50pcs / Tube

ELECTRICAL CHARACTERISTICS CURVES ($T_A=25^\circ\text{C}$, unless otherwise noted)

Figure 1. Safe Operation Area

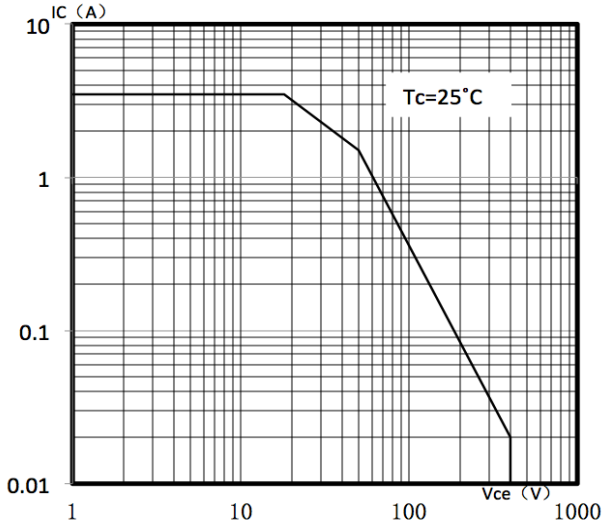

Figure 2. DC Current Gain

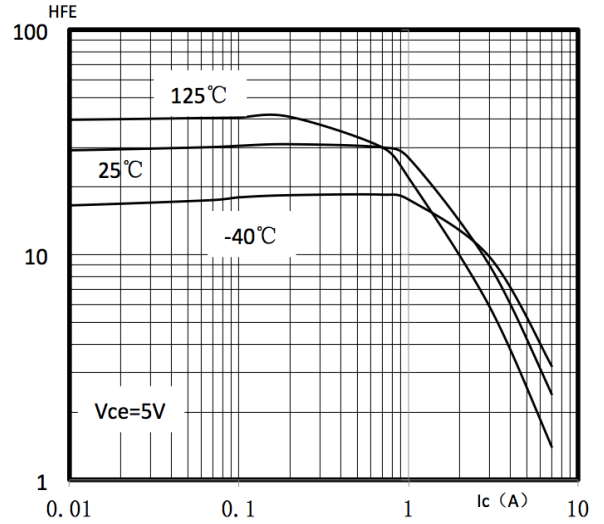

Figure 3. Vce(sat) vs. IC

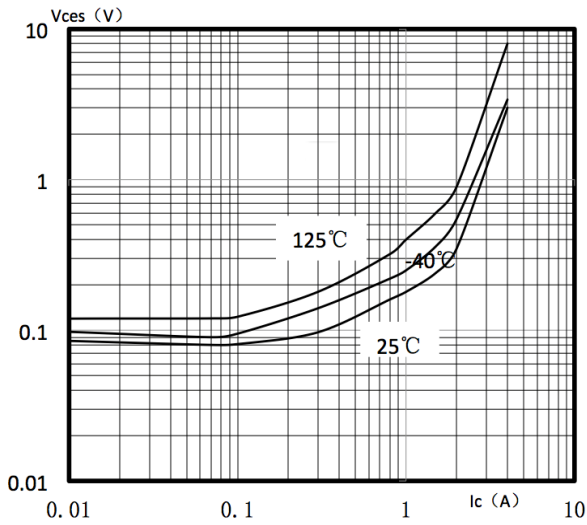

Figure 4. Vbe(sat) vs. IC

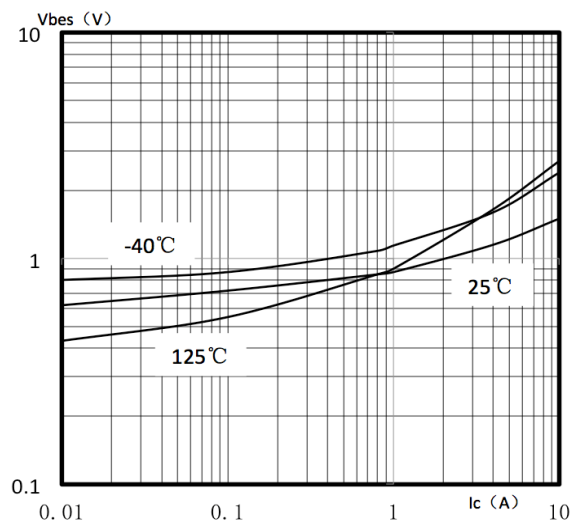
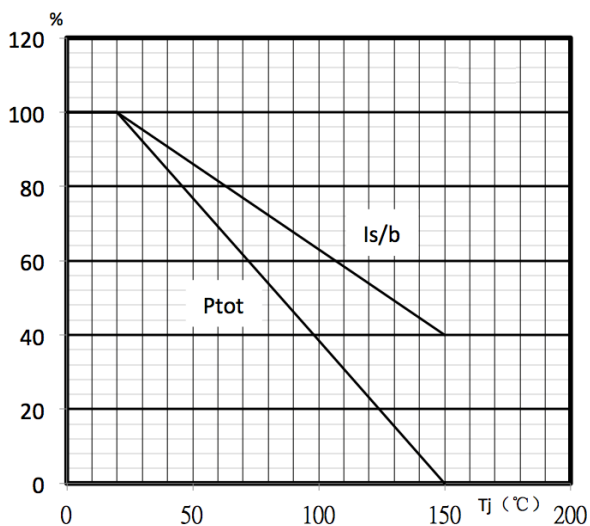
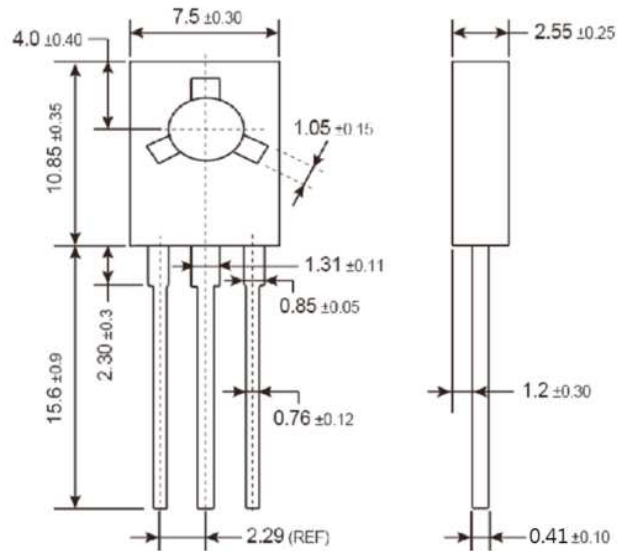

Figure 5. Power Derating



PACKAGE OUTLINE DIMENSIONS (Unit: Millimeters)

TO-126



MARKING DIAGRAM

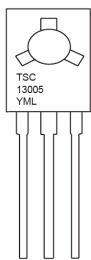

- Y** = Year Code
- M** = Month Code for Halogen Free Product
 - O** =Jan **P** =Feb **Q** =Mar **R** =Apr
 - S** =May **T** =Jun **U** =Jul **V** =Aug
 - W** =Sep **X** =Oct **Y** =Nov **Z** =Dec
- L** = Lot Code

Notice

Specifications of the products displayed herein are subject to change without notice. TSC or anyone on its behalf, assumes no responsibility or liability for any errors or inaccuracies.

Information contained herein is intended to provide a product description only. No license, express or implied, to any intellectual property rights is granted by this document. Except as provided in TSC's terms and conditions of sale for such products, TSC assumes no liability whatsoever, and disclaims any express or implied warranty, relating to sale and/or use of TSC products including liability or warranties relating to fitness for a particular purpose, merchantability, or infringement of any patent, copyright, or other intellectual property right.

The products shown herein are not designed for use in medical, life-saving, or life-sustaining applications. Customers using or selling these products for use in such applications do so at their own risk and agree to fully indemnify TSC for any damages resulting from such improper use or sale.