



Military COTS 270 V_{IN} Filter

M-FIAM3

Model Number **M-FIAM3M21***

Actual size:
2.28 x 2.2 x 0.5in
57,9 x 55,9 x 12,7mm

Input Attenuator Module

Features & Benefits

- EMI filtering-MIL-STD-461E ^[1]
- Transient protection-MIL-STD-704E/F
- Environments-MIL-STD-810, MIL-STD-202
- Environmental stress screening
- Low profile mounting options
- Output current up to 3A
- Mini sized package
- Inrush current limiting

Product Highlights

The M-FIAM3 is a DC front-end module that provides EMI filtering and transient protection. The M-FIAM3 enables designers using Vicor's Maxi, Mini, Micro Series 300V DC-DC converters to meet conducted emission/conducted susceptibility per MIL-STD-461E; and input transients per MIL-STD-704E/F. The M-FIAM3 accepts an input voltage of 180 – 375V_{DC} and delivers output current up to 3A.

M-FIAM3 is housed in an industry standard "half brick" module measuring 2.28" x 2.2" x 0.5" and depending upon model selected, may be mounted on-board or in-board for height critical applications.

Compatible Products

- Maxi, Mini, Micro Series 300V Input DC-DC converters

^[1] EMI performance is subject to a wide variety of external influences such as PCB construction, circuit layout etc. External components in addition to those listed herein may be required in specific instances to gain full compliance to the standards specified at various line and load conditions.

Absolute Maximum Rating

Parameter	Rating	Unit	Notes
+IN to -IN	375	V _{DC}	Continuous
	400	V _{DC}	100ms
Mounting torque	5 (0.57)	in-lbs	6 each, #4-40 or M3
Pin Soldering temperature	500 (260)	°F (°C)	<5sec; wave solder
	750 (390)	°F (°C)	<7sec; hand solder

Thermal Resistance and Capacity

Parameter	Min	Typ	Max	Unit
Baseplate to sink				
	flat, greased surface		0.16	°C/Watt
	with thermal pad (P/N 20264)		0.1	°C/Watt
Baseplate to ambient				
	Free convection		7.9	°C/Watt
1000LFM		2.2	°C/Watt	

MTBF per MIL-HDBK-217F (M-FIAM3M21)

Temperature	Environment	MTBF	Unit
25°C	Ground Benign: G.B.	13,291	1,000Hrs
50°C	Naval Sheltered: N.S.	2,392	1,000Hrs
65°C	Airborne Inhabited Cargo: A.I.C.	1,874	1,000Hrs

Part Numbering

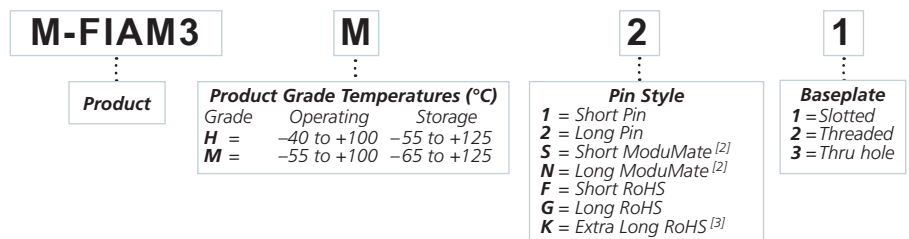

^[2] Compatible with SurfMate and InMate socketing system

^[3] Not intended for socket or Surfmate mounting

Specifications

(Typical at $T_{BP} = 25^{\circ}\text{C}$, nominal line and 75% load, unless otherwise specified)

INPUT SPECIFICATIONS

Parameter	Min	Typ	Max	Unit	Notes
Input voltage	180	270	375	V_{DC}	Continuous
Inrush limiting			0.018	A/ μF	
Transient immunity					Exceeds limits of MIL-STD-704E/F

OUTPUT SPECIFICATIONS

Parameter	Min	Typ	Max	Unit	Notes
Output current			3	A	
Efficiency	96	98		%	
Internal voltage drop		3.0	5.0	V	@ 3A, 100°C baseplate
External capacitance	10		22	μF	See Figure 5 on page 4. 400V

CONTROL PIN SPECIFICATIONS

Parameter	Min	Typ	Max	Unit	Notes
ON/OFF control					
Enable (ON)	0.0		1.0	V_{DC}	Referenced to $-V_{OUT}$
Disable (OFF)	3.5		5.0	V_{DC}	100k Ω internal pull-up resistor

SAFETY SPECIFICATIONS

Parameter	Min	Typ	Max	Unit	Notes
Dielectric withstand	1,500			V_{RMS}	Input/Output to Base
	2,121			V_{DC}	Input/Output to Base

EMI

Standard	Test Procedure	Notes
MIL-STD-461E		
Conducted emissions:	CE101, CE102	
Conducted susceptibility:	CS101, CS114, CS115, CS116	

EMI performance is subject to a wide variety of external influences such as PCB construction, circuit layout etc. As such, external components in addition to those listed herein may be required in specific instances to gain full compliance to the standards specified.

Specifications (Cont.)

GENERAL SPECIFICATIONS

Parameter	Min	Typ	Max	Unit	Notes
Weight		3.3 (94)		Ounces (grams)	
Warranty			2	Years	

ENVIRONMENTAL QUALIFICATION

Altitude	MIL-STD-810F, Method 500.4, Procedure I & II, 40,000ft. and 70,000ft. Operational.
Explosive Atmosphere	MIL-STD-810F, Method 511.4, Procedure I, Operational.
Vibration	MIL-STD-810F, Method 514.5, Procedure I, Category 14, Sine and Random vibration per Table 514.5C for Helicopter AH-6J Main Rotor with overall level of 5.6Grms for 4 hours per axis. MIL-STD-810F, Method 514.5C, General Minimum Integrity Curve per Figure 514.5C-17 with overall level of 7.7Grms for 1 hour per axis.
Shock	MIL-STD-810F, Method 516.5, Procedure I, Functional Shock, 40g. MIL-S-901D, Lightweight Hammer Shock, 3 impacts/axis, 1,3,5 ft. MIL-STD-202F, Method 213B, 60g, 9ms half sine. MIL-STD-202F, Method 213B, 75g, 11ms Saw Tooth Shock.
Acceleration	MIL-STD-810F, Method 513.5, Procedure II, table 513.5-II, Operational, 2-7g, 6 directions.
Humidity	MIL-STD-810F, Method 507.4.
Solder Test	MIL-STD-202G, Method 208H, 8 hour aging.

ENVIRONMENTAL STRESS SCREENING

Parameter	H-Grade	M-Grade
Operating temperature	-40°C to +100°C	-55°C to +100°C
Storage temperature	-55°C to +125°C	-65°C to +125°C
Temperature cycling*	12 cycles -65°C to +100°C	12 cycles -65°C to +100°C
Ambient test @ 25°C	Yes	Yes
Power cycling burn-in	12 hours, 29 cycles	24 hours, 58 cycles
Functional and parametric ATE tests	-40°C and +100°C	-55°C and +100°C
Hi-Pot test	Yes	Yes
Visual inspection	Yes	Yes
Test data	vicorpower.com	vicorpower.com

*Temperature cycled with power off, 17°C per minute rate of change.

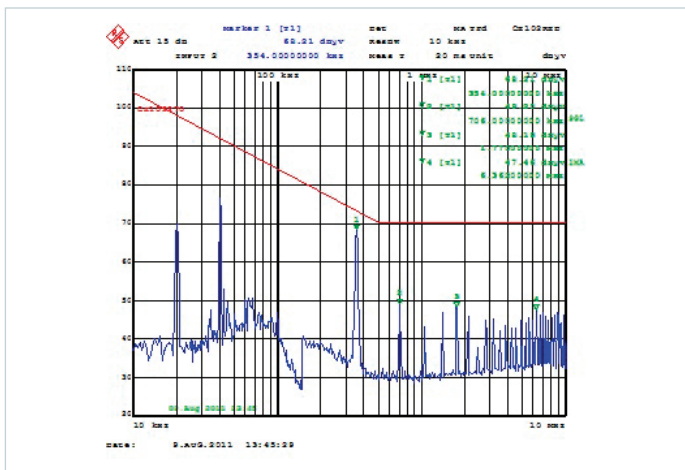

Figure 1 — Conducted noise; M-FIAM3 and V300A48C500BG DC-DC converter operating at 270V_{DC} input at 450W

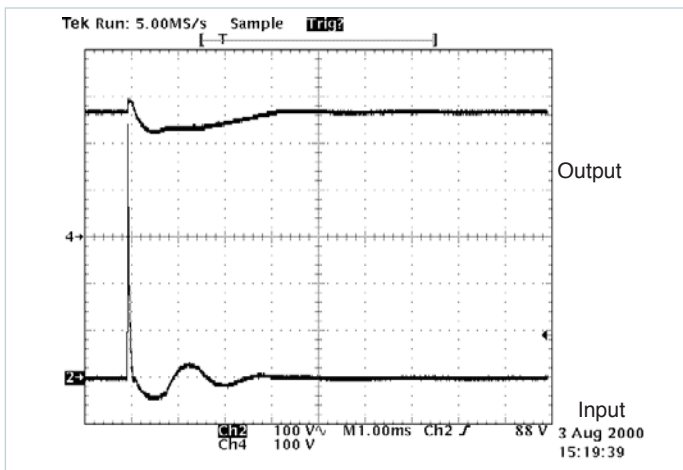

Figure 2 — Transient Immunity; M-FIAM3 output response to an input transient

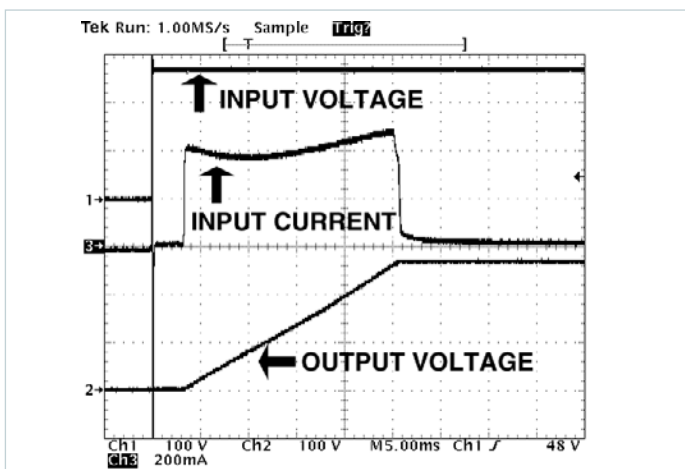

Figure 3 — Inrush Limiting; Inrush current with 22μF external capacitance, (C1 in Figure 5)

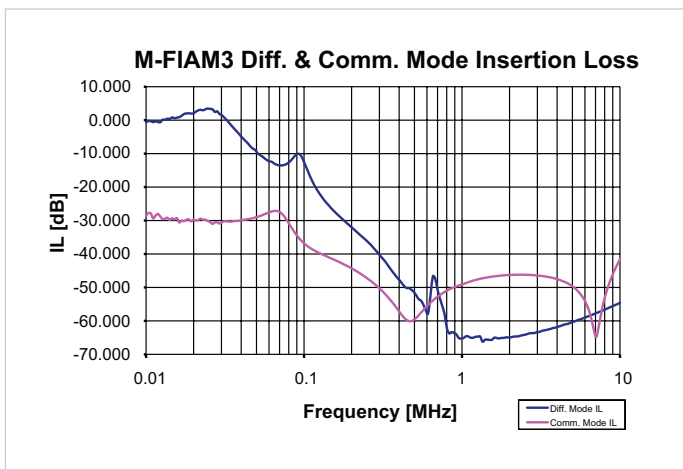

Figure 4 — Insertion Loss Curve

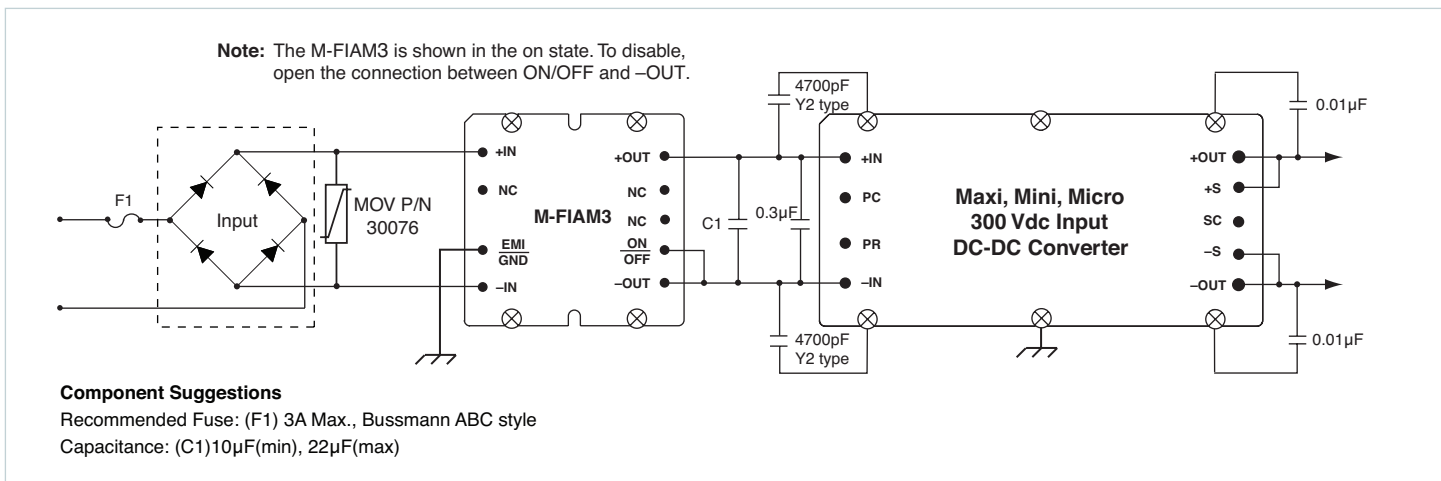

Figure 5 — Basic connection diagram with Transient, Surge Protection and Recommended Reverse Polarity Protection

Mechanical Drawings

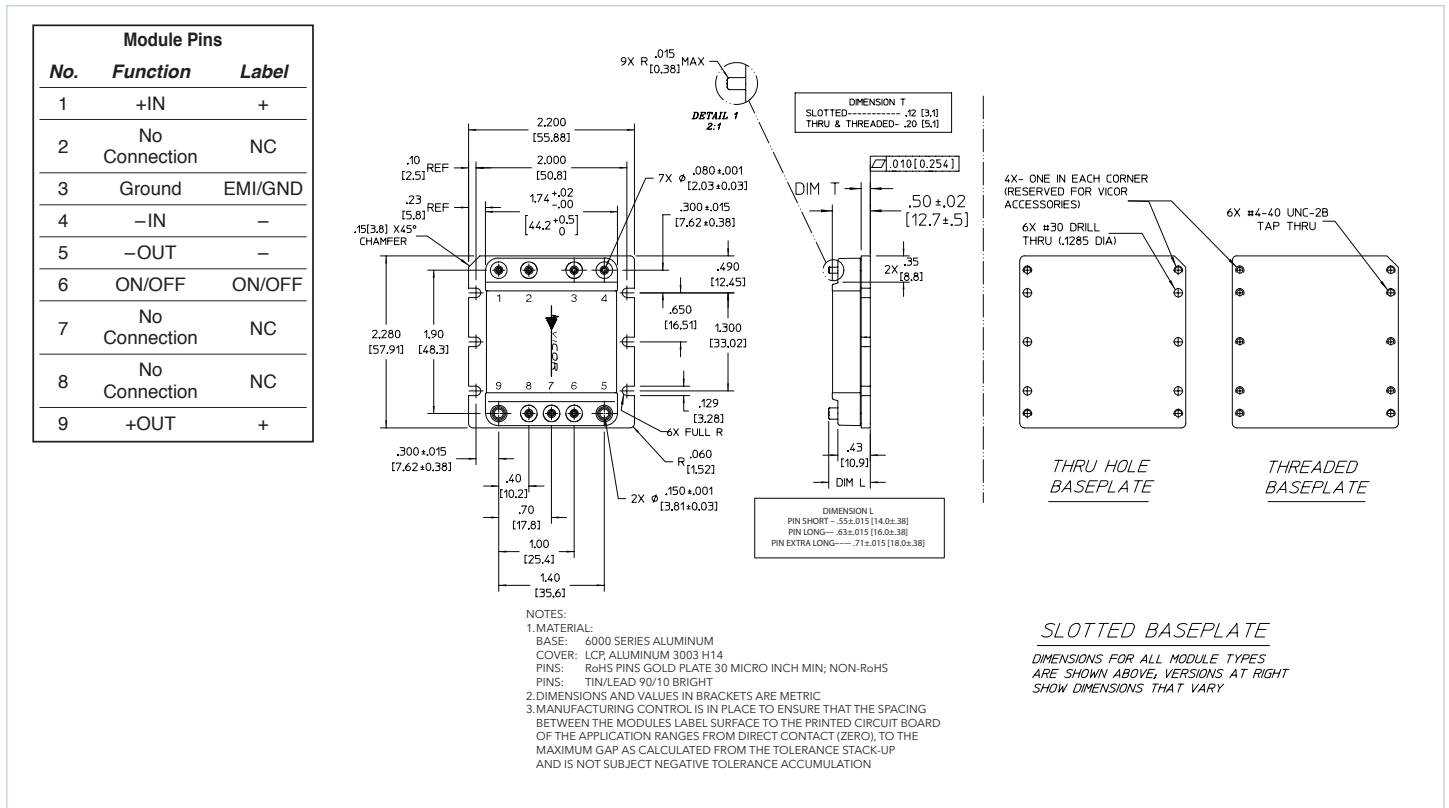

Figure 6 — Mechanical diagram

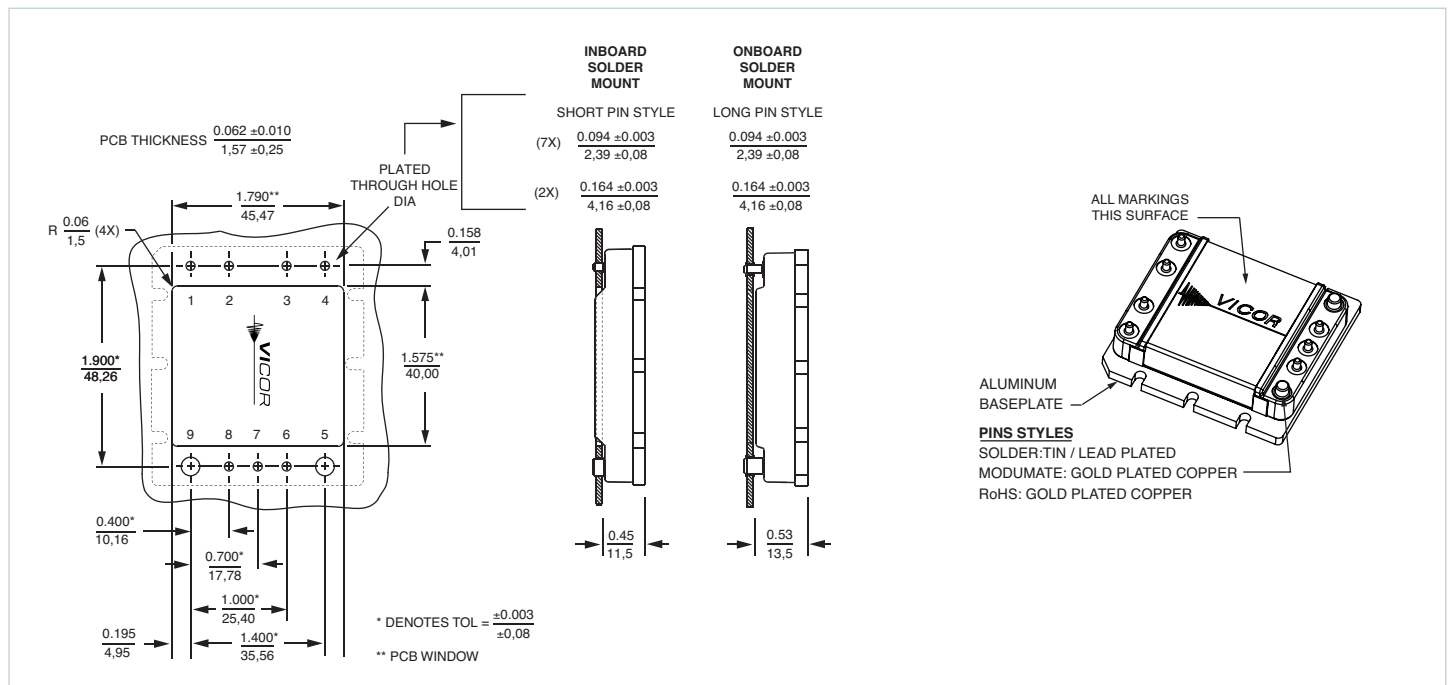

Figure 7 — PCB Mounting Specifications

Vicor's comprehensive line of power solutions includes high density AC-DC and DC-DC modules and accessory components, fully configurable AC-DC and DC-DC power supplies, and complete custom power systems.

Information furnished by Vicor is believed to be accurate and reliable. However, no responsibility is assumed by Vicor for its use. Vicor makes no representations or warranties with respect to the accuracy or completeness of the contents of this publication. Vicor reserves the right to make changes to any products, specifications, and product descriptions at any time without notice. Information published by Vicor has been checked and is believed to be accurate at the time it was printed; however, Vicor assumes no responsibility for inaccuracies. Testing and other quality controls are used to the extent Vicor deems necessary to support Vicor's product warranty. Except where mandated by government requirements, testing of all parameters of each product is not necessarily performed.

Specifications are subject to change without notice.

Vicor's Standard Terms and Conditions and Product Warranty

All sales are subject to Vicor's Standard Terms and Conditions of Sale, and Product Warranty which are available on Vicor's webpage (<http://www.vicorpower.com/termsconditionswarranty>) or upon request.

Life Support Policy

VICOR'S PRODUCTS ARE NOT AUTHORIZED FOR USE AS CRITICAL COMPONENTS IN LIFE SUPPORT DEVICES OR SYSTEMS WITHOUT THE EXPRESS PRIOR WRITTEN APPROVAL OF THE CHIEF EXECUTIVE OFFICER AND GENERAL COUNSEL OF VICOR CORPORATION. As used herein, life support devices or systems are devices which (a) are intended for surgical implant into the body, or (b) support or sustain life and whose failure to perform when properly used in accordance with instructions for use provided in the labeling can be reasonably expected to result in a significant injury to the user. A critical component is any component in a life support device or system whose failure to perform can be reasonably expected to cause the failure of the life support device or system or to affect its safety or effectiveness. Per Vicor Terms and Conditions of Sale, the user of Vicor products and components in life support applications assumes all risks of such use and indemnifies Vicor against all liability and damages.

Intellectual Property Notice

Vicor and its subsidiaries own Intellectual Property (including issued U.S. and Foreign Patents and pending patent applications) relating to the products described in this data sheet. No license, whether express, implied, or arising by estoppel or otherwise, to any intellectual property rights is granted by this document. Interested parties should contact Vicor's Intellectual Property Department.

Vicor Corporation

25 Frontage Road
Andover, MA, USA 01810
Tel: 800-735-6200
Fax: 978-475-6715

email

Customer Service: custserv@vicorpower.com

Technical Support: apps@vicorpower.com