

Programmable FTG for Differential P4™ CPU, PCI-Express & SATA Clocks

ICS9FG107

Description

ICS9FG107 is a Frequency Timing Generator that provides 7 differential output pairs that are compliant to the Intel CK409/CK410 specification. It provides support for PCI-Express, next generation I/O, and SATA. The part synthesizes several output frequencies from either a 14.31818 Mhz crystal or a 25 MHz crystal. The device can also be driven by a reference input clock instead of a crystal. It provides outputs with cycle-to-cycle jitter of less than 85 ps and output-to-output skew of less than 85 ps.

ICS9FG107 also provides a copy of the reference clock and 333 MHz PCI output clocks. Frequency selection can be accomplished via strap pins or SMBus control.

Features/Benefits

- Generates common CPU/PCI Express frequencies from 14.318 MHz or 25 MHz
- Crystal or reference input
- 7 - 0.7V current-mode differential output pairs
- 3 - 33MHz PCI outputs
- 1 - REFOUT
- Supports Serial-ATA at 100 MHz
- Two spread spectrum modes: 0 to -0.5 downspread and +/-0.25% centerspread
- Unused inputs may be disabled in either driven or Hi-Z state for power management.

Key Specifications

- Output cycle-to-cycle jitter for DIF outputs < 50 ps (<85ps @ 266 MHz)
- Output to output skew for DIF outputs < 85 ps
- +/-300 ppm frequency accuracy on output clocks
- 48-pin SSOP/TSSOP package
- Available in RoHS compliant packaging

Functional Block Diagram

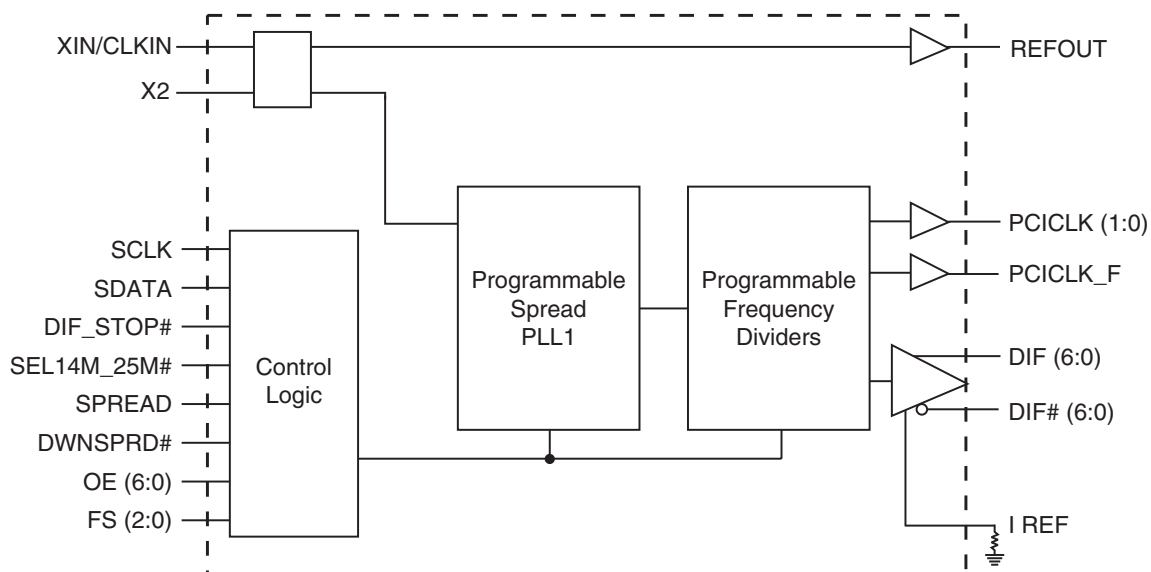

Pin Configuration

XIN/CLKIN	1	48	VDDA
X2	2	47	GND
VDD	3	46	IREF
GND	4	45	DWNSPRD#*
FS2/REFOUT*	5	44	FS1**
GND	6	43	OE_0*
FS0/PCICLK_F*	7	42	DIF_0
PCICLK0	8	41	DIF_0#
PCICLK1	9	40	VDD
VDD	10	39	DIF_1
OE_6**	11	38	DIF_1#
DIF_6	12	37	OE_1**
DIF_6#	13	36	VDD
VDD	14	35	GND
GND	15	34	OE_2**
OE_5**	16	33	DIF_2
DIF_5	17	32	DIF_2#
DIF_5#	18	31	VDD
VDD	19	30	DIF_3
DIF_4	20	29	DIF_3#
DIF_4#	21	28	OE_3*
OE_4*	22	27	SEL14M_25M#**
SDATA	23	26	SPREAD*
SCLK	24	25	DIF_STOP#

ICS9FG107

Functionality Table

SEL14M_25M# (FS3)	FS2	FS1	FS0	OUTPUT(MHz)
0	0	0	0	100.00
0	0	0	1	125.00
0	0	1	0	133.33
0	0	1	1	166.67
0	1	0	0	200.00
0	1	0	1	266.66
0	1	1	0	333.33
0	1	1	1	400.00
1	0	0	0	100.00
1	0	0	1	125.00
1	0	1	0	133.33
1	0	1	1	166.67
1	1	0	0	200.00
1	1	0	1	266.66
1	1	1	0	333.33
1	1	1	1	400.00

Notes:

Pins preceded by * have 120 Kohm pull UP resistors

Pins preceded by ** have 120 Kohm pull DOWN resistors

FS(2:0) and SEL14M_25M# are latched inputs

Power Groups

Pin Number		Description
VDD	GND	
3	4	REFOUT, Digital Inputs, SMBus
10	6	PCI Outputs
14,19,31,36,40	15,35	DIF Outputs
N/A	47	IREF
48	47	Analog VDD & GND for PLL Core

Pin Description

PIN #	PIN NAME	PIN TYPE	DESCRIPTION
1	XIN/CLKIN	IN	Crystal input or Reference Clock input
2	X2	OUT	Crystal output, Nominally 14.318MHz
3	VDD	PWR	Power supply, nominal 3.3V
4	GND	PWR	Ground pin.
5	FS2/REFOUT*	I/O	Frequency select latch input pin / Reference clock output
6	GND	PWR	Ground pin.
7	FS0/PCICLK_F*	I/O	Frequency select latch input pin / 3.3V PCI free running clock output.
8	PCICLK0	OUT	PCI clock output.
9	PCICLK1	OUT	PCI clock output.
10	VDD	PWR	Power supply, nominal 3.3V
11	OE_6**	IN	Active high input for enabling output 6. 0 = tri-state outputs, 1= enable outputs
12	DIF_6	OUT	0.7V differential true clock output
13	DIF_6#	OUT	0.7V differential complement clock output
14	VDD	PWR	Power supply, nominal 3.3V
15	GND	PWR	Ground pin.
16	OE_5**	IN	Active high input for enabling output 5. 0 = tri-state outputs, 1= enable outputs
17	DIF_5	OUT	0.7V differential true clock output
18	DIF_5#	OUT	0.7V differential complement clock output
19	VDD	PWR	Power supply, nominal 3.3V
20	DIF_4	OUT	0.7V differential true clock output
21	DIF_4#	OUT	0.7V differential complement clock output
22	OE_4*	IN	Active high input for enabling output 4. 0 = tri-state outputs, 1= enable outputs
23	SDATA	I/O	Data pin for SMBus circuitry, 3.3V tolerant.
24	SCLK	IN	Clock pin of SMBus circuitry, 5V tolerant.

Pin Description (Continued)

PIN #	PIN NAME	PIN TYPE	DESCRIPTION
25	DIF_STOP#	IN	Active low input to stop differential output clocks.
26	SPREAD*	IN	Asynchronous, active high input, with internal 120Kohm pull-up resistor, to enable spread spectrum functionality.
27	SEL14M_25M#**	IN	Select 14.31818 MHz or 25 Mhz input frequency. 1 = 14.31818 MHz, 0 = 25 MHz
28	OE_3*	IN	Active high input for enabling output 3. 0 = tri-state outputs, 1= enable outputs
29	DIF_3#	OUT	0.7V differential complement clock output
30	DIF_3	OUT	0.7V differential true clock output
31	VDD	PWR	Power supply, nominal 3.3V
32	DIF_2#	OUT	0.7V differential complement clock output
33	DIF_2	OUT	0.7V differential true clock output
34	OE_2**	IN	Active high input for enabling output 2. 0 = tri-state outputs, 1= enable outputs
35	GND	PWR	Ground pin.
36	VDD	PWR	Power supply, nominal 3.3V
37	OE_1**	IN	Active high input for enabling output 1. 0 = tri-state outputs, 1= enable outputs
38	DIF_1#	OUT	0.7V differential complement clock output
39	DIF_1	OUT	0.7V differential true clock output
40	VDD	PWR	Power supply, nominal 3.3V
41	DIF_0#	OUT	0.7V differential complement clock output
42	DIF_0	OUT	0.7V differential true clock output
43	OE_0*	IN	Active high input for enabling output 0. 0 = tri-state outputs, 1= enable outputs
44	FS1**	IN	3.3V Frequency select latched input pin.
45	DWNSPRD#*	IN	3.3V input that selects spread mode. This input is not latched at power up. 0 = Down Spread, 1 = Center Spread
46	IREF	OUT	This pin establishes the reference current for the differential current-mode output pairs. This pin requires a fixed precision resistor tied to ground in order to establish the appropriate current. 475 ohms is the standard value.
47	GNDA	PWR	Ground pin for the PLL core.
48	VDDA	PWR	3.3V power for the PLL core.

Pins preceded by * have 120 Kohm pull UP resistors

Pins preceded by ** have 120 Kohm pull DOWN resistors

General SMBus serial interface information for the ICS9FG107

How to Write:

- Controller (host) sends a start bit.
- Controller (host) sends the write address $DC_{(H)}$
- ICS clock will **acknowledge**
- Controller (host) sends the beginning byte location = N
- ICS clock will **acknowledge**
- Controller (host) sends the data byte count = X
- ICS clock will **acknowledge**
- Controller (host) starts sending **Byte N through Byte N + X - 1**
 (see Note 2)
- ICS clock will **acknowledge** each byte **one at a time**
- Controller (host) sends a Stop bit

How to Read:

- Controller (host) will send start bit.
- Controller (host) sends the write address $DC_{(H)}$
- ICS clock will **acknowledge**
- Controller (host) sends the beginning byte location = N
- ICS clock will **acknowledge**
- Controller (host) will send a separate start bit.
- Controller (host) sends the read address $DD_{(H)}$
- ICS clock will **acknowledge**
- ICS clock will send the data byte count = X
- ICS clock sends **Byte N + X - 1**
- ICS clock sends **Byte 0 through byte X (if $X_{(H)}$ was written to byte 8).**
- Controller (host) will need to acknowledge each byte
- Controller (host) will send a not acknowledge bit
- Controller (host) will send a stop bit

Index Block Write Operation		
Controller (Host)		ICS (Slave/Receiver)
T	starT bit	
Slave Address $DC_{(H)}$		
WR	WRite	
		ACK
Beginning Byte = N		
		ACK
Data Byte Count = X		
		ACK
Beginning Byte N		X Byte
○		
○		
○		
Byte N + X - 1		
		ACK
P	stoP bit	

Index Block Read Operation		
Controller (Host)		ICS (Slave/Receiver)
T	starT bit	
Slave Address $DC_{(H)}$		
WR	WRite	
		ACK
Beginning Byte = N		
		ACK
RT	Repeat starT	
Slave Address $DD_{(H)}$		
RD	ReaD	
		ACK
		Data Byte Count = X
ACK		
ACK		X Byte
○		
○		
○		
		Byte N + X - 1
N	Not acknowledge	
P	stoP bit	

I²C Table: Device Control Register, READ/WRITE ADDRESS (DC/DD)

Byte 0	Pin #	Name	Control Function	Type	0	1	PWD
Bit 7	27		FS3 ¹	RW	See Frequency Selection Table, Page 1		Pin 27
Bit 6	5		FS2 ¹	RW			Pin 5
Bit 5	44		FS1 ¹	RW			Pin 44
Bit 4	7		FS0 ¹	RW			Pin 7
Bit 3	26		Spread Enable ¹	RW	Off	On	Pin 26
Bit 2	-	Enable Software Control of Frequency, Spread Enable and Spread Type		RW	Hardware Select	Software Select	0
Bit 1		DIF_STOP# drive mode		RW	Driven	Hi-Z	0
Bit 0	45	DWNSPRD# ¹		RW	Down	Center	Pin 45

Notes:

1. These bits reflect the latched state of the corresponding pins at power up, but may be written to if Byte 0, bit 2 is set to '1'. FS3 is the SEL14M_25M# pin.

I²C Table: Output Enable Register

Byte 1	Pin #	Name	Control Function	Type	0	1	PWD
Bit 7	8	PCICLK0	Output Enable	RW	Stop Low	Enable	1
Bit 6	12,13	DIF_6	Output Enable	RW	Disable	Enable	1
Bit 5	17,18	DIF_5	Output Enable	RW	Disable	Enable	1
Bit 4	20,21	DIF_4	Output Enable	RW	Disable	Enable	1
Bit 3	30,29	DIF_3	Output Enable	RW	Disable	Enable	1
Bit 2	33,32	DIF_2	Output Enable	RW	Disable	Enable	1
Bit 1	39,38	DIF_1	Output Enable	RW	Disable	Enable	1
Bit 0	42,41	DIF_0	Output Enable	RW	Disable	Enable	1

I²C Table: Output Stop Mode Register

Byte 2	Pin #	Name	Control Function	Type	0	1	PWD
Bit 7	9	PCICLK1	Output Enable	RW	Stop Low	Enable	1
Bit 6	12,13	DIF_6	Stop Mode	RW	Free-run	Stop-able	0
Bit 5	17,18	DIF_5	Stop Mode	RW	Free-run	Stop-able	0
Bit 4	20,21	DIF_4	Stop Mode	RW	Free-run	Stop-able	0
Bit 3	30,29	DIF_3	Stop Mode	RW	Free-run	Stop-able	0
Bit 2	33,32	DIF_2	Stop Mode	RW	Free-run	Stop-able	0
Bit 1	39,38	DIF_1	Stop Mode	RW	Free-run	Stop-able	0
Bit 0	42,41	DIF_0	Stop Mode	RW	Free-run	Stop-able	0

I²C Table: Frequency Select Readback Register

Byte 3	Pin #	Name	Control Function	Type	0	1	PWD
Bit 7	27	SEL14M_25M# ¹ (FS3)	State of pin 27	R	See Frequency Selection Table, Page 1		Pin 27
Bit 6	5	FS2 ¹	State of pin 6	R			Pin 5
Bit 5	44	FS1 ¹	State of pin 44	R			Pin 44
Bit 4	7	FS0 ¹	State of pin 7	R			Pin 7
Bit 3	26	SPREAD ¹	State of pin 26	R	Off	On	Pin 26
Bit 2		RESERVED		R	RESERVED		X
Bit 1		RESERVED		R	RESERVED		X
Bit 0	45	DWNSPRD ¹	State of pin 45	R	Down	Center	Pin 45

Notes:

1. These read-only bits always reflect the latched state of the corresponding pins at power up.

I²C Table: Vendor & Revision ID Register

Byte 4	Pin #	Name	Control Function	Type	0	1	PWD
Bit 7	-	RID3	REVISION ID	R	-	-	0
Bit 6	-	RID2		R	-	-	0
Bit 5	-	RID1		R	-	-	0
Bit 4	-	RID0		R	-	-	0
Bit 3	-	VID3	VENDOR ID	R	-	-	0
Bit 2	-	VID2		R	-	-	0
Bit 1	-	VID1		R	-	-	0
Bit 0	-	VID0		R	-	-	1

I²C Table: DEVICE ID

Byte 5	Pin #	Name	Control Function	Type	0	1	PWD
Bit 7	-	Device ID = 07 Hex Bit 7 is MSB		R	RESERVED		0
Bit 6	-			R	RESERVED		0
Bit 5	-			R	RESERVED		0
Bit 4	-			R	RESERVED		0
Bit 3	-			R	RESERVED		0
Bit 2	-			R	RESERVED		1
Bit 1	-			R	RESERVED		1
Bit 0	-			R	RESERVED		1

I²C Table: Byte Count Register

Byte 6	Pin #	Name	Control Function	Type	0	1	PWD
Bit 7	-	BC7	Writing to this register will configure how many bytes will be read back, default is 07 = 7 bytes.	RW	-	-	0
Bit 6	-	BC6		RW	-	-	0
Bit 5	-	BC5		RW	-	-	0
Bit 4	-	BC4		RW	-	-	0
Bit 3	-	BC3		RW	-	-	0
Bit 2	-	BC2		RW	-	-	1
Bit 1	-	BC1		RW	-	-	1
Bit 0	-	BC0		RW	-	-	1

DIF_STOP# - Assertion (transition from '1' to '0')

Asserting DIF_STOP# pin stops all DIF outputs that are set to be stoppable after their next transition. When the SMBus DIF_STOP tri-state bit corresponding to the DIF output of interest is programmed to a '0', DIF output will stop DIF_True = HIGH and DIF_Complement = LOW. When the SMBus DIF_STOP tri-state bit corresponding to the DIF output of interest is programmed to a '1', DIF outputs will be tri-stated.

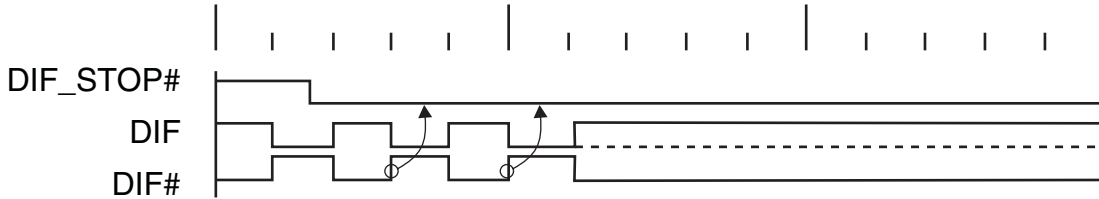

DIF_STOP# - De-assertion (transition from '0' to '1')

With the de-assertion of DIF_STOP# all stopped DIF outputs will resume without a glitch. The maximum latency from the de-assertion to active outputs is 2 - 6 DIF clock periods. If the control register tristate bit corresponding to the output of interest is programmed to '1', then the stopped DIF outputs will be driven High within 15nS of DIF_Stop# de-assertion to a voltage greater than 200mV.

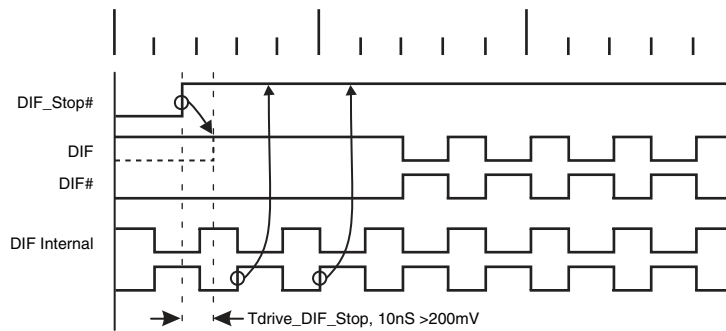

Absolute Max

Symbol	Parameter	Min	Max	Units
VDD_A	3.3V Core Supply Voltage		V _{DD} + 0.5V	V
VDD_In	3.3V Logic Input Supply Voltage	GND - 0.5	V _{DD} + 0.5V	V
Ts	Storage Temperature	-65	150	°C
Tambient	Ambient Operating Temp	0	70	°C
Tcase	Case Temperature		115	°C
ESD_prot	Input ESD protection human body model	2000		V

Electrical Characteristics - Input/Supply/Common Output ParametersT_A = 0 - 70°C; Supply Voltage V_{DD} = 3.3 V +/-5%

PARAMETER	SYMBOL	CONDITIONS	MIN	TYP	MAX	UNITS	NOTES
Input High Voltage	V _{IH}	3.3 V +/-5%	2		V _{DD} + 0.3	V	
Input Low Voltage	V _{IL}	3.3 V +/-5%	V _{SS} - 0.3		0.8	V	
Input High Current	I _{IH}	V _{IN} = V _{DD}	-5		5	uA	
Input Low Current	I _{IL1}	V _{IN} = 0 V; Inputs with no pull-up resistors	-5			uA	
	I _{IL2}	V _{IN} = 0 V; Inputs with pull-up resistors	-200			uA	
Operating Supply Current	I _{DD3.3OP}	Full Active, C _L = Full load; f = 400 MHz			250	mA	
		Full Active, C _L = Full load; f = 100 MHz			200	mA	
Input Frequency ³	F _i	V _{DD} = 3.3 V	14		25	MHz	3
Pin Inductance ¹	L _{pin}				7	nH	1
Input/Output Capacitance ¹	C _{IN}	Logic Inputs	1.5		5	pF	1
	C _{OUT}	Output pin capacitance			6	pF	1
Clk Stabilization ^{1,2}	T _{STAB}	From V _{DD} Power-Up and after input clock stabilization to 1st clock			1.8	ms	1,2
Modulation Frequency	f _{MOD}	Triangular Modulation	30		40	kHz	1
DIF output enable	t _{DIFOE}	DIF output enable after DIF_Stop# de-assertion			10	ns	1
Input Rise and Fall times	t _R /t _F	20% to 80% of VDD			5	ns	1

¹Guaranteed by design and characterization, not 100% tested in production.²See timing diagrams for timing requirements.³Input frequency should be measured at the REFOUT pin and tuned to ideal 14.31818MHz or 25 MHz to meet ppm frequency accuracy on PLL outputs.

Electrical Characteristics - DIF 0.7V Current Mode Differential Pair

T_A = 0 - 70°C; V_{DD} = 3.3 V +/-5%; C_L =2pF, R_S=33.2Ω, R_P=49.9Ω, I_{REF} = 475Ω

PARAMETER	SYMBOL	CONDITIONS	MIN	TYP	MAX	UNITS	NOTES
Current Source Output Impedance	Zo ¹	V _O = V _x	3000			Ω	1
Voltage High	VHigh	Statistical measurement on single ended signal using oscilloscope math function.	660		850	mV	1
Voltage Low	VLow		-150		150		1
Max Voltage	Vovs	Measurement on single ended signal using absolute value.			1150	mV	1
Min Voltage	Vuds		-300				1
Crossing Voltage (abs)	Vcross(abs)		250		550	mV	1
Crossing Voltage (var)	d-Vcross	Variation of crossing over all edges			140	mV	1
Long Accuracy	ppm	see Tperiod min-max values	-300		300	ppm	1,2
Average period	Tperiod	400MHz nominal	2.4993		2.5008	ns	2
		400MHz spread	2.4993		2.5133	ns	2,3
		333.33MHz nominal	2.9991		3.0009	ns	2
		333.33MHz spread	2.9991		3.016	ns	2,3
		266.66MHz nominal	3.7489		3.7511	ns	2
		266.66MHz spread	3.7489		3.77	ns	2,3
		200MHz nominal	4.9985		5.0015	ns	2
		200MHz spread	4.9985		5.0266	ns	2,3
		166.66MHz nominal	5.9982		6.0018	ns	2
		166.66MHz spread	5.9982		6.0320	ns	2,3
		133.33MHz nominal	7.4978		7.5023	ns	2
		133.33MHz spread	7.4978		7.5023	ns	2,3
Absolute min period	T _{absmin}	100.00MHz nominal	9.9970		10.0030	ns	2
		100.00MHz spread	9.9970		10.0533	ns	2,3
		400MHz nominal/spread	2.4143			ns	1,2
		333.33MHz nominal/spread	2.9141			ns	1,2
		266.66MHz nominal/spread	3.6639			ns	1,2
		200MHz nominal/spread	4.8735			ns	1,2
Rise Time	t _r	166.66MHz nominal/spread	5.8732			ns	1,2
		133.33MHz nominal/spread	7.3728			ns	1,2
		100.00MHz nominal/spread	9.8720			ns	1,2
Rise Time Variation	d-t _r			125	ps	1	
Fall Time	t _f	V _{OL} = 0.175V, V _{OH} = 0.525V	175		700	ps	1
Fall Time Variation	d-t _f	V _{OH} = 0.525V V _{OL} = 0.175V			125	ps	1
Duty Cycle	d ₁₃	Measurement from differential waveform	45		55	%	1
Jitter, Cycle to cycle	t _{jcc-cyc}	Measurement from differential waveform f not equal 266 MHz			50	ps	1
		Measurement from differential waveform f = 266 MHz			85	ps	1

¹Guaranteed by design and characterization, not 100% tested in production.

²All Long Term Accuracy and Clock Period specifications are guaranteed assuming that REFOUT is at 14.31818MHz or 25 MHz

³Figures are for down spread.

Output-Output Skew (DIFF0 as REFERENCE)	Min	Mean	Max	NOTES
Window Skew	73	54	35	1
Skew (ps)	Min	Mean	Max	
Dif0:1	-52	-28	-7	1
Dif0:2	-48	-25	-4	1
Dif0:3	-46	-25	-5	1
Dif0:4	-52	-26	-5	1
Dif0:5	-73	-52	-32	1
Dif0:6	-72	-54	-35	1

¹Guaranteed by design and characterization, not 100% tested in production.

Output-Output Skew (DIFF3 as REFERENCE)	Min	Mean	Max	NOTES
Window Skew	52	53	52	1
Skew (ps)	Min	Mean	Max	
Dif3:0	2	23	43	1
Dif3:1	-25	-5	18	1
Dif3:2	-24	-2	19	1
Dif3:4	-22	-2	21	1
Dif3:5	-50	-29	-9	1
Dif3:6	-49	-30	-6	1

¹Guaranteed by design and characterization, not 100% tested in production.

Electrical Characteristics - PCICLK/PCICLK_FT_A = 0 - 70°C; V_{DD} = 3.3 V +/-5%; C_L = 30 pF (unless otherwise specified)

PARAMETER	SYMBOL	CONDITIONS	MIN	TYP	MAX	UNITS	Notes
Long Accuracy	ppm	see Tperiod min-max values	-300		300	ppm	1,2
Clock period	T _{period}	33.33MHz output nominal	29.99100		30.00900	ns	2
		33.33MHz output spread	29.99100		30.15980	ns	2
Absolute Min/Max Clock period	T _{abs}	33.33MHz output nominal	29.49100		30.50900	ns	2
		33.33MHz output spread	29.49100		30.65980	ns	2
Clk High Time	t _{h1}		12		N/A	ns	1
Clock Low Time	t _{l1}		12		N/A	ns	1
Output High Voltage	V _{OH}	I _{OH} = -1 mA	2.4			V	
Output Low Voltage	V _{OL}	I _{OL} = 1 mA			0.55	V	
Output High Current	I _{OH}	V _{OH} @ MIN = 1.0 V	-33			mA	
		V _{OH} @ MAX = 3.135 V			-33	mA	
Output Low Current	I _{OL}	V _{OL} @ MIN = 1.95 V	30			mA	
		V _{OL} @ MAX = 0.4 V			38	mA	
Edge Rate		Rising edge rate	1		4	V/ns	1
Edge Rate		Falling edge rate	1		4	V/ns	1
Rise Time	t _{r1}	V _{OL} = 0.4 V, V _{OH} = 2.4 V	0.5	1.4	2	ns	1
Fall Time	t _{f1}	V _{OH} = 2.4 V, V _{OL} = 0.4 V	0.5	1.4	2	ns	1
Duty Cycle	d _{t1}	V _T = 1.5 V	45		55	%	1
Skew	t _{sk1}	V _T = 1.5 V			500	ps	1
Jitter	t _{jvc-cyc}	V _T = 1.5 V			250	ps	1

¹Guaranteed by design, not 100% tested in production.²All Long Term Accuracy and Clock Period specifications are guaranteed assuming that REFOUT is at 14.31818MHz or 25 MHz**Electrical Characteristics - REF-14.318/25 MHz**T_A = 0 - 70°C; V_{DD} = 3.3 V +/-5%; C_L = 10-20 pF (unless otherwise specified)

PARAMETER	SYMBOL	CONDITIONS	MIN	TYP	MAX	UNITS	Notes
Long Accuracy	ppm	see Tperiod min-max values	-300	0	300	ppm	1
Clock period	T _{period}	14.318MHz output nominal	69.8270	69.8413	69.8550	ns	1,2
		25.000MHz output nominal	39.9880	40.0000	40.0120	ns	1,2
Output High Voltage	V _{OH}	I _{OH} = -1 mA	2.4			V	1
Output Low Voltage	V _{OL}	I _{OL} = 1 mA			0.4	V	1
Output High Current	I _{OH}	V _{OH} @ MIN = 1.0 V, V _{OH} @ MAX = 3.135 V	-29		-23	mA	1
Output Low Current	I _{OL}	V _{OL} @ MIN = 1.95 V, V _{OL} @ MAX = 0.4 V	29		27	mA	1
Rise Time	t _{r1}	V _{OL} = 0.4 V, V _{OH} = 2.4 V	1	1.6	2	ns	1
Fall Time	t _{f1}	V _{OH} = 2.4 V, V _{OL} = 0.4 V	1	1.6	2	ns	1
Duty Cycle	d _{t1}	V _T = 1.5 V	45		55	%	1
Jitter	t _{jvc-cyc}	V _T = 1.5 V		160	250	ps	1

¹Guaranteed by design and characterization, not 100% tested in production.²All Long Term Accuracy and Clock Period specifications are guaranteed assuming that REFOUT is at 14.31818 or 25.00 MHz

SRC Reference Clock			
Common Recommendations for Differential Routing	Dimension or Value	Unit	Figure
L1 length, Route as non-coupled 50 ohm trace.	0.5 max	inch	1
L2 length, Route as non-coupled 50 ohm trace.	0.2 max	inch	1
L3 length, Route as non-coupled 50 ohm trace.	0.2 max	inch	1
Rs	33	ohm	1
Rt	49.9	ohm	1

Down Device Differential Routing	Dimension or Value	Unit	Figure
L4 length, Route as coupled microstrip 100 ohm differential trace.	2 min to 16 max	inch	1
L4 length, Route as coupled stripline 100 ohm differential trace.	1.8 min to 14.4 max	inch	1

Differential Routing to PCI Express Connector	Dimension or Value	Unit	Figure
L4 length, Route as coupled microstrip 100 ohm differential trace.	0.25 to 14 max	inch	2
L4 length, Route as coupled stripline 100 ohm differential trace.	0.225 min to 12.6 max	inch	2

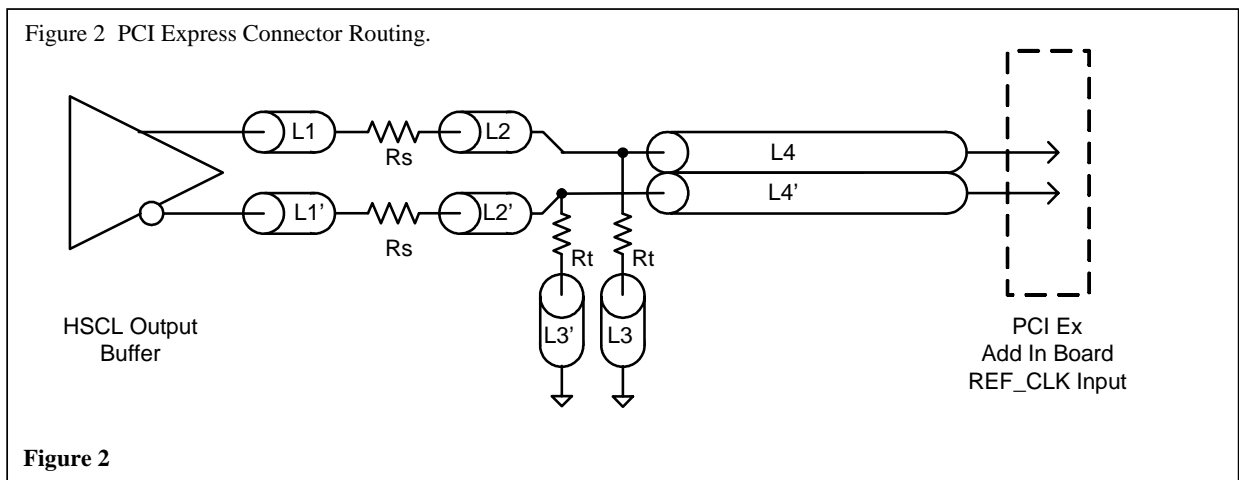
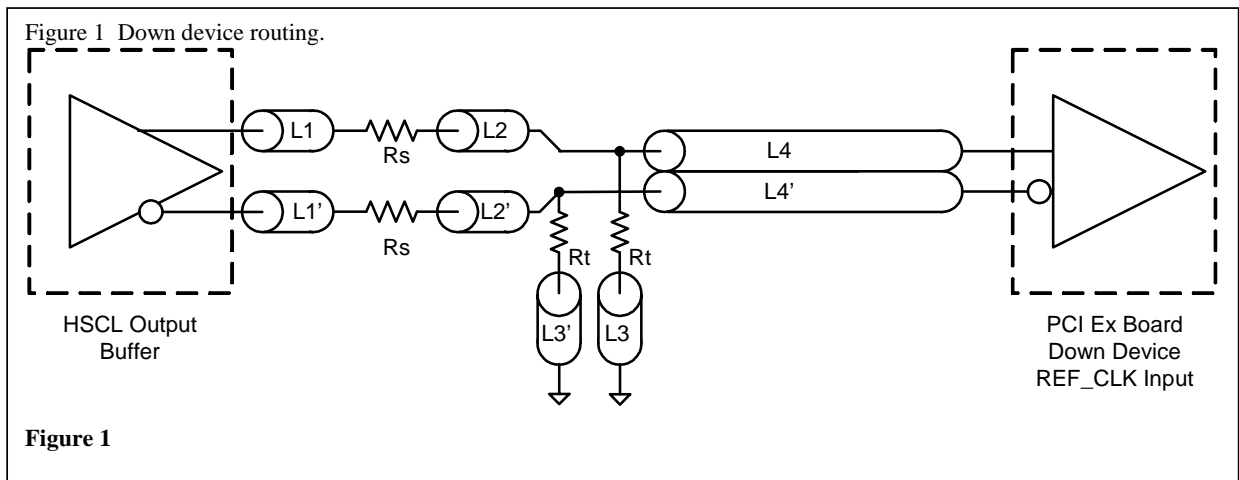

Alternative termination for LVDS and other common differential signals. Figure 3.

Vdiff	Vp-p	Vcm	R1	R2	R3	R4	Note
0.45 v	0.22v	1.08	33	150	100	100	
0.58	0.28	0.6	33	78.7	137	100	
0.80	0.40	0.6	33	78.7	none	100	ICS874003i-02 input compatible
0.60	0.3	1.2	33	174	140	100	Standard LVDS

R1a = R1b = R1

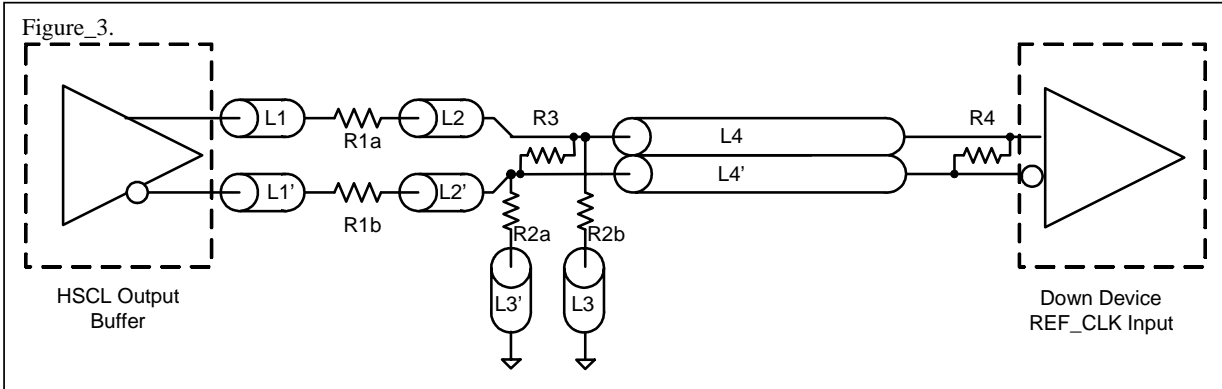

R2a = R2b = R2

Cable connected AC coupled application, figure 4

Component	Value	Note
R5a,R5b	8.2K 5%	
R6a,R6b	1K 5%	
Cc	0.1 uF	
Vcm	0.350 volts	

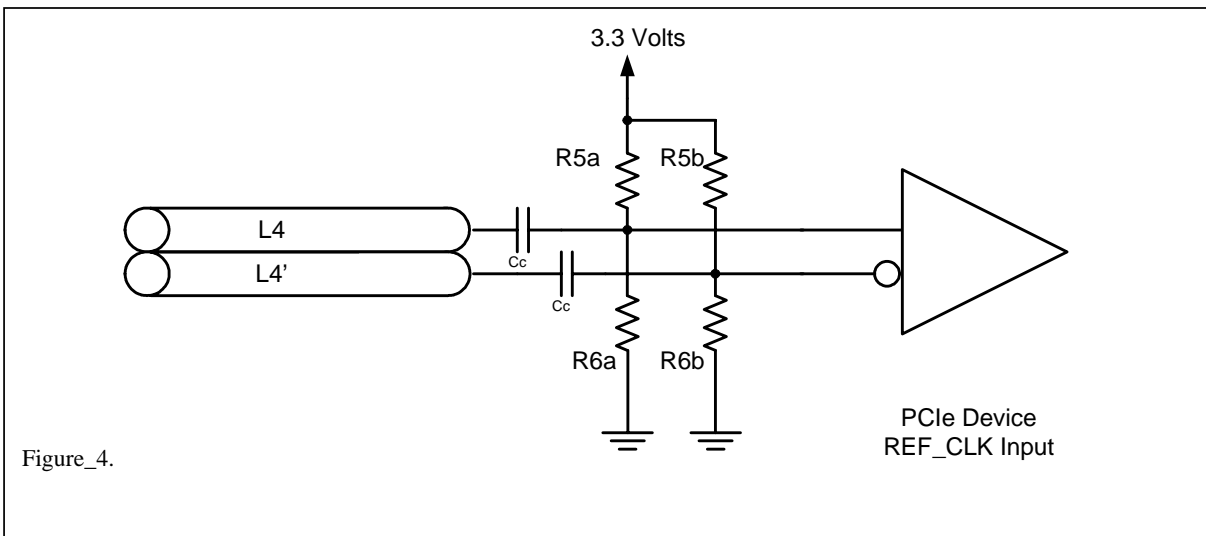

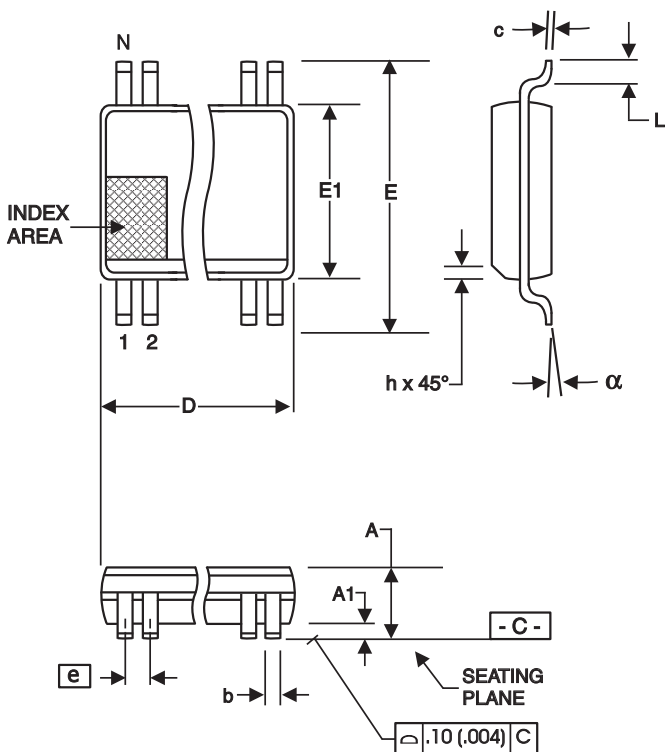

SYMBOL	In Millimeters		In Inches	
	COMMON DIMENSIONS		COMMON DIMENSIONS	
	MIN	MAX	MIN	MAX
A	2.41	2.80	.095	.110
A1	0.20	0.40	.008	.016
b	0.20	0.34	.008	.0135
c	0.13	0.25	.005	.010
D	SEE VARIATIONS		SEE VARIATIONS	
E	10.03	10.68	.395	.420
E1	7.40	7.60	.291	.299
e	0.635 BASIC		0.025 BASIC	
h	0.38	0.64	.015	.025
L	0.50	1.02	.020	.040
N	SEE VARIATIONS		SEE VARIATIONS	
†	0°	8°	0°	8°

VARIATIONS

N	D mm.		D (inch)	
	MIN	MAX	MIN	MAX
48	15.75	16.00	.620	.630

Reference Doc.: JEDEC Publication 95, MO-118
 10-0034

Ordering Information

ICS 9FG107yFLFT

Example:

ICS XXXX y F Lx T

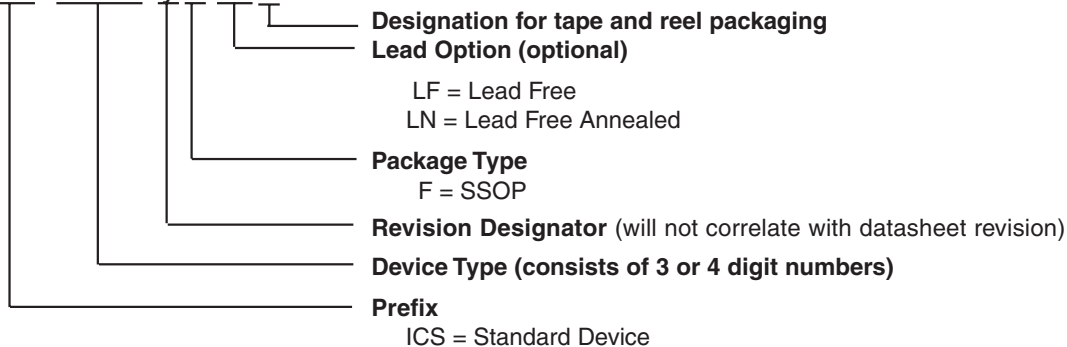

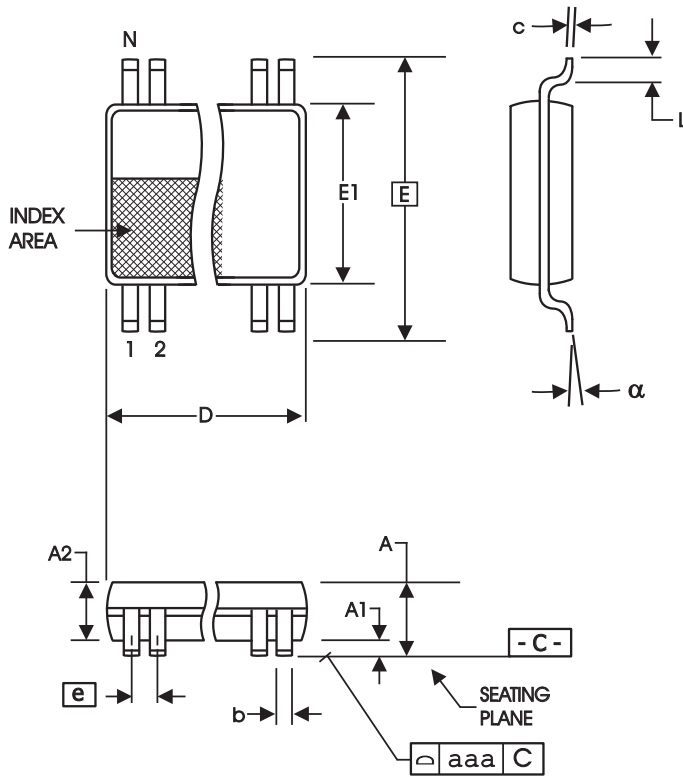

48-Lead, 6.10 mm. Body, 0.50 mm. Pitch TSSOP
 (240 mil) (20 mil)

SYMBOL	In Millimeters COMMON DIMENSIONS		In Inches COMMON DIMENSIONS	
	MIN	MAX	MIN	MAX
A	--	1.20	--	.047
A1	0.05	0.15	.002	.006
A2	0.80	1.05	.032	.041
b	0.17	0.27	.007	.011
c	0.09	0.20	.0035	.008
D	SEE VARIATIONS		SEE VARIATIONS	
E	8.10 BASIC		0.319 BASIC	
E1	6.00	6.20	.236	.244
e	0.50 BASIC		0.020 BASIC	
L	0.45	0.75	.018	.030
N	SEE VARIATIONS		SEE VARIATIONS	
a	0°	8°	0°	8°
aaa	--	0.10	--	.004

VARIATIONS

N	D mm.		D (inch)	
	MIN	MAX	MIN	MAX
48	12.40	12.60	.488	.496

Reference Doc.: JEDEC Publication 95, MO-153

10-0039

Ordering Information

ICS 9FG107yGLFT

Example:

ICS XXXX y G Lx T

Designation for tape and reel packaging
Lead Option (optional)

LF = Lead Free
 LN = Lead Free Annealed

Package Type
 G = TSSOP

Revision Designator (will not correlate with datasheet revision)

Device Type (consists of 3 or 4 digit numbers)

Prefix

ICS = Standard Device

Revision History

Rev.	Issue Date	Description	Page #
D	08/06/07	Updated Differential Output Skew Specifications	11
E	08/08/07	Updated Differential Output Skew Specifications	11
F	08/21/07	Updated Differential Output Skew Specifications	11

Innovate with IDT and accelerate your future networks. Contact:

www.IDT.com

For Sales

800-345-7015
408-284-8200
Fax: 408-284-2775

For Tech Support

408-284-6578
pcclockhelp@idt.com

Corporate Headquarters

Integrated Device Technology, Inc.
6024 Silver Creek Valley Road
San Jose, CA 95138
United States
800 345 7015
+408 284 8200 (outside U.S.)

Asia Pacific and Japan

Integrated Device Technology
Singapore (1997) Pte. Ltd.
Reg. No. 199707558G
435 Orchard Road
#20-03 Wisma Atria
Singapore 238877
+65 6 887 5505

Europe

IDT Europe, Limited
Prime House
Barnett Wood Lane
Leatherhead, Surrey
United Kingdom KT22 7DE
+44 1372 363 339



www.IDT.com