

### General Description

The AON6926 is designed to provide a high efficiency synchronous buck power stage with optimal layout and board space utilization. It includes two specialized MOSFETs in a dual Power DFN5x6A package. The Q1 "High Side" MOSFET is designed to minimize switching losses. The Q2 "Low Side" MOSFET is an SRFET™ that features low  $R_{DS(ON)}$  to reduce conduction losses as well as an integrated Schottky diode with low  $Q_{RR}$  and  $V_f$  to reduce switching losses. The AON6926 is well suited for use in compact DC/DC converter applications.

### Product Summary

	Q1	Q2
$V_{DS}$	30V	30V
$I_D$ (at $V_{GS}=10V$ )	44A	50A
$R_{DS(ON)}$ (at $V_{GS}=10V$ )	<11m $\Omega$	<8.5m $\Omega$
$R_{DS(ON)}$ (at $V_{GS} = 4.5V$ )	<14m $\Omega$	<12m $\Omega$

100% UIS Tested  
 100% Rg Tested

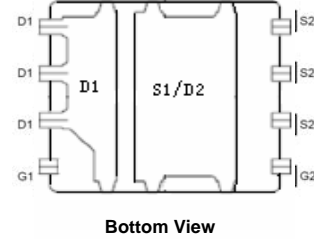
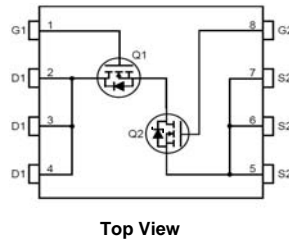
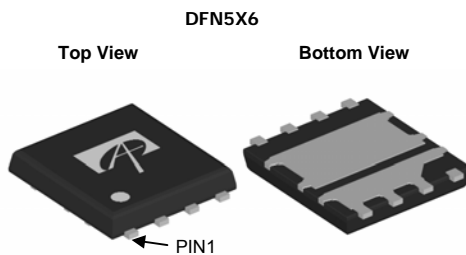

### Absolute Maximum Ratings $T_A=25^\circ C$ unless otherwise noted

Parameter	Symbol	Max Q1	Max Q2	Units	
Drain-Source Voltage	$V_{DS}$	30		V	
Gate-Source Voltage	$V_{GS}$	$\pm 20$	$\pm 20$	V	
Continuous Drain Current	$I_D$	$T_C=25^\circ C$	44	50	A
		$T_C=100^\circ C$	28	32	
Pulsed Drain Current <sup>C</sup>	$I_{DM}$	100	140		
Continuous Drain Current	$I_{DSM}$	$T_A=25^\circ C$	11	12	A
		$T_A=70^\circ C$	9	10	
Avalanche Current <sup>C</sup>	$I_{AS}, I_{AR}$	27	15	A	
Avalanche Energy $L=0.1mH$ <sup>C</sup>	$E_{AS}, E_{AR}$	36	11	mJ	
Power Dissipation <sup>B</sup>	$P_D$	$T_C=25^\circ C$	31	35	W
		$T_C=100^\circ C$	12.5	14	
Power Dissipation <sup>A</sup>	$P_{DSM}$	$T_A=25^\circ C$	1.9	2.1	W
		$T_A=70^\circ C$	1.2	1.3	
Junction and Storage Temperature Range	$T_J, T_{STG}$	-55 to 150		$^\circ C$	

### Thermal Characteristics

Parameter		Symbol	Typ Q1	Typ Q2	Max Q1	Max Q2	Units
Maximum Junction-to-Ambient <sup>A</sup>	$t \leq 10s$	$R_{\theta JA}$	29	24	35	29	$^\circ C/W$
Maximum Junction-to-Ambient <sup>A,D</sup>	Steady-State		56	50	67	60	$^\circ C/W$
Maximum Junction-to-Case	Steady-State	$R_{\theta JC}$	3.4	3	4	3.6	$^\circ C/W$

**Q1 Electrical Characteristics (T<sub>J</sub>=25°C unless otherwise noted)**

Symbol	Parameter	Conditions	Min	Typ	Max	Units
<b>STATIC PARAMETERS</b>						
BV <sub>DSS</sub>	Drain-Source Breakdown Voltage	I <sub>D</sub> =250μA, V <sub>GS</sub> =0V	30			V
I <sub>DSS</sub>	Zero Gate Voltage Drain Current	V <sub>DS</sub> =30V, V <sub>GS</sub> =0V T <sub>J</sub> =125°C			1 5	μA
I <sub>GSS</sub>	Gate-Body leakage current	V <sub>DS</sub> =0V, V <sub>GS</sub> = ±20V			100	nA
V <sub>GS(th)</sub>	Gate Threshold Voltage	V <sub>DS</sub> =V <sub>GS</sub> I <sub>D</sub> =250μA	1.5	2	2.5	V
I <sub>D(ON)</sub>	On state drain current	V <sub>GS</sub> =10V, V <sub>DS</sub> =5V	100			A
R <sub>DS(ON)</sub>	Static Drain-Source On-Resistance	V <sub>GS</sub> =10V, I <sub>D</sub> =20A T <sub>J</sub> =125°C		8.8 12	11 15	mΩ
		V <sub>GS</sub> =4.5V, I <sub>D</sub> =20A		11.2	14	mΩ
g <sub>FS</sub>	Forward Transconductance	V <sub>DS</sub> =5V, I <sub>D</sub> =20A		55		S
V <sub>SD</sub>	Diode Forward Voltage	I <sub>S</sub> =1A, V <sub>GS</sub> =0V		0.74	1	V
I <sub>S</sub>	Maximum Body-Diode Continuous Current				35	A
<b>DYNAMIC PARAMETERS</b>						
C <sub>iss</sub>	Input Capacitance	V <sub>GS</sub> =0V, V <sub>DS</sub> =15V, f=1MHz	920	1150	1380	pF
C <sub>oss</sub>	Output Capacitance		125	180	235	pF
C <sub>rss</sub>	Reverse Transfer Capacitance		60	105	150	pF
R <sub>g</sub>	Gate resistance	V <sub>GS</sub> =0V, V <sub>DS</sub> =0V, f=1MHz	0.55	1.1	1.65	Ω
<b>SWITCHING PARAMETERS</b>						
Q <sub>g</sub> (10V)	Total Gate Charge	V <sub>GS</sub> =10V, V <sub>DS</sub> =15V, I <sub>D</sub> =20A	16	20	24	nC
Q <sub>g</sub> (4.5V)	Total Gate Charge		7	9.5	11.4	nC
Q <sub>gs</sub>	Gate Source Charge			2.7		nC
Q <sub>gd</sub>	Gate Drain Charge			5		nC
t <sub>D(on)</sub>	Turn-On Delay Time	V <sub>GS</sub> =10V, V <sub>DS</sub> =15V, R <sub>L</sub> =0.75Ω, R <sub>GEN</sub> =3Ω		6.5		ns
t <sub>r</sub>	Turn-On Rise Time			2		ns
t <sub>D(off)</sub>	Turn-Off Delay Time			17		ns
t <sub>f</sub>	Turn-Off Fall Time			3.5		ns
t <sub>rr</sub>	Body Diode Reverse Recovery Time	I <sub>F</sub> =20A, dI/dt=500A/μs	7	8.7	10.5	ns
Q <sub>rr</sub>	Body Diode Reverse Recovery Charge	I <sub>F</sub> =20A, dI/dt=500A/μs	11	13.5	16	nC

A. The value of R<sub>θJA</sub> is measured with the device mounted on 1 in<sup>2</sup> FR-4 board with 2oz. Copper, in a still air environment with T<sub>A</sub>=25°C. The Power dissipation P<sub>DSM</sub> is based on R<sub>θJA</sub> and the maximum allowed junction temperature of 150°C. The value in any given application depends on the user's specific board design.

B. The power dissipation P<sub>D</sub> is based on T<sub>J(MAX)</sub>=150°C, using junction-to-case thermal resistance, and is more useful in setting the upper dissipation limit for cases where additional heatsinking is used.

C. Repetitive rating, pulse width limited by junction temperature T<sub>J(MAX)</sub>=150°C. Ratings are based on low frequency and duty cycles to keep initial T<sub>J</sub>=25°C.

D. The R<sub>θJA</sub> is the sum of the thermal impedance from junction to case R<sub>θJC</sub> and case to ambient.

E. The static characteristics in Figures 1 to 6 are obtained using <300 μs pulses, duty cycle 0.5% max.

F. These curves are based on the junction-to-case thermal impedance which is measured with the device mounted to a large heatsink, assuming a maximum junction temperature of T<sub>J(MAX)</sub>=150°C. The SOA curve provides a single pulse rating.

G. The maximum current rating is limited by package.

H. These tests are performed with the device mounted on 1 in<sup>2</sup> FR-4 board with 2oz. Copper, in a still air environment with T<sub>A</sub>=25°C.

COMPONENTS IN LIFE SUPPORT DEVICES OR SYSTEMS ARE NOT AUTHORIZED. AOS DOES NOT ASSUME ANY LIABILITY ARISING OUT OF SUCH APPLICATIONS OR USES OF ITS PRODUCTS. AOS RESERVES THE RIGHT TO IMPROVE PRODUCT DESIGN, FUNCTIONS AND RELIABILITY WITHOUT NOTICE.

**Q1-CHANNEL: TYPICAL ELECTRICAL AND THERMAL CHARACTERISTICS**

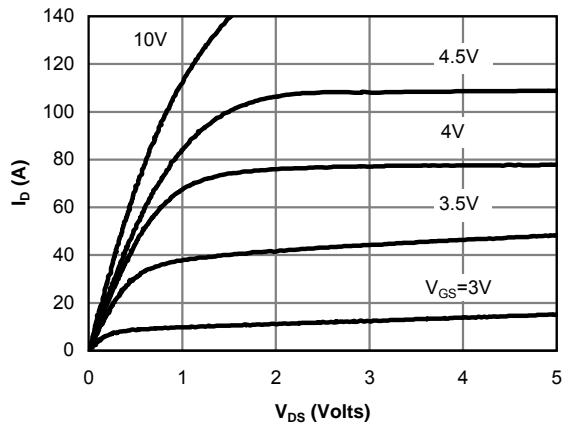

Fig 1: On-Region Characteristics (Note E)

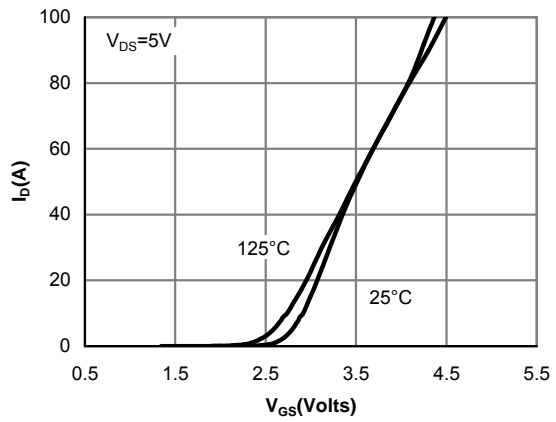

Figure 2: Transfer Characteristics (Note E)

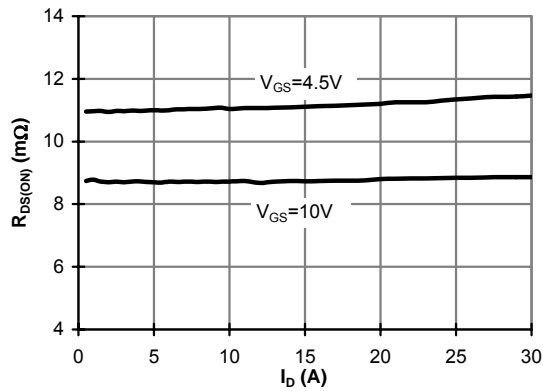

Figure 3: On-Resistance vs. Drain Current and Gate Voltage (Note E)

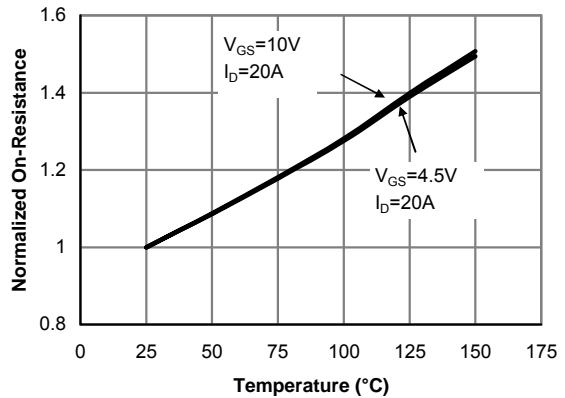

Figure 4: On-Resistance vs. Junction Temperature (Note E)

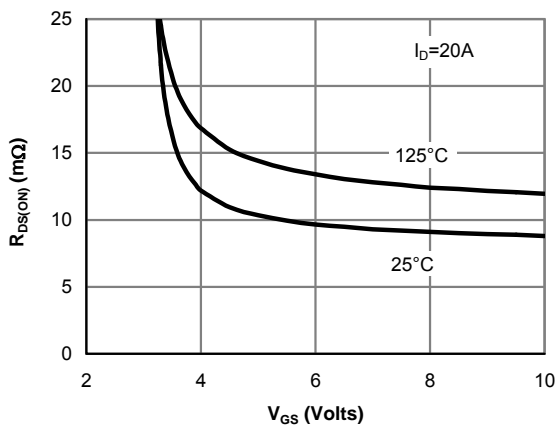

Figure 5: On-Resistance vs. Gate-Source Voltage (Note E)

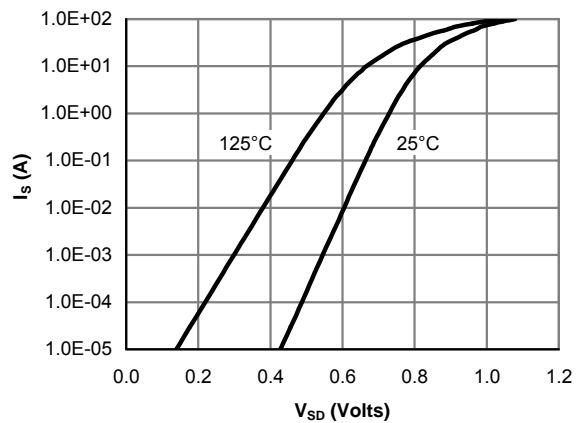

Figure 6: Body-Diode Characteristics (Note E)

**Q1-CHANNEL: TYPICAL ELECTRICAL AND THERMAL CHARACTERISTICS**

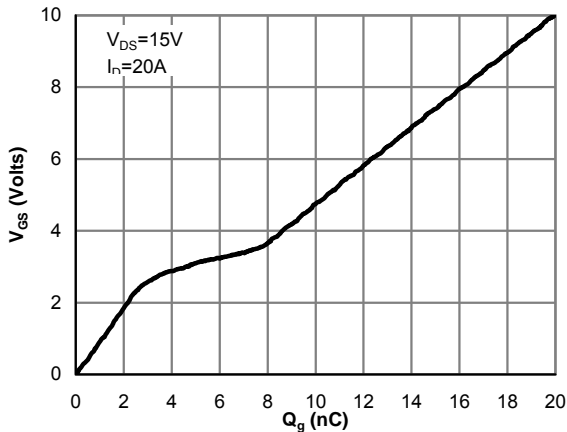

Figure 7: Gate-Charge Characteristics

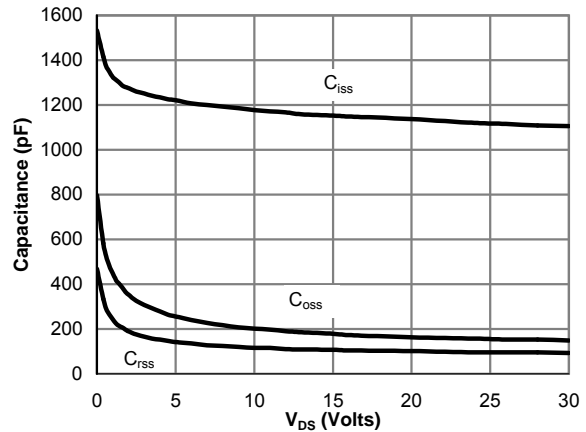

Figure 8: Capacitance Characteristics

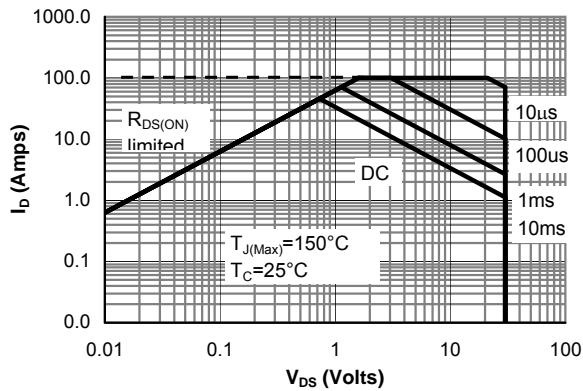

Figure 9: Maximum Forward Biased Safe Operating Area (Note F)

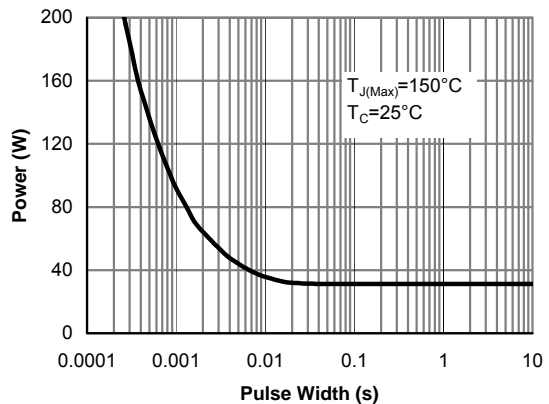

Figure 10: Single Pulse Power Rating Junction-to-Case (Note F)

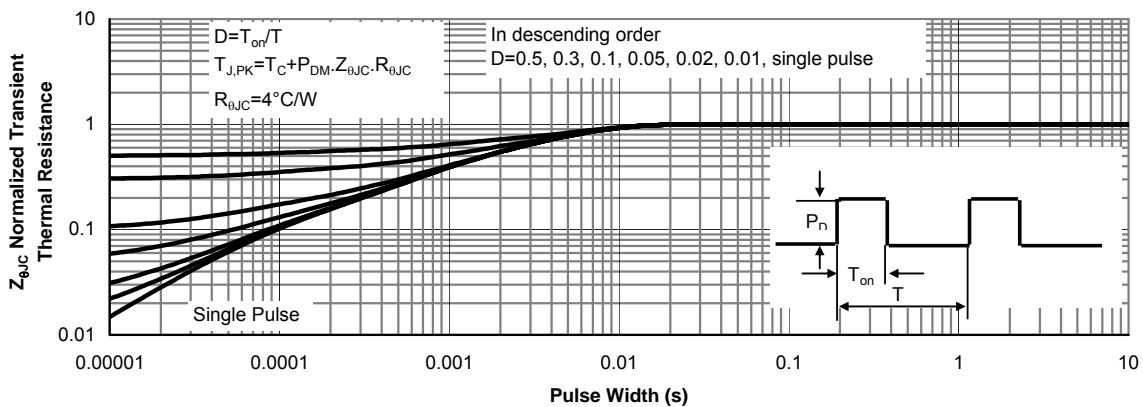
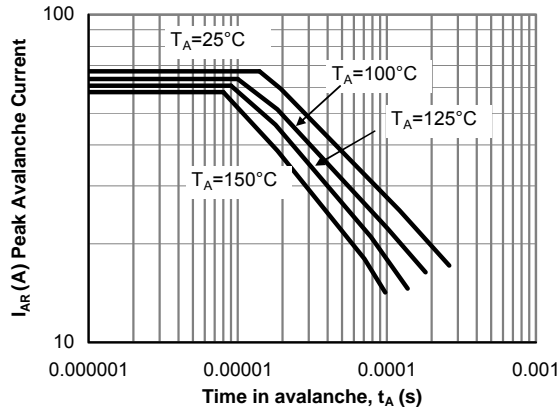
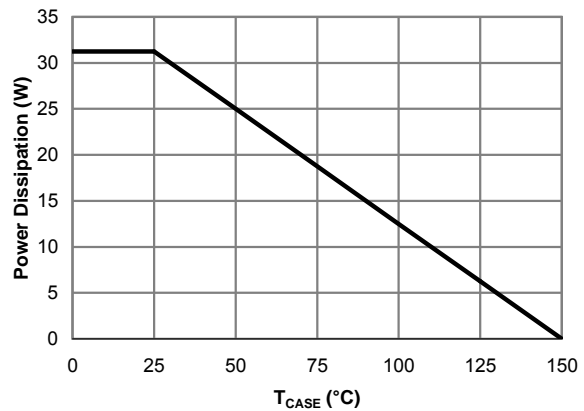

Figure 11: Normalized Maximum Transient Thermal Impedance (Note F)

**Q1-CHANNEL: TYPICAL ELECTRICAL AND THERMAL CHARACTERISTICS**



**Figure 12: Single Pulse Avalanche capability (Note C)**



**Figure 13: Power De-rating (Note F)**

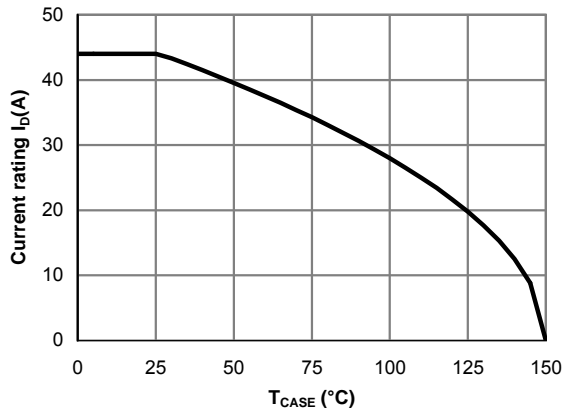

**Figure 14: Current De-rating (Note F)**

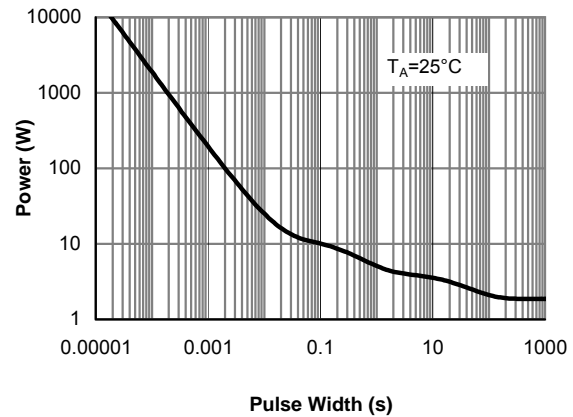

**Figure 15: Single Pulse Power Rating Junction-to-Ambient (Note H)**

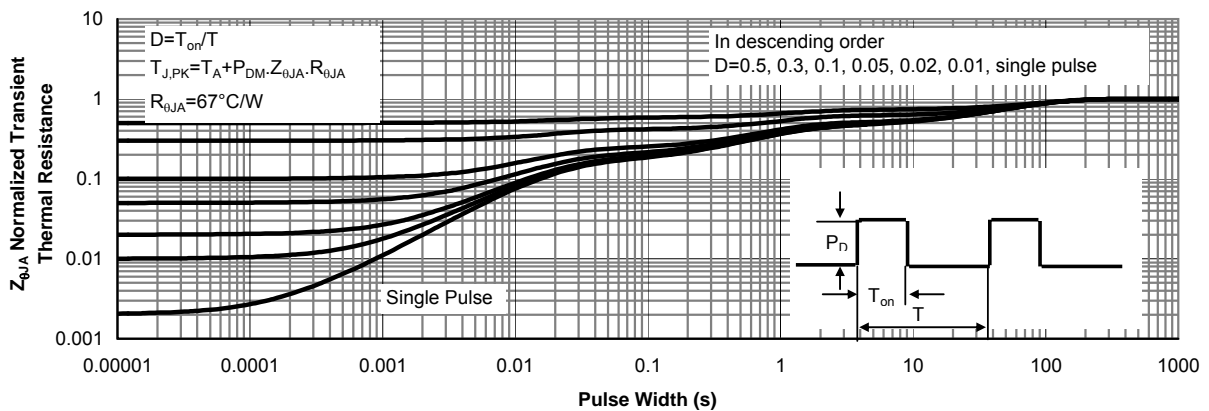

**Figure 16: Normalized Maximum Transient Thermal Impedance (Note H)**

**Q2 Electrical Characteristics (T<sub>J</sub>=25°C unless otherwise noted)**

Symbol	Parameter	Conditions	Min	Typ	Max	Units
<b>STATIC PARAMETERS</b>						
BV <sub>DSS</sub>	Drain-Source Breakdown Voltage	I <sub>D</sub> =250μA, V <sub>GS</sub> =0V	30			V
I <sub>DSS</sub>	Zero Gate Voltage Drain Current	V <sub>DS</sub> =30V, V <sub>GS</sub> =0V T <sub>J</sub> =125°C			0.5 100	mA
I <sub>GSS</sub>	Gate-Body leakage current	V <sub>DS</sub> =0V, V <sub>GS</sub> = ±20V			100	nA
V <sub>GS(th)</sub>	Gate Threshold Voltage	V <sub>DS</sub> =V <sub>GS</sub> I <sub>D</sub> =250μA	1.2	1.9	2.4	V
I <sub>D(ON)</sub>	On state drain current	V <sub>GS</sub> =10V, V <sub>DS</sub> =5V	140			A
R <sub>DS(ON)</sub>	Static Drain-Source On-Resistance	V <sub>GS</sub> =10V, I <sub>D</sub> =20A T <sub>J</sub> =125°C		6.9 9.8	8.5 12	mΩ
		V <sub>GS</sub> =4.5V, I <sub>D</sub> =20A		9.3	12	mΩ
g <sub>FS</sub>	Forward Transconductance	V <sub>DS</sub> =5V, I <sub>D</sub> =20A		50		S
V <sub>SD</sub>	Diode Forward Voltage	I <sub>S</sub> =1A, V <sub>GS</sub> =0V		0.5	0.7	V
I <sub>S</sub>	Maximum Body-Diode Continuous Current				40	A
<b>DYNAMIC PARAMETERS</b>						
C <sub>iss</sub>	Input Capacitance	V <sub>GS</sub> =0V, V <sub>DS</sub> =15V, f=1MHz	900	1130	1360	pF
C <sub>oss</sub>	Output Capacitance		320	465	605	pF
C <sub>rss</sub>	Reverse Transfer Capacitance		12	40	70	pF
R <sub>g</sub>	Gate resistance	V <sub>GS</sub> =0V, V <sub>DS</sub> =0V, f=1MHz	0.35	0.7	1.1	Ω
<b>SWITCHING PARAMETERS</b>						
Q <sub>g</sub> (10V)	Total Gate Charge	V <sub>GS</sub> =10V, V <sub>DS</sub> =15V, I <sub>D</sub> =20A	12	16	20	nC
Q <sub>g</sub> (4.5V)	Total Gate Charge		6	8	10	nC
Q <sub>gs</sub>	Gate Source Charge			3		nC
Q <sub>gd</sub>	Gate Drain Charge			3		nC
t <sub>D(on)</sub>	Turn-On Delay Time	V <sub>GS</sub> =10V, V <sub>DS</sub> =15V, R <sub>L</sub> =0.75Ω, R <sub>GEN</sub> =3Ω		6		ns
t <sub>r</sub>	Turn-On Rise Time			4		ns
t <sub>D(off)</sub>	Turn-Off Delay Time			19		ns
t <sub>f</sub>	Turn-Off Fall Time			3		ns
t <sub>rr</sub>	Body Diode Reverse Recovery Time	I <sub>F</sub> =20A, dI/dt=500A/μs	9	12	15	ns
Q <sub>rr</sub>	Body Diode Reverse Recovery Charge	I <sub>F</sub> =20A, dI/dt=500A/μs	18	23	28	nC

A. The value of R<sub>θJA</sub> is measured with the device mounted on 1 in<sup>2</sup> FR-4 board with 2oz. Copper, in a still air environment with T<sub>A</sub>=25°C. The Power dissipation P<sub>DSM</sub> is based on R<sub>θJA</sub> and the maximum allowed junction temperature of 150°C. The value in any given application depends on the user's specific board design.

B. The power dissipation P<sub>D</sub> is based on T<sub>J(MAX)</sub>=150°C, using junction-to-case thermal resistance, and is more useful in setting the upper dissipation limit for cases where additional heatsinking is used.

C. Repetitive rating, pulse width limited by junction temperature T<sub>J(MAX)</sub>=150°C. Ratings are based on low frequency and duty cycles to keep initial T<sub>J</sub>=25°C.

D. The R<sub>θJA</sub> is the sum of the thermal impedance from junction to case R<sub>θJC</sub> and case to ambient.

E. The static characteristics in Figures 1 to 6 are obtained using <300 μs pulses, duty cycle 0.5% max.

F. These curves are based on the junction-to-case thermal impedance which is measured with the device mounted to a large heatsink, assuming a maximum junction temperature of T<sub>J(MAX)</sub>=150°C. The SOA curve provides a single pulse rating.

G. These tests are performed with the device mounted on 1 in<sup>2</sup> FR-4 board with 2oz. Copper, in a still air environment with T<sub>A</sub>=25°C.

COMPONENTS IN LIFE SUPPORT DEVICES OR SYSTEMS ARE NOT AUTHORIZED. AOS DOES NOT ASSUME ANY LIABILITY ARISING OUT OF SUCH APPLICATIONS OR USES OF ITS PRODUCTS. AOS RESERVES THE RIGHT TO IMPROVE PRODUCT DESIGN, FUNCTIONS AND RELIABILITY WITHOUT NOTICE.

**Q2-CHANNEL: TYPICAL ELECTRICAL AND THERMAL CHARACTERISTICS**

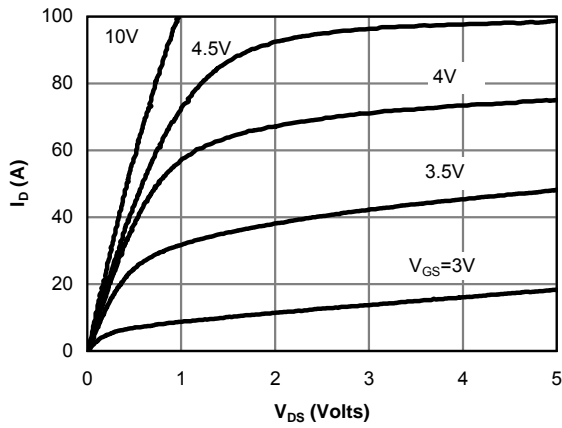

**Fig 1: On-Region Characteristics (Note E)**

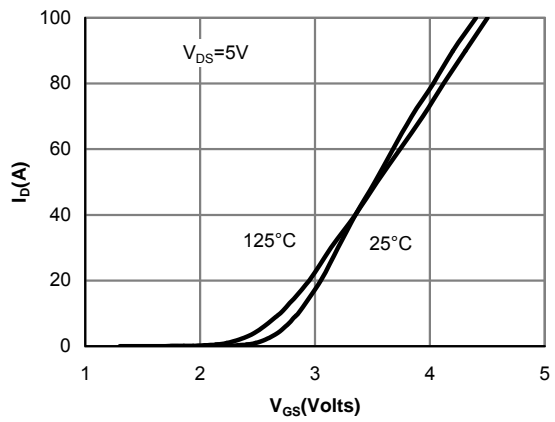

**Figure 2: Transfer Characteristics (Note E)**

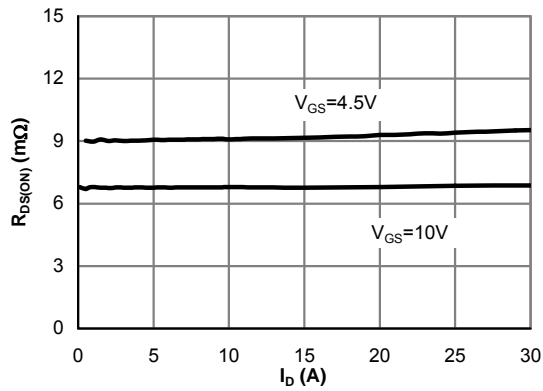

**Figure 3: On-Resistance vs. Drain Current and Gate Voltage (Note E)**

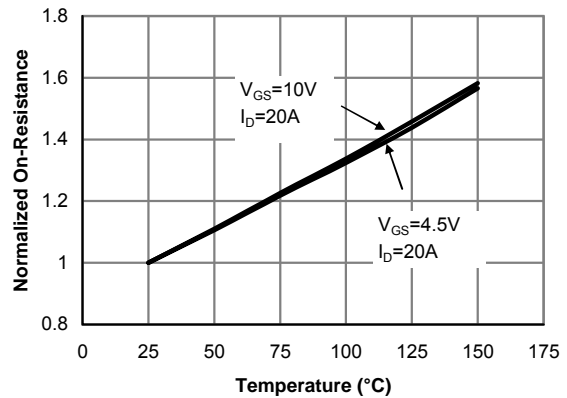

**Figure 4: On-Resistance vs. Junction Temperature (Note E)**

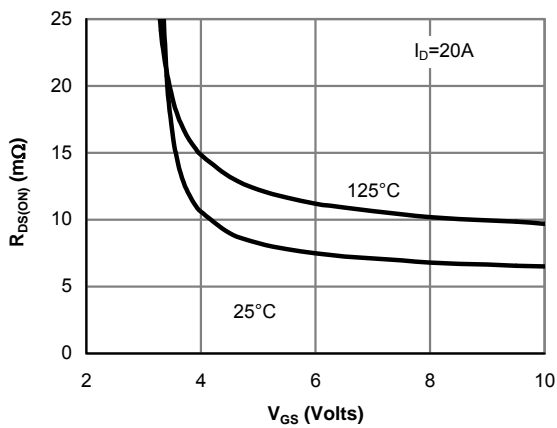

**Figure 5: On-Resistance vs. Gate-Source Voltage (Note E)**

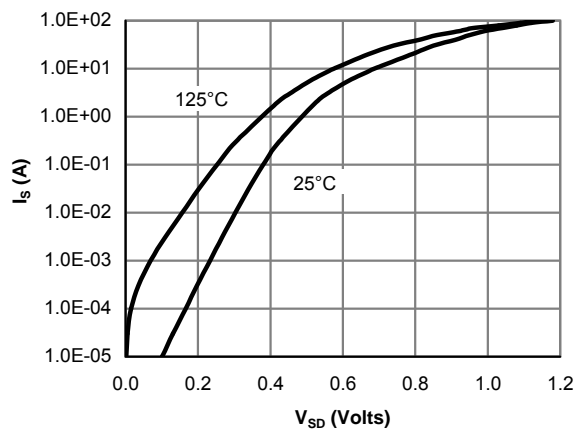

**Figure 6: Body-Diode Characteristics (Note E)**

**Q2-CHANNEL: TYPICAL ELECTRICAL AND THERMAL CHARACTERISTICS**

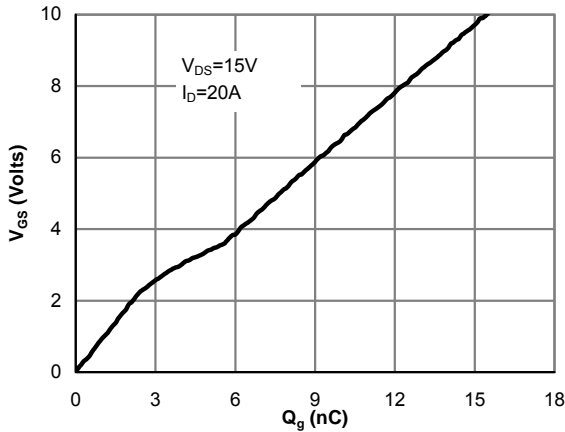

Figure 7: Gate-Charge Characteristics

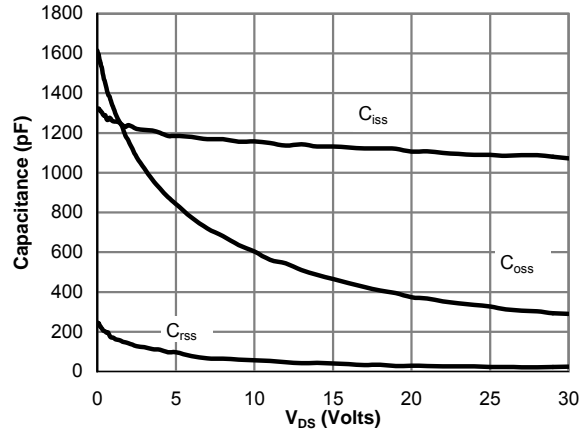

Figure 8: Capacitance Characteristics

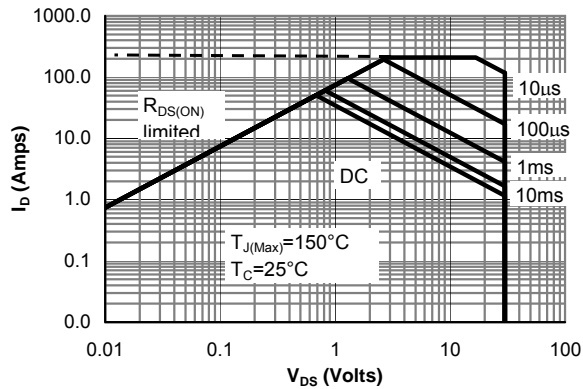

Figure 9: Maximum Forward Biased Safe Operating Area (Note F)

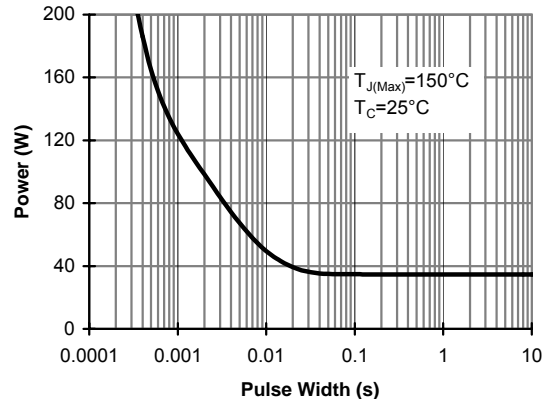

Figure 10: Single Pulse Power Rating Junction-to-Case (Note F)

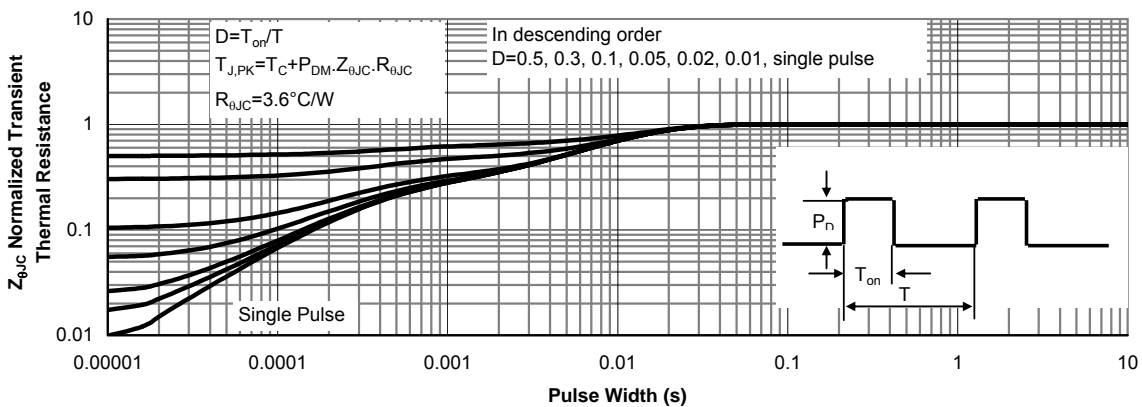

Figure 11: Normalized Maximum Transient Thermal Impedance (Note F)



**Q2-CHANNEL: TYPICAL ELECTRICAL AND THERMAL CHARACTERISTICS**

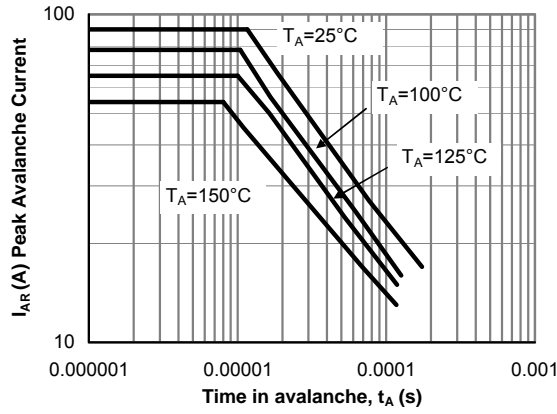

Figure 12: Single Pulse Avalanche capability (Note C)

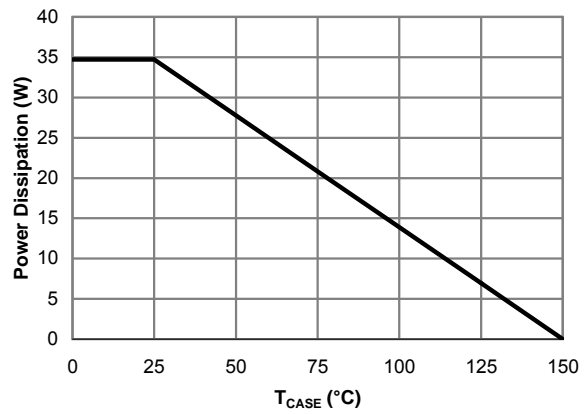

Figure 13: Power De-rating (Note F)

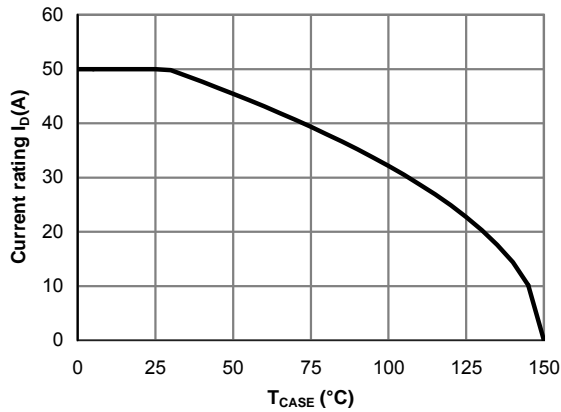

Figure 14: Current De-rating (Note F)

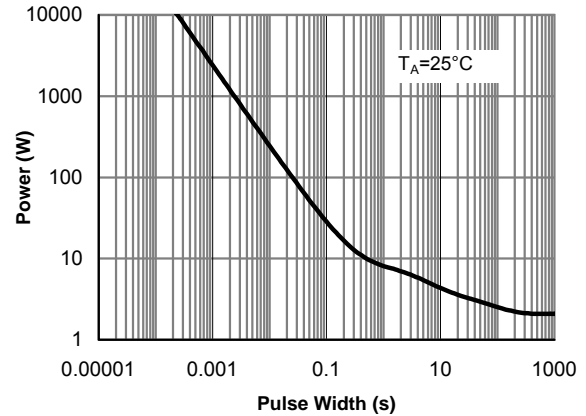

Figure 15: Single Pulse Power Rating Junction-to-Ambient (Note G)

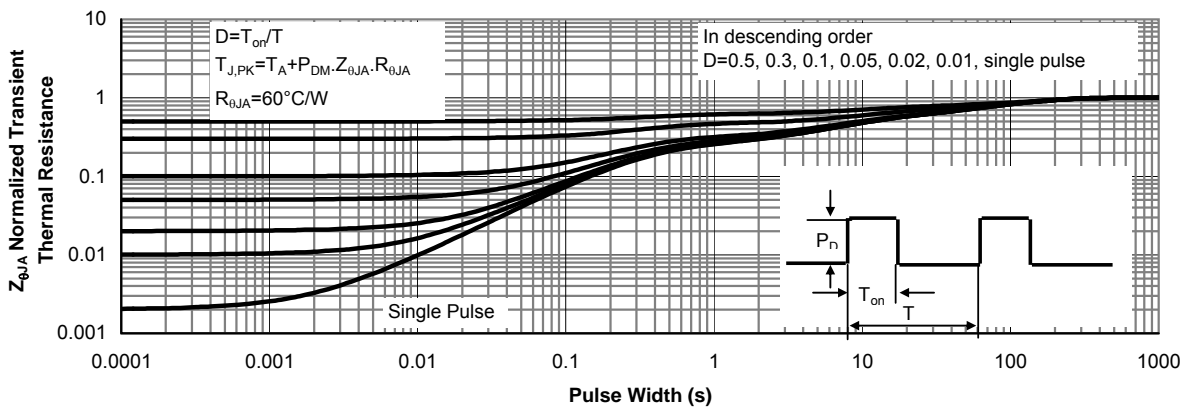
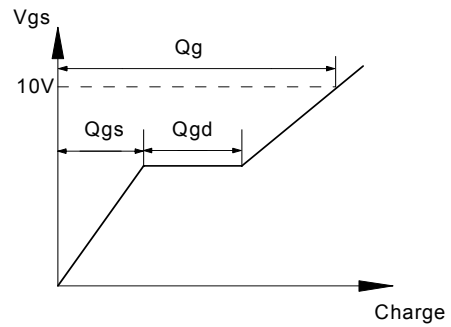
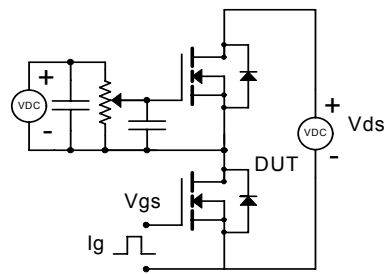
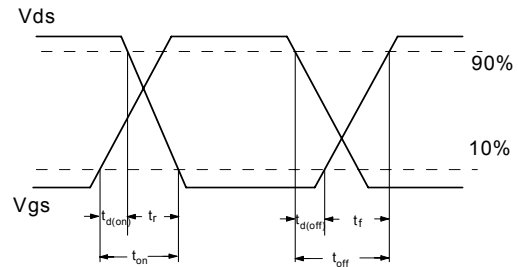
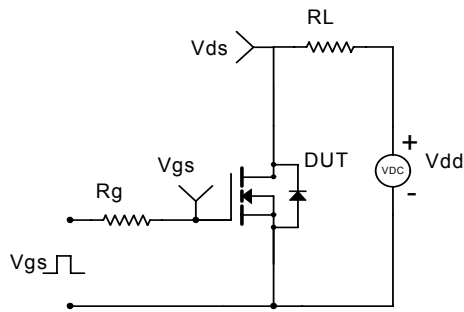

Figure 16: Normalized Maximum Transient Thermal Impedance (Note G)

Gate Charge Test Circuit & Waveform



Resistive Switching Test Circuit & Waveforms



Unclamped Inductive Switching (UIS) Test Circuit & Waveforms

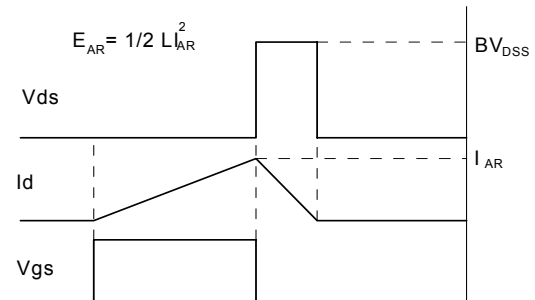
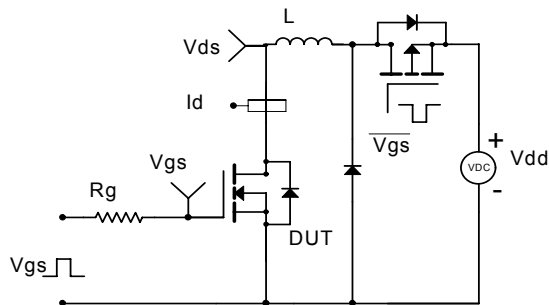

Diode Recovery Test Circuit & Waveforms

